



# LEICA M10-R

## QUICK START GUIDE



Download the full scope instruction manual here:

**[en.leica-camera.com/Service-Support/Support/Downloads](https://en.leica-camera.com/Service-Support/Support/Downloads)**

Please register via the following link if you would like to receive a printed copy of the full scope instruction manual:

**[www.order-instructions.leica-camera.com](https://www.order-instructions.leica-camera.com)**

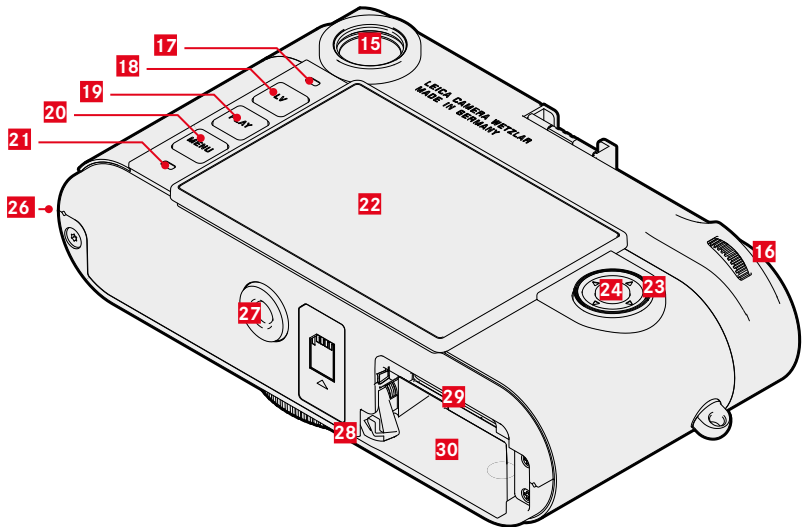
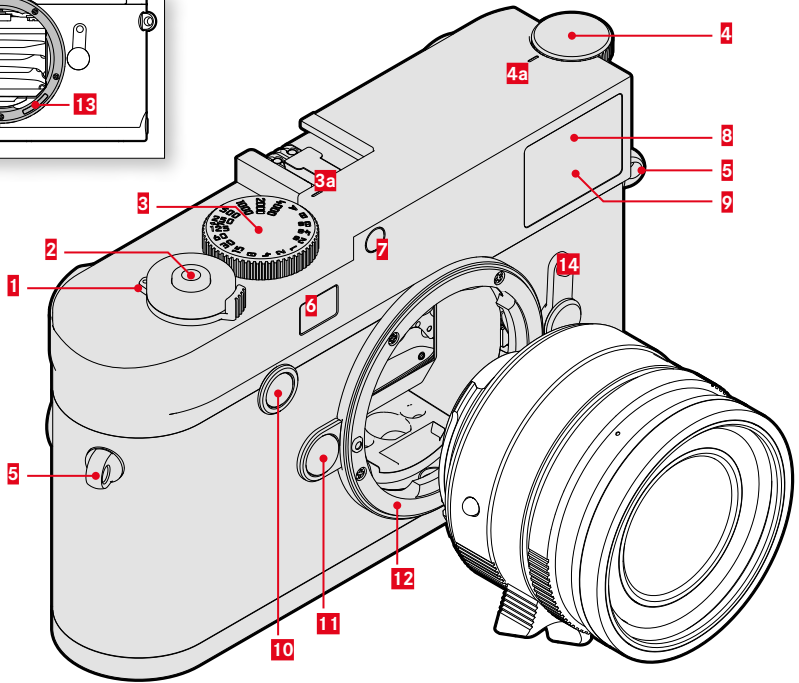
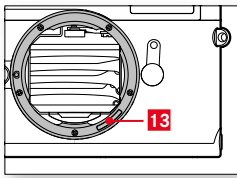

**1 Main switch**

Switching the camera ON/OFF

**2 Shutter button**

Tap:

- Activating exposure metering and exposure control

Press down fully:

- Shutter release

in standby mode:

- The camera is reactivated

**3 Shutter speed setting dial with stop positions**

- **A:** Automatic shutter speed control
- **8s - 4000:** Shutter speeds (inc. intermediate values)
- **B:** Long-time exposure (8 s - 16 min, via menu control, in full increments or Bulb)
- **⚡:** Flash sync speed (1/180 s)

**a** Index

**4 ISO setting wheel**

- **A:** Automatic ISO sensitivity control
- **100 - 6400:** Fixed ISO values
- **M:** Manual ISO sensitivity control

**a** Index

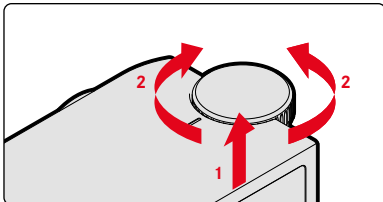

**5 Strap lugs**

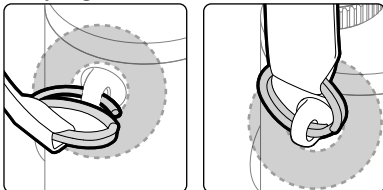

**6 Rangefinder window**

**7 Brightness sensor**

**8 Self-timer LED**

**9 Viewfinder window**

**10 Focus button**

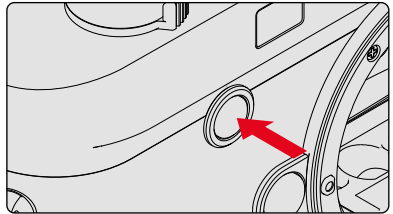

**11 Lens release button**

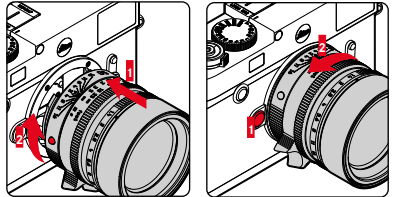

**12 Bayonet fitting**

**13 6-bit encoding**

Sensor for lens detection

**14 Image field selector**

Selection of bright-line frame pairs

35/135 mm, 50/75 mm and 28/90 mm

**15 Viewfinder eyepiece**

**16 Thumbwheel**

in the menu:

- Menu navigation
- Setting selected menu items/functions

in recording mode:

- Exposure compensation value selection

in review mode:

- Enlarging/reducing viewed pictures
- Scrolling through the picture memory (PLAY button pressed and held)

**17 Brightness sensor for LCD panel**

**18 LV button**

Activating/deactivating the Live View mode

**19 PLAY button**

- Switchover between picture and playback/review mode
- Return to full-screen display

**20 MENU button**

in the menu:

- Accessing the **FAVORITES** or **MAIN MENU**
- Exiting the currently displayed (sub) menu

**21 Status LED****22 LCD panel****23 Directional pad**

in the menu:

- Menu navigation
  - Setting selected menu items/functions
- in **review mode**:
- Scrolling through the picture memory

**24 Center button**

in the menu:

- Applying menu settings
- in **Playback/Review mode**:
- Accessing the status display

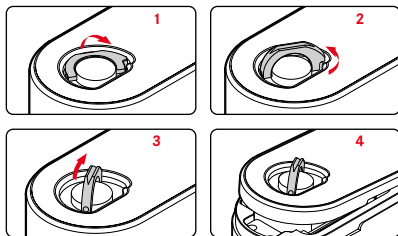
**25 Locking toggle for bottom cover****26 Bottom cover locking point****27 Tripod thread**

A ¼, DIN 4503 (¼")

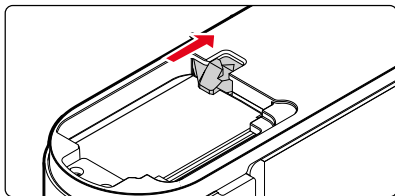
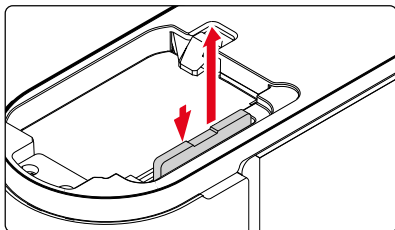
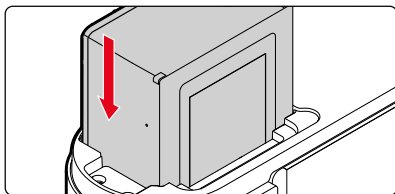
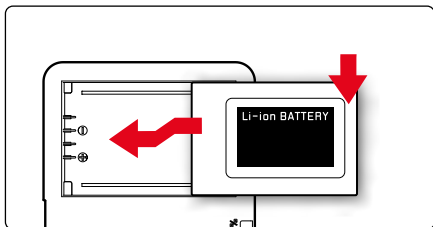
**28 Battery locking latch****29 Memory card slot****30 Battery compartment****CHARGING THE BATTERY**

A flashing green status LED indicates a correctly functioning charging process. A fully charged battery is indicated by a steady green light.

## DISPLAYS IN THE VIEWFINDER

The bright-line rangefinder in this camera is more than just a very bright viewfinder – it also is a lens-coupled rangefinder. All Leica M lenses with focal lengths between 16 and 135 mm are coupled automatically.

35 mm / 135 mm

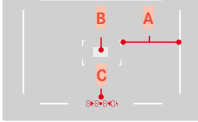

28 mm / 90 mm



- A** Bright-line frame
- B** Metering field for focusing
- C** Digital display

50 mm / 75 mm



## FOCUSING

### SUPERIMPOSED IMAGE METHOD (DOUBLE IMAGE)

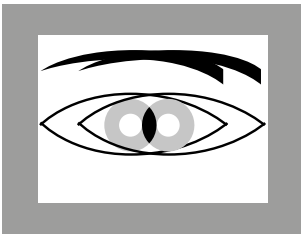

out of focus

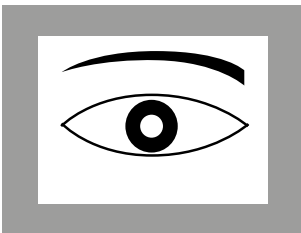

in focus

## DISPLAYS ON THE LCD PANEL



- 1** Battery capacity
- 2** Light balance
- 3** Remaining memory card capacity
- 4** ISO Sensitivity
- 5** Exposure compensation scale
- 6** Shutter speed
- 7** White balance
- 8** File format/compression level/resolution
- 9** Exposure metering method
- 10** Shutter button/Drive Mode
- 11** WLAN status
- 12** GPS status
- 13** User profile
- 14** Exposure mode
- 15** Light intensity/focal length or lens type
- 16** Remaining number of pictures

### SPLIT IMAGE METHOD

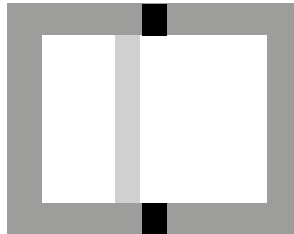

out of focus

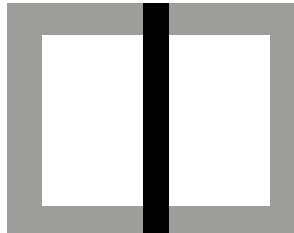

in focus

## GESTURE CONTROL



tap briefly



Tap twice



horizontal /vertical swipe



Two-finger pinch



Two-finger spread

## RECORDING

### FOCUS ASSIST IN LIVE VIEW



### SHIFT FOCUS POINT FOR FOCUS AID<sup>1</sup> AND EXPOSURE METERING<sup>2</sup>

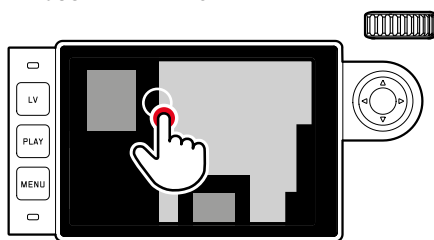

<sup>1</sup> Focus Aid is activated by turning the lens

<sup>2</sup> In combination with spot metering.

## REVIEW/PLAYBACK

### SWITCHING BETWEEN PICTURE MODE/ REVIEW MODE



### ZOOM IN/ZOOM OUT

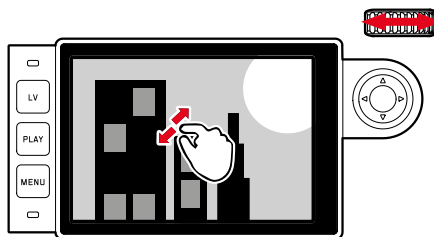

### SCROLL

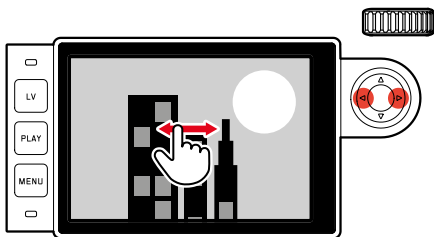

### DELETE/RATE



All other operations are accessible by invoking the relevant function from the menu list.

## MENU OVERVIEW

	Factory settings FAVORITES	Available for FAVORITES
Lens Detection		●
Drive Mode	●	●
Exp. Metering		●
Exp. Compensation	●	●
Flash Settings	●	●
ISO Setup	●	● M-ISO also available
White Balance	●	●
File Format	●	●
JPG Settings	●	● JPG Resolution also available
Auto Review		●
Capture Assistants		●
EVF/Display Control		●
User Profiles		● Load Profile also available
Customize Control		●
Display Brightness		●
EVF Brightness		●
Auto Power Saving		●
Leica FOTOS		●
GPS <sup>1</sup>		●
Date & Time		●
Language		●
Reset Camera		●
Format SD		●
Image Numbering		●
Sensor Cleaning		●
Camera Information		●

<sup>1</sup> This menu item is only available if the Leica Visoflex viewfinder is attached (available as an accessory).

# TECHNICAL DATA

## CAMERA

### Designation

Leica M10-R

### Camera type

Digital camera with rangefinder system

### Type no.

6376

### Order No.

20 002 (black), 20 003 (silver)

### Buffer memory

DNG™: 10 recordings

### Storage medium

SD cards 1-2 GB / SDHC cards up to 32 GB / SDXC cards up to 512 GB

### Material

Top cover and bottom cover: brass, black chrome-plated finish  
Front and rear housing panels: magnesium

### Lens mount

Leica M bayonet

### Compatible lenses

Leica M lenses, Leica R lenses via adapter

### Operating conditions

0/+40°C

### Dimensions (WxHxD)

139 x 38.5 x 80 mm

### Weight

approx. 675 g (with battery)

## SENSOR

### Sensor size

CMOS chip, active surface approx. 24 x 36 mm

### Picture resolution

DNG™: 7864 x 5200 pixels (40.89 MP)  
JPG: 7840 x 5184 pixels (40.64 MP),  
5472 x 3648 pixels (20 MP), 2976 x 1984 pixels  
(6 MP)

## VIEWFINDER/LCD PANEL

### Viewfinder

Large, bright-line rangefinder with automatic parallax compensation

### LCD panel

3" TFT LCD, 1,036,800 dots, touch control available

## EQUIPMENT

### WLAN

The Leica FOTOS app is required to use the WLAN function. The Leica app is available from the Apple App Store™ or the Google Play Store™. Complies with IEEE 802.11b/g/n standard (standard WLAN protocol), channel 1-11, encryption method: WLAN-compatible WPA™/WPA2™, access method: infrastructure mode

### Menu languages

English, German, French, Italian, Spanish, Russian, Japanese, Simplified Chinese, Traditional Chinese, Korean, Portuguese

## POWER SUPPLY

### Rechargeable battery (Leica BP-SCL5)

1 lithium-ion rechargeable battery, rated voltage 7.4 V; capacity 1100 mAh, max. charging voltage/current: 1000 mADC, 7.4 V; operating conditions (in the camera): +0 to +40°C; manufacturer: PT. VARTA Microbattery, Made in Indonesia

### Charger (Leica BC-SCL5)

Inputs: 100-240 VAC, 50/60 Hz, 300 mA with automatic switch-over or 12 VDC, 1.3 A; output: DC, rated voltage 7.4 V, 1000 mA / max. 8.25 V, 1100 mA; operating conditions: +10 to +35°C; manufacturer: Guangdong PISEN Electronics Co. Ltd., Made in China

You will find the manufacturing date of your camera on the stickers in the Warranty Card and/or on the packaging. The date format is year/month/day. Subject to changes in design and production.



# SAFETY REMARKS

## GENERAL INFORMATION

- Do not use your camera in the immediate vicinity of devices that generate powerful magnetic, electrostatic or electromagnetic fields (e.g. induction ovens, microwave ovens, television sets or computer screens, video game consoles, cell phones, broadcasting equipment). Their electromagnetic fields can interfere with recordings.
- Strong magnetic fields, e.g. from speakers or large electric motors can damage the stored picture data or disrupt recording.
- Switch off the camera, remove the battery briefly, replace it and switch the camera back on in case of a camera malfunction due to the effects of electromagnetic fields.
- Do not use the camera in the immediate vicinity of radio transmitters or high-voltage power lines. Their electromagnetic fields may interfere with recordings.
- Always store small parts e.g. the accessory shoe cover as follows:
  - out of the reach of children
  - in a safe location, where they will not get lost or stolen
- State-of-the-art electronic components are sensitive to static discharge. Since people can easily pick up charges of several 10,000 volts by walking on synthetic carpets, a discharge can occur when you touch the camera, and especially it is placed on a conductive surface. A static discharge on the camera housing poses no risk for the electronics. Despite built-in safety circuits, you should avoid direct contact with external camera contacts like those in the flash shoe.
- Take care not to soil or scratch the sensor for lens detection in the bayonet. You must similarly prevent direct contact of the bayonet with grains of sand or similar particles, as these could cause irreparable damage. This component must only be cleaned with a dry cloth (in system cameras).
- Use a cotton or linen cloth instead of a microfiber cloth from an optician's (synthetic) when cleaning the contacts. Make sure to discharge any electrostatic charge by deliberately touching a heating or water pipe (conductive, grounded material). Dirt deposits and oxidation on the contacts can be avoided by storing your camera in a dry location with the lens cap and the flash shoe/viewfinder cap (in system cameras) attached.
- Only use accessories specified for this model to prevent faults, short circuits or electric shock.
- Do not attempt to remove parts of the housing (covers) yourself. Repairs must be done at authorized service centers only.
- Protect the camera against contact with insect sprays and other aggressive chemicals. Petroleum spirit, thinner and alcohol must not be used for cleaning. Some chemicals and liquids can damage the camera housing or the surface finish.
- Rubber and plastics are known to expel aggressive chemicals and should therefore not be kept in contact with the camera for extended periods of time.
- Prevent any sand or dust or water penetration into the camera, e.g. during snowfall or rain or on the beach. Be extra careful when changing the lens (in system cameras) and when inserting or removing the memory card and rechargeable battery. Sand and dust can damage the camera, the lens, the memory card and the battery. Moisture can cause malfunctions and irreparable damage to the camera and memory card.

## LENS

- A camera lens can have the effect of a magnifying glass when exposed to direct frontal sunlight. The camera must therefore be protected against extended exposure to direct sunlight.
- Attaching the lens cap and keeping the camera in the shade or ideally in its camera case, will help prevent damage to the interior of the camera.

## RECHARGEABLE BATTERY

- Improper use of the batteries or the use of unapproved battery types may result in an explosion!
- Do not expose the rechargeable battery to sunlight, heat, humidity or moisture for prolonged periods of time. Likewise, the batteries must not be placed in a microwave oven or a high-pressure container as this would pose a fire or explosion hazard.
- Do not under any circumstances charge or insert a damp or wet battery into the camera!
- A safety valve in the battery ensures that any excess pressure caused by improper handling is discharged safely. It is nevertheless important to dispose of a bloated battery immediately. It may pose an explosion hazard!
- Keep the battery contacts clean and easily accessible. Although lithium-ion batteries are secured against short circuits, they should still be protected against contact with metal objects like paper clips or jewelry. A short-circuited battery can get very hot and cause severe burns.

- When a battery is accidentally dropped, make sure to check the housing and the contacts immediately for any damage. A damaged battery can damage the camera.
- The battery must be removed from the camera or charger and must be replaced immediately in case of a strange smell, discoloration, deformation, overheating or leakage. Continued use of the battery may result in overheating, which can cause fire and/or explosion!
- Never throw batteries into a fire as they may explode.
- Keep the battery away from sources of heat in case of leakage or if you smell burning. Leaked fluid can catch fire!
- The use of other chargers not approved by Leica Camera AG can cause damage to the batteries – and in extreme cases – cause serious or life-threatening injuries.
- Make sure that the power socket is freely accessible at all times.
- The in-car charging cable must never be connected while the charger is connected to mains electricity.
- Do not attempt to open the battery or the charger. Repairs must only be carried out by authorized service centers.
- Keep batteries out of the reach of children. Batteries can cause suffocation when swallowed.

## **CHARGER**

- Using the charger in the vicinity of broadcasting receivers may interfere with reception. Ensure a distance of at least 1 m (3 ft) between the charger and the receiver.
- When the charger is in use, it may emit a buzzing sound – this is normal and not a malfunction.
- Disconnect the charger from the mains when it is not in use, as it consumes electricity (a very small amount), even if no battery is inserted.
- Always keep the charger contacts clean, and never short circuit them.
- The in-car charging cable must only be operated in 12V in-car grids and must never be connected while the charger is connected to mains electricity.

## **MEMORY CARD**

- Never remove the memory card during a datasave or card reading process. The camera must not be switched off or be subjected to impact or vibrations while working.
- Do not open the cover/remove the memory card or the battery while the status LED is lit, which indicates memory access. Data on the card may otherwise be destroyed and camera malfunctions may occur.
- Do not drop or bend memory cards as this will cause damage and result in the loss of stored data.
- Do not touch the connections on the reverse of the memory card and keep them clean and dry.
- Keep memory cards out of the reach of children. Swallowing a memory card may cause suffocation.

## **SENSOR**

Cosmic radiation (e.g. during flights) may cause pixel defects.

## **CARRY STRAP**

- Once you have attached the carry strap, please make sure that the clips are mounted correctly to prevent the camera from falling.
- Carry straps are usually made of very robust material. You should therefore keep it out of the reach of children. A carry strap is not a toy and poses a strangulation risk.
- Use the carry strap only for its intended purpose on a camera or on binoculars. Any other use poses the risk of injury and may possibly result in damage to the carry strap and is therefore not permitted.
- Carry straps should also not be used for cameras/binoculars during sports activities that pose a risk of entanglement (e.g. when mountain climbing and similar outdoor activities).

## **TRIPOD**

- When using a tripod, make sure it is standing securely and turn the camera only by turning the tripod, not the actual camera.
- Ensure that the tripod screw is hand-tightened only.
- Avoid transporting the camera while the tripod is attached. You might injure yourself or others and the camera could get damaged.



## **FLASH**

The use of incompatible flash units with your Leica M10 Monochrom may result in irreparable damage to the camera and/or the flash unit.

## REGULATORY INFORMATION

Specific regional approvals for this device can be found in the camera menu.

- ▶ Select **Camera Information** in the main menu
- ▶ Select **Regulatory Information** in the submenu

 Alternating current (AC)	 Class II devices (the product has a double-insulated design)
 Direct current (DC)	



## DISPOSAL OF ELECTRICAL AND ELECTRONIC EQUIPMENT

(Applies within the EU and for other European countries with active waste separation policies)

This device contains electric and/or electronic components which must not be disposed of in general household waste. Instead, it should be disposed of at a recycling collection point provided by your local authority. This service is free of charge. Any standard or rechargeable batteries used in this device must be removed and disposed of separately in accordance with local regulations.

Please contact your local authorities, waste disposal collection point or the retailer, from whom you purchased the device for more information on correct waste disposal.

## WARRANTY

In addition to your statutory warranty rights regarding your dealer, you will receive an additional Leica Camera AG product warranty valid from the date of purchase at an authorized Leica retailer.

Previously, the product warranty was included with the product in the packaging. From now on, the product warranty will only be available online as a new service. You will be able to review the warranty conditions for your product at any time, without having to search for the document. Please note that this new policy applies only for products that are no longer delivered with a hardcopy product warranty included in the packaging. Any products delivered with the warranty document in the packaging are still subject to that particular document. For more information regarding the warranty scope, services and limitations, please visit: [warranty.leica-camera.com](http://warranty.leica-camera.com)

## FOR EU ONLY:

### English

#### Declaration of Conformity (DoC)

Hereby, "Leica Camera AG" declares that this product is in compliance with the essential requirements and other relevant provisions of Directive 2014/53/EU.

Customers can download a copy of the original DoC to our Radio Equipment products from our DoC server:

[www.cert.leica-camera.com](http://www.cert.leica-camera.com)

In case of further questions, please contact:

Leica Camera AG, Am Leitz-Park 5, 35578 Wetzlar, Germany

#### Product dependent (see technical data)

Type	Frequency band (central frequency)	Maximum power (dBm E.I.R.P.)
WLAN	2412-2462/5180-5240 MHz/	20
	5260-5320/5900-5700 MHz	
Bluetooth® Wireless Technology	2402-2480 MHz	20

**The CE mark on our products documents compliance with the fundamental requirements of applicable EU directives.**

## FOR US ONLY:

### FCC Note:

This equipment has been tested and found to comply with the limits for a Class B digital device, pursuant to Part 15 of the FCC Rules. These limits are designed to provide reasonable protection against harmful interference in a residential installation. This equipment generates, uses, and can radiate radio frequency energy and, if not installed and used in accordance with the instructions, may cause harmful interference to radio communications. However, there is no guarantee that interference will not occur in a particular installation. If this equipment does cause harmful interference to radio or television reception, which can be determined by turning the equipment off and on, the user is encouraged to try to correct the interference by one or more of the following measures:

- Reorient or relocate the receiving antenna.
- Increase the separation between the equipment and receiver.
- Connect the equipment into an outlet on a circuit different from that to which the receiver is connected.
- Consult the dealer or an experienced radio/TV technician for help.

### FCC Caution:

To assure continued compliance, follow the attached installation instructions and use only shielded interface cables with ferrite core when connecting to computer or peripheral devices. Any changes or modifications not expressly approved by the party responsible for compliance could void the user's authority to operate this equipment.

### Declaration of Conformity

Trade Name: Leica

Model No.: 6376

Responsible party/Support contact: Leica Camera Inc.

1 Pearl Court, Unit A

Allendale, New Jersey 07401

Tel.: +1 201 995 0051

Fax: +1 201 995 1684

technicalinfo@leicacamerausa.com

This device complies with Part 15 of the FCC Rules. Operation is subject to the following two conditions: (1) This device may not cause harmful interference, and (2) this device must accept any interference received, including interference that may cause undesired operation.

### FCC ID: N5A6376

This transmitter must not be co-located or operated in conjunction with any other antenna or transmitter. This equipment complies with FCC radiation exposure limits set forth for an uncontrolled environment and meets the FCC radio frequency (RF) Exposure Guidelines.

This equipment is tested for specific absorption ratio (SAR) and complies with FCC/IC radiation exposure limits set forth for an uncontrolled environment. This device complies with FCC/IC SAR limit of 1.6 W/kg. For body worn operation, this equipment has been tested and meets the FCC/IC RF exposure guidelines when used with the Leica Camera AG accessories supplied or designated for this product that have no metallic component in the assembly. Use of other accessories may not ensure compliance with FCC/IC RF exposure guidelines.

### FOR CANADA ONLY:

CAN ICES-3 (B)/NMB-3(B)

This device complies with RSS-210 of the IC Rules. Operation is subject to the following two conditions:

(1) This device may not cause harmful interference,

(2) This device must accept any interference received,

including interference that may cause undesired operation of the device. This equipment complies with IC radiation exposure limits set forth for an uncontrolled environment and meets RSS-102 of the IC radio frequency (RF) Exposure rules. This equipment is tested for specific absorption ratio (SAR) and complies with FCC/IC radiation exposure limits set forth for an uncontrolled environment. This device complies with FCC/IC SAR limit of 1.6 W/kg. For body worn operation, this equipment has been tested and meets the FCC/IC RF exposure guidelines when used with the Leica Camera AG accessories supplied or designated for this product that have no metallic component in the assembly. Use of other accessories may not ensure compliance with FCC/IC RF exposure guidelines.