



**LEICA SL3**  
Instruction manual



## FOREWORD

Dear Customer,

We wish you a great deal of fun and success taking photographs with your new Leica SL3. Please read this manual thoroughly to familiarize yourself with the full scope of functions your camera has to offer. You can find all information about the Leica SL3 whenever you need it at <https://leica-camera.com>.

Your Leica Camera AG

## SCOPE OF DELIVERY

Before using your camera for the first time, please check that the accessories supplied are complete.

- Leica SL3
- Lithium-ion rechargeable battery Leica BP-SCL6
- USB-C cable
- Camera bayonet cover
- Carry strap
- Quick Start Guide
- CE flyer
- Flyer (Leica account)
- Test certificate

Subject to changes in design and model features.

## REPLACEMENT PARTS / ACCESSORIES

Please contact Leica Customer Care or visit the Leica Camera AG website for information on the extensive range of Leica replacement parts/accessories:

<https://leica-camera.com/en-US/photography/accessories>

Only the accessories specified and described in this manual or by Leica Camera AG must be used with the camera (battery, charger, mains plug, mains cable, etc.). These accessories must only be used with this product. Third-party accessories may result in malfunctions or damage to the product.

Please read the chapters “Legal information”, “Safety remarks”, and “General information” before using your camera for the first time. Knowledge of the content will prevent inadvertent damage to the product, possible injuries and other risks.



**COPYRIGHT NOTICE**

- Compliance with copyright laws is mandatory. The recording and publication of pre-recorded media like tapes, CDs, or other published or broadcast material may breach copyright laws. The same applies for all software supplied as part of the scope of delivery.
- The following applies for all video material created with this camera: This product is governed by the AVC Patent Portfolio license and is meant for private use by a consumer only. The device may furthermore be used for purposes for which the consumer receives no remuneration, e.g. (i) encoding in accordance with the AVC Standard (“AVC Video”) and/or (ii) decoding of AVC Video that was encoded by a consumer in accordance with the AVC Standard within the scope of personal use and/or which the consumer has received from the provider, who is in possession of a license to offer AVC Video. No license is granted or implied for any other use. Any other use, specifically the provision of AVC video in exchange for remuneration, may require a separate license agreement with MPEG LA, L.L.C. Please visit the MPEG LA, L.L.C. website at: [www.mpegla.com](http://www.mpegla.com) for more information.
- The designations SD, SDHC, SDXC, microSDHC and their associated logos are registered trademarks of SD-3C, LLC.

**COPYRIGHT**

All rights reserved.

All text, images and graphics are subject to copyright and other laws to protect intellectual property. They must not be copied, modified or used for any purpose including trade purposes.

**TECHNICAL DATA**

Product changes with regards to the products or services may occur after the editorial deadline. The manufacturer reserves the right to effect structural or shape changes, color deviations and changes to the scope of delivery or service, where these changes or deviations are reasonably acceptable for the customer, while taking into consideration the interests of Leica Camera AG. To that extent, Leica Camera AG reserves the right to changes and errors. The images in this manual may depict accessory, special features or other items that are not part of the standard scope of delivery or service. Some pages may contain model types and services, which are not offered in specific countries.

## BRANDS AND LOGOS

The brand names and logos used in this document are protected trademarks. These brands or logos must not be used without prior approval by Leica Camera AG.

## LICENSE RIGHTS

Leica Camera AG intends to provide you with innovative and informative documentation. Due to the amount of creativity that has gone into its design, we ask for your understanding that Leica Camera AG must protect its intellectual property, including patents, trademarks and copyrights, and that possession of the documentation does not infer any licensing rights of the intellectual property of Leica Camera AG.

## REGULATORY INFORMATION

You will find the manufacturing date of your camera on the stickers in the Warranty Card and/or on the packaging. The date format is year/month/day.

## COUNTRY-SPECIFIC LICENSES

Specific regional approvals for this device can be found in the camera menu.

- ▶ Select **Camera Information** in the main menu
- ▶ Select **Regulatory Information**

## LICENSE INFORMATION

The device-specific license information can be found in the camera menu.

- ▶ Select **Camera Information** in the main menu
- ▶ Select **License Information**



## CE MARK

The CE mark on our products documents compliance with the fundamental requirements of applicable EU guidelines.

### Declaration of Conformity (DoC)

"Leica Camera AG" hereby declares that this product is in compliance with the basic requirements and other relevant provisions of Directive 2014/53/EU.

Customers can download a copy of the original DoC for our Radio Equipment products from our DoC server:

[www.cert.leica-camera.com](http://www.cert.leica-camera.com)

Please contact Leica Camera AG, Am Leitz-Park 5, 35578 Wetzlar, Germany in case of any further questions

Usable frequency band/Usage limitations:

see Technical Data

Maximum output (e.i.r.p.): WLAN: <20 dBm / Bluetooth: <10 dBm

## DISPOSAL OF ELECTRICAL AND ELECTRONIC EQUIPMENT

(Applies within the EU and for other European countries with active waste separation policies.)



This device contains electrical and/or electronic components which must not be disposed of in general household waste. Instead, it should be disposed of at a recycling collection point provided by your local authority.

This service is free of charge. Any standard or rechargeable batteries used in this device must be removed and disposed of separately in accordance with local regulations.

Please contact your local authorities, waste disposal collection point or the retailer, from whom you purchased the device for more information on correct waste disposal.

## IMPORTANT NOTES REGARDING THE USE OF WLAN/BLUETOOTH®

- Appropriate measures must be taken to ensure security and protect against disruptions to the systems in place where devices or computer systems are in use that require more stringent security than WLAN devices.
  - Leica Camera AG shall not accept liability for damages arising from the use of the camera for purposes other than as a WLAN device.
  - It is assumed that the WLAN function will be used in countries where this camera is sold. There may be a risk of breaching statutory wireless communication regulations when using the camera in other countries. Leica Camera AG shall not accept liability for such breaches.
  - Please note that there is a risk of unauthorized third party interception of wirelessly communicated data. We highly recommend that you activate encryption in the wireless access point settings to ensure data safety.
  - Avoid using the camera in areas where it can be exposed to magnetic fields, static electricity or other interferences, e.g. near a microwave oven. RF transmissions may otherwise not reach the camera.
  - Using the camera near devices like microwave ovens or wireless phones that use the 2.4 GHz RF band may negatively affect the performance of both devices.
  - Do not attempt to connect to wireless networks you are not authorized to use.
  - The device will automatically search for wireless networks, once the WLAN function is enabled. A list, including networks you are not authorized to access, will be displayed (SSID: Network identifier for a WLAN network). Do not attempt to connect to third party network, as this could be construed as unauthorized access.
- We recommend disabling the WLAN function while on an aircraft.
  - The use of the WLAN-RF band between 5150 MHz and 5350 MHz is permitted only in enclosed spaces.
  - Please read the important notes on specific functions of Leica FOTOS on p. 294.

## SAFETY REMARKS

### GENERAL INFORMATION

- Do not use your camera in the immediate vicinity of devices that generate powerful magnetic, electrostatic or electromagnetic fields (e.g. induction ovens, microwave ovens, television sets or computer screens, video game consoles, cell phones, broadcasting equipment). Their electromagnetic fields can interfere with image capturing.
- Strong magnetic fields, e.g. from speakers or large electric motors can damage the stored data or disrupt shooting.
- Switch off the camera, remove the battery briefly, replace it and switch the camera back on in case of a camera malfunction due to the effects of electromagnetic fields.
- Do not use the camera in the immediate vicinity of radio transmitters or high-voltage power lines. Their electromagnetic fields may also interfere with image capturing.
- Always store small parts e.g. the accessory shoe cover as follows:
  - out of the reach of children
  - in a safe location, where they will not get lost or stolen
- State-of-the-art electronic components are sensitive to static discharge. You can easily pick up charges of several 10,000 volts by simply walking on synthetic floor coverings. A static discharge can occur when you touch the camera and especially if it is placed on a conductive surface. A static discharge on the camera housing poses no risk for the electronics. Despite built-in safety circuits, you should avoid direct contact with external camera contacts like those in the flash shoe.
- Take care not to soil or scratch the sensor for lens detection in the bayonet. You must similarly prevent direct contact of the bayonet with grains of sand or similar particles, as these could cause irreparable damage. This component must only be cleaned with a dry cloth (in system cameras).
- Use a cotton or linen cloth instead of a microfiber cloth from an optician's (synthetic) when cleaning the contacts. Make sure to discharge any electrostatic charge by deliberately touching a heating or water pipe (conductive, grounded material). Dirt deposits and oxidation on the contacts can be avoided by storing your camera in a dry location with the lens cap and the flash shoe/viewfinder cap (in system cameras) attached.
- Only use accessories specified for this model to prevent faults, short circuits or electric shock.
- Do not attempt to remove parts of the housing (covers) yourself. Repairs must be done at authorized service centers only.
- Protect the camera against contact with insect sprays and other aggressive chemicals. Petroleum spirit, thinner and alcohol must not be used for cleaning. Some chemicals and liquids can damage the camera housing or the surface finish.
- Rubber and plastics are known to expel aggressive chemicals and should therefore not be kept in contact with the camera for extended periods of time.
- Prevent any sand or dust or water penetration into the camera, e.g. during snowfall or rain or on the beach. Be extra careful when changing the lens (in system cameras) and when inserting or removing the memory card and rechargeable battery. Sand and dust can damage the camera, the lens, the memory card and the battery. Moisture can cause malfunctions and irreparable damage to the camera and memory card.



## LENS

- A camera lens can have the effect of a magnifying glass when exposed to direct frontal sunlight. The camera must therefore be protected against extended exposure to direct sunlight.
- Attaching the lens cap and keeping the camera in the shade or ideally in its camera case, will help prevent damage to the interior of the camera.

## RECHARGEABLE BATTERY

- Improper use of the batteries or the use of unapproved battery types may result in an explosion!
- Do not expose the rechargeable battery to sunlight, heat, humidity or moisture for prolonged periods of time. Likewise, the batteries must not be placed in a microwave oven or a high-pressure container as this would pose a fire or explosion hazard!
- Do not under any circumstances charge or insert a damp or wet battery into the camera!
- A safety valve in the battery ensures that any excess pressure caused by improper handling is discharged safely. It is nevertheless important to dispose of a bloated battery immediately. It may pose an explosion hazard!
- Keep the battery contacts clean and easily accessible. Although lithium-ion batteries are secured against short circuits, they should still be protected against contact with metal objects like paper clips or jewelry. A short-circuited battery can get very hot and cause severe burns.
- When a battery is accidentally dropped, make sure to check the housing and the contacts immediately for any damage. A damaged battery can damage the camera.
- The battery must be removed from the camera or charger and must be replaced immediately in case of a strange smell, discoloration, deformation, overheating or leakage.

oration, deformation, overheating or leakage. Continued use of the battery may result in overheating, which can cause fire and/or explosion!

- Never throw batteries into a fire as they may explode.
- Keep the battery away from sources of heat in case of leakage or if you smell burning. Leaked fluid can catch fire!
- The use of other chargers not approved by Leica Camera AG can cause damage to the batteries – and in extreme cases – cause serious or life-threatening injuries.
- Make sure that the power socket is freely accessible at all times.
- Do not attempt to open the battery or the charger. Repairs must only be carried out by authorized workshops.
- Keep batteries out of the reach of children. Batteries can cause suffocation when swallowed.

### FIRST AID

- Battery fluid may cause blindness if it comes into contact with the eyes. Rinse the eyes thoroughly with clean water immediately. Avoid rubbing. Seek medical attention immediately.
- Leaked battery fluid poses an injury hazard when it comes in contact with clothing or skin. Rinse the affected areas thoroughly with clean water.

## CHARGER

- Using the charger in the vicinity of broadcasting receivers may interfere with reception. Ensure a distance of at least 1 m between the charger and the receiver.
- When the charger is in use, it may emit a buzzing sound – that is normal and not a malfunction.

- Disconnect the charger from the mains when it is not in use, as it consumes electricity (a very small amount), even if no battery is inserted.
- Always keep the charger contacts clean, and never short-circuit them.

## MEMORY CARD

- Never remove the memory card during a data save or card reading process. The camera must not be switched off or be subjected to impact or vibrations while working.
- Do not open the cover/remove the memory card or the battery from the camera while the status LED is lit, which indicates memory access. Data on the card may otherwise be destroyed and camera malfunctions may occur.
- Do not drop or bend memory cards as this will cause damage and result in the loss of stored data.
- Do not touch the connections on the reverse of the memory card and keep them clean and dry.
- Keep memory cards out of the reach of children. Swallowing a memory card may cause suffocation.

## SENSOR

- Cosmic radiation (e.g. during flights) may cause pixel defects.

## CARRY STRAP

- Carry straps are usually made of very robust material. You should therefore keep it out of the reach of children. A carry strap is not a toy and poses a strangulation risk.
- Use the carry strap only for its intended purpose on a camera or on binoculars. Any other use poses the risk of injury and may

possibly result in damage to the carry strap and is therefore not permitted.

- Carry straps should also not be used for cameras/binoculars during sports activities that pose a risk of entanglement (e.g. when mountain climbing and similar outdoor activities).

## TRIPOD

- When using a tripod, make sure it is standing securely and turn the camera only by turning the tripod, not the actual camera. Ensure that the tripod screw is hand-tightened only. Avoid transporting the camera while the tripod is attached. You might injure yourself or others and the camera could get damaged.

## FLASH

- The use of incompatible flash units with your Leica SL3 may result in irreparable damage to the camera and/or the flash unit.



## GENERAL INFORMATION

Please read the section about “Care/Storage” for more information about what to do in case of problems.

### CAMERA/LENS

- Make a note of the serial numbers of your camera (engraved in the base of the camera housing) and lenses, as this information will be extremely important in case of loss.
- Make sure to always have a lens or the camera bayonet cover attached to prevent dust or other foreign bodies penetrating the camera.
- That is why you should always replace lenses quickly and in a dust-free environment.
- Never store the camera bayonet cover or the lens back cover in a pants pocket, as they will attract lint and dust, which could then be accidentally introduced into the camera.

### LCD PANEL

- Condensation may form on the LCD panel if the camera is exposed to great temperature fluctuations. Wipe the screen carefully with a soft, dry cloth.
- The screen image will initially be slightly darker than normal if the camera is very cold when it is switched on. The normal level of brightness will be reached as soon as the LCD panel warms up.

### RECHARGEABLE BATTERY

- The rechargeable battery must only be charged within a specific temperature range. See chapter “Technical Data” (p. 332) for details about operating conditions.

- Lithium-ion batteries can be charged at any time, regardless of their current charge level. A partially charged battery will charge to full capacity faster than a fully discharged one.
- The rechargeable batteries come only partly charged ex works and should therefore be charged fully before their first use.
- A new battery only reaches its full capacity after it has been fully charged and – by using it in the camera – depleted 2 to 3 times. This depletion process should be repeated roughly every 25 cycles.
- Battery and charger heat up during the charging process. That is normal and not a malfunction.
- Rapid flashing of the two LEDs (> 2 Hz) when charging commences indicates a charging error (e.g. maximum charging time exceeded, voltages or temperatures outside permitted ranges or a short circuit). Disconnect the charger from the mains and remove the battery. Ensure that the above temperature conditions are met and then restart the charging process. Please contact your dealer, the Leica representative in your region or Leica Camera AG if the problem persists.
- Rechargeable lithium-ion batteries generate power by way of internal chemical reactions. These reactions are influenced by ambient temperature and humidity. Do not expose the battery to extreme temperatures (high or low) for extended periods of time (e.g. in a parked car in the summer or winter) to ensure a maximum service life.
- However, every battery has its limits – even in optimal conditions! After several hundred charging cycles, the operating times will get significantly shorter.
- The replaceable battery supplies power to a backup battery, which is permanently installed in the camera. This backup battery retains the date and time for some weeks. Once the backup battery is depleted, it must be replenished by inserting a charged

main battery. The time and date will have to be set again after a full depletion of both batteries.

- As the battery capacity deteriorates or if using an older battery, warning messages may appear and some functions may be restricted or blocked entirely.
- Always remove the battery if the camera will not be used for an extended period of time. Make sure to switch the camera off via the main switch before removing the battery. Leaving the battery in the camera will result in a deep discharge after a few weeks. Voltage levels will decrease significantly, as the camera uses a low idle current to maintain settings.
- Dispose of damaged batteries in accordance with the relevant regulations at an approved collection point for proper recycling.
- The date of manufacture can be found on the battery. The date format is week/year.

## MEMORY CARD

- The range of available SD/SDHC/SDXC cards on the market is too extensive for Leica Camera AG to test for compatibility and quality. Generally, any type of memory card may be used without any damage to the camera or memory card. As some “no name” cards may not fully comply with the SD/SDHC/SDXC standards, Leica Camera AG cannot provide any guarantee of function.
- We recommend formatting the memory card from time to time, as fragmented residual data from deleted files may block some of the storage capacity.
- Generally, it is not necessary to format (initialize) memory cards that have been previously used. Formatting will, however, be necessary if you insert an unformatted memory card or a card that was formatted in another device (e.g. a computer) for the first time.

- We recommend backing up your data on a PC, because electromagnetic fields, static electricity and any damage to the memory card or camera defects may result in irretrievable damage or loss of your data.
- SD, SDHC, and SDXC memory cards come with a write protection slider to prevent accidental overwriting. This slider is located on the non-beveled side of the card. All data on the card is protected when the slider is set to its lower position, marked LOCK.
- All data stored on the memory card will be lost during formatting. Formatting will not be prevented by a deletion protection set for individual shots.



### CAUTION: HOT MEMORY CARD

As depicted on the inside of the card compartment, the memory card may be hot directly after use by the camera. Be careful when removing the card! Do not remove the memory card directly if a high temperature warning is displayed on screen. Instead, please wait until the message is no longer displayed before removing the card.

## SENSOR

- Any dust or dirt particles stuck to the glass cover of the sensor may result in noticeable dark stains or specks on the images (in system cameras). Alternatively, send your camera to the Leica Customer Care department for sensor cleaning (see p. 340). This service is not part of the warranty offering and will therefore incur charges.

## DATA

- All data, including personal information, may be changed or deleted due to incorrect or accidental operation, static discharge, accidents, malfunctions, repairs and other measures.
- Please note that Leica Camera AG does NOT accept liability for direct or consequential damage due to the manipulation or destruction of data and personal information.

## FIRMWARE UPDATE

Leica is continuously working on the further improvement and optimization of Leica SL3. As digital cameras have many functions that are controlled electronically, improvements and enhancements to the functions can be installed on the camera at a later date. Leica releases so-called firmware updates at irregular intervals. Cameras are always supplied ex works with the latest firmware installed or you can download the latest version from our website yourself and transfer it to your camera.

You will receive a newsletter informing you of the availability of a new firmware update if you register your camera on the Leica Camera homepage.

Visit the download section or the “Customer Area” for information about how to register or how to get firmware updates for your Leica SL3. Additionally, you can find information about changes or additions to the manual at: <https://club.leica-camera.com>

Leica releases firmware updates for lenses at irregular intervals. You can download any new firmware version from our homepage and transfer it to your lens. Please see p. 289 for more information.

Select the menu item **Camera Information** (see p. 289) to check whether your camera and lenses are running the latest firmware version.



## WARRANTY TERMS LEICA CAMERA AG

Dear Leica Customer,

congratulations on the purchase of your new Leica product – you are now the proud owner of a world-class brand product.

In addition to your statutory warranty claims against your seller, we, Leica Camera AG ("LEICA"), grant you voluntary warranty services for your Leica product in accordance with the following stipulations ("Leica Warranty"). The Leica warranty therefore does not limit your statutory rights as a consumer under applicable law or your rights as a consumer against the dealer with whom you have concluded the purchase contract.

### LEICA WARRANTY

You have purchased a Leica product that has been manufactured according to special quality guidelines and tested by experienced specialists during the various stages of production. We provide the following Leica Warranty, valid as of April 1, 2023, for this Leica product and including the accessory parts in the original packaging. Please note that we do not offer any warranty for commercial use. We offer an extended warranty for some Leica products, provided you register for a Leica Account. Please visit [www.leica-camera.com](http://www.leica-camera.com) for more details.

### LEICA WARRANTY SCOPE

During the warranty period, complaints based on manufacturing and material defects will be remedied free of charge, at LEICA's discretion, by way of repair, replacement of defective parts, or exchange for a similar Leica product in perfect condition. Replaced parts or products become the property of LEICA.

Further claims of any kind and on any legal grounds whatsoever in connection with this Leica Warranty are excluded.

### EXCLUDED FROM THE LEICA WARRANTY

Parts subject to wear and tear (e.g. eyecups, leather coverings, carry straps, armoring, batteries), and parts under mechanical stress are excluded from the Leica Warranty, unless the defect was caused by manufacturing or material defects. That also applies to any exterior damage.

### VOIDED CLAIMS UNDER LEICA WARRANTY

Claims under the warranty are void if the defect in question is due to improper handling; they may also be void if e.g. third-party accessories have been used, the Leica product has not been opened professionally or has not been repaired professionally. Claims for warranty services shall similarly be void if the serial number is unrecognizable.

### CLAIMS UNDER THE LEICA WARRANTY

We require a copy of the proof of purchase of your Leica product from a LEICA-authorized dealer ("Authorized Leica Dealer") before we can accept any claim under the warranty. The purchase receipt must show the date of purchase, the Leica product with its article number and serial number, and details about the Authorized Leica Dealer. We reserve the right to request the original receipt. Alternatively, you may send us a copy of the warranty card; please note that the Warranty Card must be filled out correctly, and the product must have been purchased from an Authorized Leica Dealer.

Please send your Leica product with a copy of your purchase receipt or the Warranty Card alongside a description of the issue.

Leica Camera AG, Customer Care, Am Leitz-Park 5, 35578 Wetzlar, Germany

Email: [customer.care@leica-camera.com](mailto:customer.care@leica-camera.com)

Phone: +49(0)6441 2080-189

or to an Authorized Leica Dealer.



Leica Product Image	Warranty Term
all products	2 years

**Leica SL3 comes with splash water and dust protection.**

The camera was tested under controlled laboratory conditions and is classed as IP54 in accordance with DIN EN 60529. Please note: The splash water and dust protection coating is not permanent and will diminish over time. Please read the section on “Care/Storage” for detailed instructions on how to clean and dry the camera. The warranty does not cover liquid damage. Any attempt to open the camera casing by an unauthorized retailer or service partner will cause an immediate expiration of the splash water and dust warranty.



# TABLE OF CONTENTS

FOREWORD.....	2
SCOPE OF DELIVERY .....	2
REPLACEMENT PARTS / ACCESSORIES .....	3
LEGAL INFORMATION.....	4
SAFETY REMARKS .....	8
GENERAL INFORMATION .....	12
WARRANTY TERMS LEICA CAMERA AG .....	16
TABLE OF CONTENTS .....	18
PART DESIGNATIONS .....	24
CONNECTOR BLOCK .....	26
DISPLAYS .....	28
PHOTO.....	28
VIDEO/CINE .....	30
DISPLAYS IN THE TOP DISPLAY .....	32
PREPARATION .....	34
ATTACHING THE CARRY STRAP.....	34
PREPARING THE CHARGER.....	34
CHARGING THE BATTERY.....	35
CHARGING VIA USB .....	36
INSERTING/REMOVING THE BATTERY.....	36
INSERTING/REMOVING THE MEMORY CARD .....	38
LENSES .....	40
COMPATIBLE LENSES.....	40
CHANGING THE LENS .....	42
DIOPTER SETTINGS.....	45
MULTIFUNCTION HANDGRIP HG-SCL7 .....	46

CAMERA OPERATION .....	52
CONTROL ELEMENTS .....	52
MAIN SWITCH .....	52
MAIN SWITCH LED.....	53
SHUTTER BUTTON.....	54
LEFT DIAL .....	55
RIGHT DIAL.....	55
THUMBWHEEL .....	56
JOYSTICK .....	56
PLAY BUTTON/MENU BUTTON .....	57
FUNCTION BUTTONS .....	58
LCD PANEL (TOUCH SCREEN).....	59
TOP DISPLAY.....	60
MENU CONTROL.....	60
CONTROL ELEMENTS.....	60
MENU SECTIONS .....	61
SETTINGS IN PHOTO AND VIDEO MODE .....	62
SWITCHING MENU SECTIONS .....	63
CONTROL CENTER.....	64
CUSTOMIZING THE CONTROL CENTER.....	64
MAIN MENU .....	66
MENU NAVIGATION .....	67
SUBMENU .....	69
KEYBOARD/NUMBER PAD.....	69
MENU BAR.....	70
SCALE MENU .....	70
DATE/TIME MENU.....	71
COMBI MENU (AF PROFILES).....	71
COMBI MENU (IMAGE PROPERTIES).....	72
USER-DEFINED OPERATION .....	74
DIRECT ACCESS TO MENU FUNCTIONS.....	74
CHANGING AN ASSIGNMENT.....	74
ACCESSING THE ASSIGNED MENU FUNCTION.....	74
DIAL ASSIGNMENTS.....	75

WHEN USING AF LENSES.....	76	<b>FILE FORMAT</b> .....	<b>91</b>
WHEN USING MF LENSES.....	77	<b>RESOLUTION</b> .....	<b>92</b>
ROTATION DIRECTION OF THE DIALS.....	77	DNG RESOLUTION.....	92
JOYSTICK FUNCTIONS .....	78	JPG RESOLUTION.....	93
LOCKING THE OPERATING ELEMENTS.....	78	<b>ASPECT RATIO</b> .....	<b>94</b>
USER PROFILES .....	79	<b>IMAGE PROPERTIES</b> .....	<b>94</b>
<b>CAMERA BASIC SETTINGS</b> .....	<b>82</b>	<b>FILM STYLE</b> .....	<b>95</b>
<b>MENU LANGUAGE</b> .....	<b>82</b>	COLOR PROFILE.....	96
<b>DATE/TIME</b> .....	<b>82</b>	MONOCHROME PROFILE.....	96
<b>DISTANCE UNIT</b> .....	<b>83</b>	CUSTOMIZING PHOTO PROFILES .....	97
<b>POWER SAVE MODE (STANDBY MODE)</b> .....	<b>84</b>	<b>LEICA LOOKS</b> .....	<b>97</b>
<b>LCD PANEL/VIEWFINDER SETTINGS</b> .....	<b>84</b>	<b>AUTOMATIC OPTIMIZATION</b> .....	<b>98</b>
LCD PANEL/EVF USE.....	85	<b>NOISE REDUCTION</b> .....	<b>98</b>
EYE SENSOR SENSITIVITY.....	85	NOISE REDUCTION FUNCTION FOR LONG-TERM EXPOSURE.....	98
<b>BRIGHTNESS</b> .....	<b>86</b>	NOISE REDUCTION IN JPG IMAGES .....	99
LCD PANEL.....	86	<b>IMAGE STABILIZATION</b> .....	<b>99</b>
EVF.....	86	SETTING THE STABILIZATION DIRECTION .....	100
<b>COLOR RENDERING</b> .....	<b>86</b>	<b>DARK AREA OPTIMIZATION (IDR)</b> .....	<b>101</b>
LCD PANEL.....	86	DYNAMIC RANGE.....	101
EVF.....	86	IDR FUNCTION .....	101
<b>AUTOMATIC LCD PANEL AND EVF SHUTDOWN</b> .....	<b>87</b>	<b>DATA MANAGEMENT</b> .....	<b>102</b>
<b>EVF FRAME RATE</b> .....	<b>87</b>	<b>STORAGE OPTIONS</b> .....	<b>102</b>
<b>AUTOMATIC ROTATION OF THE INFO BAR</b> .....	<b>87</b>	<b>FORMATTING A MEMORY CARD</b> .....	<b>103</b>
<b>ACOUSTIC SIGNALS</b> .....	<b>88</b>	DATA STRUCTURE.....	104
<b>VOLUME</b> .....	<b>88</b>	EDIT FILE NAMES.....	105
<b>ACOUSTIC SIGNALS</b> .....	<b>88</b>	CREATING A NEW FOLDER .....	106
<b>ELECTRONIC SHUTTER SOUND</b> .....	<b>88</b>	ADDING COPYRIGHT INFORMATION .....	106
<b>AUTOFOCUS CONFIRMATION</b> .....	<b>88</b>	LOGGING THE SHOOTING LOCATION.....	107
<b>SILENT PHOTOGRAPHY</b> .....	<b>88</b>	DATA TRANSFER .....	108
<b>&lt;&lt;&lt; PHOTO MODE &gt;&gt;&gt;</b> .....	<b>90</b>	<b>PRACTICAL DEFAULT SETTINGS</b> .....	<b>110</b>
<b>STILL IMAGE SETTINGS</b> .....	<b>90</b>	<b>TOUCH AF</b> .....	<b>110</b>
<b>SENSOR FORMAT</b> .....	<b>90</b>	TOUCH AF + SHUTTER BUTTON.....	111
		TOUCH AF IN EVF MODE.....	111

<b>PERSONALIZED LENS SETTINGS</b> .....	<b>112</b>	<b>AF SETTINGS</b> .....	<b>127</b>
<b>EV INCREMENT</b> .....	<b>112</b>	AF PROFILES .....	127
<b>AUXILIARY DISPLAYS</b> .....	<b>113</b>	PRE FOCUS .....	129
<b>INFO PROFILES</b> .....	<b>113</b>	<b>FOCUS LIMIT</b> .....	<b>130</b>
CHANGING THE INFO PROFILES .....	114	<b>AF QUICK SETTING</b> .....	<b>130</b>
DEACTIVATING INDIVIDUAL INFO PROFILES .....	114	ACCESSING AF QUICK SETTING .....	130
CUSTOMIZING THE INFO PROFILES .....	115	ADJUSTING THE AF FRAME SIZE .....	131
<b>SHOW AVAILABLE</b> .....	<b>115</b>	CHANGING THE AF METERING METHOD .....	131
INFO BARS .....	115	<b>MF ASSIST FUNCTIONS</b> .....	<b>131</b>
GRID LINES .....	116	ENLARGEMENT IN AF MODE .....	131
CLIPPING .....	116	AF ASSIST LAMP .....	132
FOCUS PEAKING .....	117	ACOUSTIC AF CONFIRMATION .....	132
LEVEL GAUGE .....	118	<b>SHIFTING THE AF FRAME</b> .....	<b>133</b>
HISTOGRAM .....	119	<b>MANUAL FOCUSING (MF)</b> .....	<b>133</b>
<b>TEMPORARY ACTIVATION/DEACTIVATION OF INDIVIDUAL FUNCTIONS</b> .....	<b>120</b>	<b>MF ASSIST FUNCTIONS</b> .....	<b>134</b>
<b>ENHANCED LIVE VIEW</b> .....	<b>120</b>	FOCUS PEAKING .....	134
<b>MF ASSIST FUNCTIONS</b> .....	<b>121</b>	ENLARGEMENT IN MF MODE .....	134
AF ASSIST LAMP .....	121	DISTANCE DISPLAY .....	136
ACOUSTIC AF CONFIRMATION .....	121	USING AUTOFOCUS IN MF MODE .....	137
<b>PHOTOGRAPHY</b> .....	<b>122</b>	<b>ISO SENSITIVITY</b> .....	<b>137</b>
<b>DRIVE MODE</b> .....	<b>122</b>	FIXED ISO VALUES .....	137
<b>FOCUSING</b> .....	<b>123</b>	<b>AUTOMATIC SETTING</b> .....	<b>138</b>
AF PHOTOGRAPHY .....	123	LIMITING SETTING RANGES .....	139
<b>AUTOFOCUS MODES</b> .....	<b>123</b>	<b>DYNAMIC ISO SETTING</b> .....	<b>140</b>
INTELLIGENT AF (iAF) .....	123	<b>FLOATING ISO</b> .....	<b>140</b>
AFs (single) .....	123	<b>WHITE BALANCE</b> .....	<b>141</b>
AFc (continuous) .....	123	<b>AUTOMATIC CONTROL/FIXED SETTINGS</b> .....	<b>141</b>
<b>AUTOFOCUS METERING METHODS</b> .....	<b>124</b>	<b>MANUAL SETTING VIA METERING</b> .....	<b>142</b>
MULTI-FIELD METERING .....	124	GRAY CARD (PIPETTE) .....	142
SPOT/FIELD METERING .....	124	GRAY CARD .....	143
ZONE .....	125	<b>DIRECT SETTING OF THE COLOR TEMPERATURE</b> .....	<b>143</b>
TRACKING .....	125	<b>EXPOSURE</b> .....	<b>144</b>
PERSON DETECTION (FACE DETECTION) .....	126	<b>SHUTTER TYPE</b> .....	<b>145</b>

<b>EXPOSURE MODES</b> .....	147	<b>FLASH EXPOSURE METERING (TTL METERING)</b> .....	172
SELECTING A MODE.....	148	<b>SETTINGS ON THE FLASH UNIT</b> .....	173
<b>FULLY AUTOMATIC EXPOSURE SETTING – P</b> .....	149	<b>FLASH MODES</b> .....	173
PROGRAM AE MODE – P.....	149	AUTOMATIC FLASH ACTIVATION.....	173
CHANGING THE PRESET SHUTTER SPEED AND APERTURE COMBINATIONS (SHIFT)...	150	MANUAL FLASH ACTIVATION.....	173
<b>SEMI-AUTOMATIC EXPOSURE SETTING – A/S</b> .....	150	AUTOMATIC FLASH ACTIVATION AT SLOWER SHUTTER SPEEDS (LONG-TERM SYNCHRONIZATION).....	174
APERTURE-PRIORITY MODE- A.....	150	<b>FLASH CONTROL</b> .....	174
SHUTTER-PRIORITY MODE – S.....	151	SYNC POINT.....	174
<b>MANUAL EXPOSURE SETTING – M</b> .....	151	<b>FLASH RANGE</b> .....	175
<b>LONG-TERM EXPOSURE</b> .....	152	<b>FLASH EXPOSURE COMPENSATION</b> .....	176
FIXED SHUTTER SPEEDS.....	152	<b>REVIEW MODE</b> .....	178
B FUNCTION.....	153	<b>CONTROL ELEMENTS IN REVIEW MODE</b> .....	178
NOISE REDUCTION.....	154	DIRECT ACCESS IN PLAYBACK MODE.....	179
<b>EXPOSURE CONTROL</b> .....	155	CONTROL ELEMENTS ON THE LCD PANEL.....	179
EXPOSURE PREVIEW.....	155	<b>STARTING/EXITING REVIEW MODE</b> .....	180
EXPOSURE LOCK.....	155	<b>SELECTING/SCROLLING THROUGH IMAGES</b> .....	181
EXPOSURE COMPENSATION.....	158	<b>STORAGE LOCATIONS</b> .....	182
DEPTH OF FIELD CHECK.....	159	<b>INFO DISPLAYS IN REVIEW MODE</b> .....	183
<b>SHOOTING MODES</b> .....	160	<b>PICTURE SERIES REVIEW</b> .....	184
CONTINUOUS SHOOTING.....	160	PAUSE PLAYBACK.....	184
INTERVAL SHOOTING.....	161	RESUMING PLAYBACK.....	184
EXPOSURE BRACKETING.....	163	SAVE AS A VIDEO.....	185
SELF-TIMER.....	165	<b>CROPPED SECTION ZOOM</b> .....	186
<b>SPECIAL SHOOTING MODES</b> .....	166	<b>DISPLAYING MULTIPLE IMAGES AT ONCE</b> .....	187
PERSPECTIVE CONTROL.....	166	<b>TAGGING/RATING OF IMAGES</b> .....	189
ACTIVE PERSPECTIVE CONTROL.....	167	<b>DELETING IMAGES</b> .....	189
DETECTED PERSPECTIVE IN LIVE VIEW MODE.....	167	DELETING INDIVIDUAL IMAGES.....	190
CORRECTED PERSPECTIVE IN REVIEW MODE.....	167	DELETING MULTIPLE IMAGES.....	191
JPG FORMAT IMAGES.....	168	DELETING ALL UNRATED IMAGES.....	192
DNG FORMAT IMAGES.....	168	DELETING PICTURE SERIES.....	192
PERSPECTIVE CONTROL IN ADOBE LIGHTROOM® AND ADOBE PHOTOSHOP®.....	168	<b>PREVIEW OF LATEST IMAGE</b> .....	193
IMAGE OVERLAY.....	169		
<b>FLASH PHOTOGRAPHY</b> .....	171		
COMPATIBLE FLASH UNITS.....	171		

<b>VIDEO SETTINGS</b> .....	194
<b>SENSOR FORMAT</b> .....	194
<b>FILE FORMAT</b> .....	194
<b>VIDEO FORMAT</b> .....	195
SETTING THE VIDEO FORMAT .....	195
<b>VIDEO STYLE</b> .....	196
IMAGE PROPERTIES.....	196
VIDEO PROFILES.....	197
COLOR PROFILE.....	197
MONOCHROME PROFILE.....	197
CUSTOMIZING VIDEO PROFILES.....	197
<b>AUDIO SETTINGS</b> .....	198
MICROPHONE .....	198
WIND NOISE REDUCTION .....	199
<b>TIMECODE</b> .....	200
TIMECODE MODE.....	200
START TIME .....	201
TC SYNCHRONIZATION .....	201
<b>VIDEO GAMMA</b> .....	202
HLG SETTINGS.....	202
L-LOG SETTINGS.....	203
SETUP/MANAGEMENT OF LUT PROFILES.....	203
USING LUT PROFILES.....	205
<b>AUTOMATIC OPTIMIZATION</b> .....	207
VIDEO STABILIZATION.....	207
DARK AREA OPTIMIZATION (IDR).....	207
DYNAMIC RANGE.....	207
IDR FUNCTION .....	208
<b>DATA MANAGEMENT</b> .....	209
SEGMENTED RECORDING.....	209
FORMATTING A MEMORY CARD .....	209

DATA STRUCTURE.....	210
EDIT FILE NAMES.....	211
CREATING A NEW FOLDER .....	212
ADDING COPYRIGHT INFORMATION .....	212
LOGGING THE SHOOTING LOCATION.....	213
DATA TRANSFER .....	214
<b>PRACTICAL DEFAULT SETTINGS</b> .....	216
<b>TOUCH AF</b> .....	216
TOUCH AF + SHUTTER BUTTON.....	217
TOUCH AF IN EVF MODE.....	217
<b>PERSONALIZED LENS SETTINGS</b> .....	218
<b>EV INCREMENT</b> .....	218
<b>AUDIO OUTPUT</b> .....	219
SETTING THE OUTPUT LEVEL.....	219
HDMI OUTPUT WITH/WITHOUT SOUND.....	219
<b>AUXILIARY DISPLAYS</b> .....	220
<b>INFO PROFILES</b> .....	220
CHANGING THE INFO PROFILES.....	221
DEACTIVATING INDIVIDUAL INFO PROFILES.....	221
CUSTOMIZING THE INFO PROFILES .....	222
<b>SHOW AVAILABLE</b> .....	222
INFO BARS .....	222
GRID LINES .....	223
ZEBRA.....	223
FOCUS PEAKING.....	224
LEVEL GAUGE .....	225
HISTOGRAM .....	226
<b>WAVEFORM MONITOR (WFM)</b> .....	227
ADJUSTING VISUALIZATION .....	228
ASPECT RATIO DISPLAY.....	229
FRAMELINE .....	229
<b>VIDEO ASSIST FUNCTIONS</b> .....	230
REFERENCE VALUES .....	230

COLOR BAR.....	230	<b>PREPARATION.....</b>	<b>251</b>
<b>TEST SOUND.....</b>	<b>231</b>	CONFIGURING A FOCUS POSITION.....	251
APPLICATION.....	231	CHANGING THE FOCUS POSITION.....	252
<b>REC FRAME.....</b>	<b>232</b>	<b>USE.....</b>	<b>253</b>
<b>MF ASSIST FUNCTIONS.....</b>	<b>233</b>	ACCESS AS NEEDED.....	253
AF ASSIST LAMP.....	233	AUTOMATIC SEQUENCE.....	254
<b>RECORDING VIDEO.....</b>	<b>234</b>	<b>OTHER SETTINGS.....</b>	<b>255</b>
<b>VIDEO MODE AND CINE MODE.....</b>	<b>234</b>	SPEED.....	255
<b>START/EXIT VIDEO MODE.....</b>	<b>235</b>	SUBSEQUENT FOCUS MODE.....	255
<b>START/END VIDEO RECORDING.....</b>	<b>236</b>	<b>ISO SENSITIVITY.....</b>	<b>256</b>
DISPLAY AND OPERATION VIA USB-PTP USING EXTERNAL ACCESSORY (LIKE GIMBALS).....	237	FIXED ISO VALUES.....	256
<b>FOCUSING.....</b>	<b>237</b>	AUTOMATIC SETTING.....	257
AUTOFOCUS MODES.....	238	DYNAMIC ISO SETTING.....	259
CONTROLLING THE AUTOFOCUS.....	238	FLOATING ISO.....	259
TOUCH AF.....	238	<b>ASA SENSITIVITY.....</b>	<b>260</b>
SUPPRESSING CONTINUOUS FOCUSING.....	238	<b>WHITE BALANCE.....</b>	<b>261</b>
AUTOFOCUS METERING METHODS.....	239	AUTOMATIC CONTROL/FIXED SETTINGS.....	261
<b>TRACKING.....</b>	<b>240</b>	MANUAL SETTING VIA METERING.....	262
PERSON DETECTION (FACE DETECTION).....	241	GRAY CARD (PIPETTE).....	262
<b>AF SETTINGS.....</b>	<b>242</b>	GRAY CARD.....	263
<b>FOCUS LIMIT.....</b>	<b>243</b>	DIRECT SETTING OF THE COLOR TEMPERATURE.....	263
<b>AF QUICK SETTING.....</b>	<b>244</b>	<b>EXPOSURE.....</b>	<b>264</b>
ADJUSTING THE AF FRAME SIZE.....	244	EXPOSURE MODES.....	266
CHANGING THE AF METERING METHOD.....	244	FULLY AUTOMATIC EXPOSURE SETTING - P.....	267
<b>MF ASSIST FUNCTIONS.....</b>	<b>245</b>	SEMI-AUTOMATIC EXPOSURE SETTING - A/S.....	268
ENLARGEMENT IN AF MODE.....	245	MANUAL EXPOSURE SETTING - M.....	268
<b>SHIFTING THE AF FRAME.....</b>	<b>246</b>	EXPOSURE COMPENSATION.....	269
<b>MANUAL FOCUSING (MF).....</b>	<b>246</b>	<b>PLAYBACK MODE.....</b>	<b>270</b>
<b>MF ASSIST FUNCTIONS.....</b>	<b>247</b>	<b>CONTROL ELEMENTS IN PLAYBACK MODE.....</b>	<b>270</b>
<b>FOLLOW FOCUS.....</b>	<b>249</b>	DIRECT ACCESS IN PLAYBACK MODE.....	271
FUNCTION BEHAVIOR.....	250	CONTROL ELEMENTS ON THE LCD PANEL.....	271
FOLLOW FOCUS MENU.....	250	<b>INITIATE/EXIT PLAYBACK MODE.....</b>	<b>272</b>
		<b>SELECTING/SCROLLING THROUGH IMAGES.....</b>	<b>273</b>

STORAGE LOCATIONS.....	274	AUTOMATIC SENSOR CLEANING.....	303
INFO DISPLAYS IN PLAYBACK MODE.....	275	PIXEL MAPPING.....	304
DISPLAYING MULTIPLE IMAGES AT ONCE.....	276	FAQ.....	306
TAGGING/RATING OF RECORDINGS.....	277	MENU OVERVIEW.....	312
DELETING RECORDINGS.....	278	INDEX.....	322
DELETING INDIVIDUAL RECORDINGS.....	278	TECHNICAL DATA.....	330
DELETING MULTIPLE RECORDINGS.....	279	LEICA CUSTOMER CARE.....	338
DELETING ALL UNRATED IMAGES.....	280	LEICA AKADEMIE.....	339
VIDEO PLAYBACK.....	281		
VIDEO EDITING.....	284		
<<<>>>.....	285		
OTHER FUNCTIONS.....	286		
RESETTING THE CAMERA TO FACTORY SETTINGS.....	286		
FIRMWARE UPDATES.....	287		
EXECUTING A FIRMWARE UPDATE.....	288		
LEICA FOTOS.....	292		
SELECTING A WI-FI BAND.....	292		
CONNECTIVITY (iPhone users).....	293		
FIRST-TIME CONNECTION TO A MOBILE DEVICE.....	293		
CONNECTING WITH PAIRED DEVICES.....	295		
CONNECTIVITY (Android users).....	296		
FIRST-TIME CONNECTION TO A MOBILE DEVICE.....	296		
CONNECTING WITH PAIRED DEVICES.....	297		
CONNECTIVITY MODES.....	298		
PERFORMANCE MODE.....	299		
ECO MODE.....	299		
AIRPLANE MODE.....	299		
EXECUTING A FIRMWARE UPDATE.....	299		
REMOTE CAMERA CONTROL.....	300		
CARE/STORAGE.....	302		



**Definition of the various categories of information found in this manual****Note**

Additional information

**Important**

Failure to comply with instructions may result in damage to the camera, the accessories or the data files

**Attention**

Non-compliance may result in personal injury



# PART DESIGNATIONS

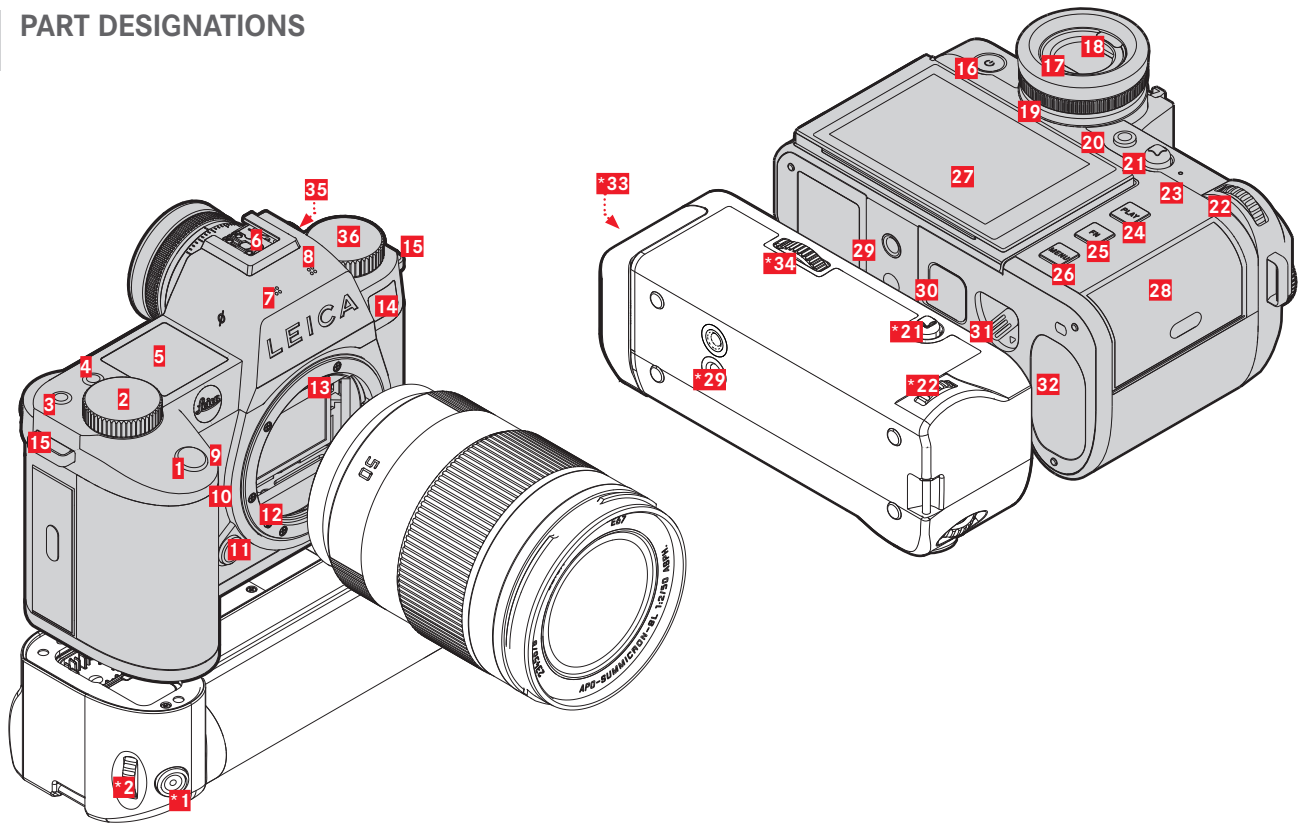

\*Optional accessories: Multifunction handgrip SL, Leica USB-C DC coupler DC-SCL6

## LEICA SL3

- 1** Shutter button
- 2** Right dial
- 3** Function button
- 4** Function button
- 5** Top display
- 6** Accessory shoe
- 7** Microphone
- 8** Speaker
- 9** Function button
- 10** Function button
- 11** Lens release button
- 12** Leica L bayonet
- 13** Contact strip
- 14** Self-timer LED / AF Assist Lamp / Sensor for exposure metering
- 15** Strap lugs
- 16** Main switch
- 17** Viewfinder eyepiece
- 18** Eye sensor
- 19** Diopter setting ring
- 20** FN button\*\*
- 21** Joystick
- 22** Thumbwheel
- 23** Status LED
- 24** **PLAY** button

- 25** FN button\*\*
- 26** **MENU** button
- 27** LCD panel
- 28** Memory card slot
- 29** Tripod thread
- 30** Contact for multifunction handgrip
- 31** Battery release lever
- 32** Battery compartment
- \*33** Handgrip-integrated battery compartment
- \*34** Handgrip lock
- 35** Timecode connection
- 36** Left dial

## MULTIFUNCTION HANDGRIP SL

- \*1** Shutter button
- \*2** Right dial
- \*21** Joystick
- \*22** Thumbwheel
- \*29** Tripod thread
- \*33** Handgrip-integrated battery compartment
- \*34** Handgrip lock



## CONNECTOR BLOCK

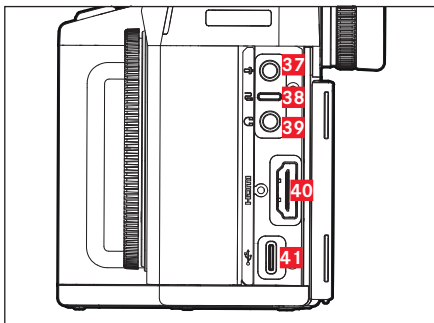

- 37** Microphone
- 38** Remote shutter release
- 39** Headphone
- 40** HDMI
- 41** USB-C

## USB-C DC COUPLER DC-SCL6

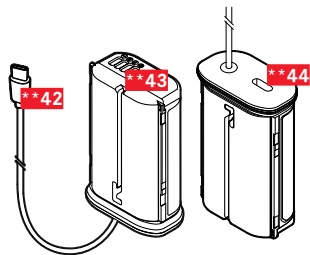

- \*\*42** USB-C cable
- \*\*43** Contacts
- \*\*44** USB-C cable socket (transport protection)

**LENS\***

- 45** Contact strip
- 46** Alignment points for lens replacement
- 47** Focus ring  
poss. zoom ring
- 48** Alignment point for lens hood mounting
- 49** Male bayonet for lens hood
- 50** Internal thread for filters
- 51** Bayonet cover
- 52** Lens cap
- 53** Lens hood

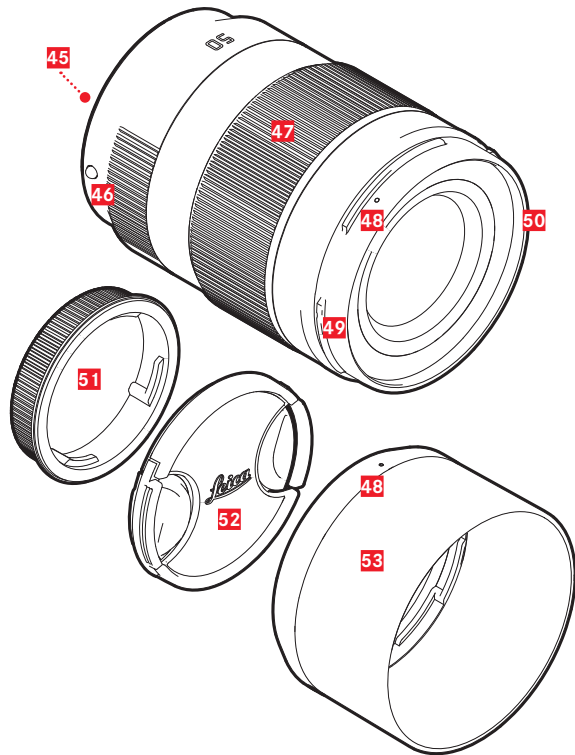

\* Not included in the delivery package. Representative image. Technical designs may vary depending on included features.



## DISPLAYS

The images displayed on the LCD panel and in the viewfinder are identical.

### PHOTO

#### CONTROL CENTER

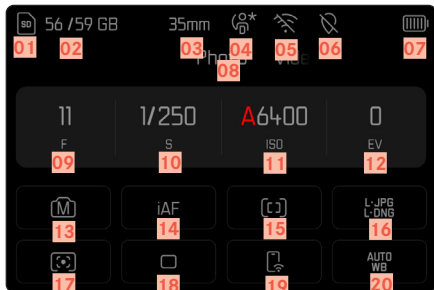

### IN SHOOTING MODE

All displays/values refer to the actual settings.

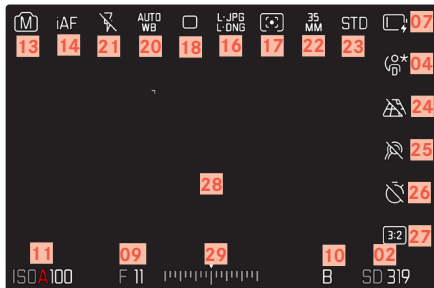

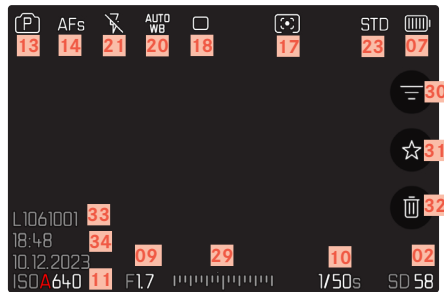

### IN REVIEW MODE

All displays/values refer to the displayed image.

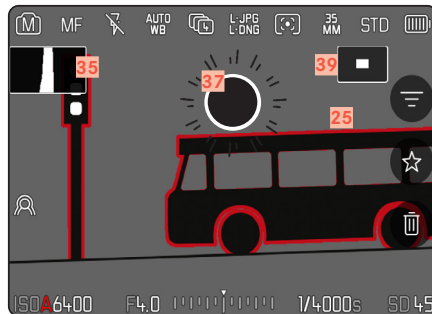

### ACTIVATED Capture Assistants



- 01 Memory card used
- 02 Remaining storage capacity
- 03 Focal length
- 04 User profile
- 05 Wi-Fi/Bluetooth® (Leica FOTOS)
- 06 Geotagging  
Automatic storage of the shooting location (Exif data)
- 07 Battery capacity
- 08 Menu section **PHOTO**
- 09 Aperture value
- 10 Shutter speed
- 11 ISO Sensitivity
- 12 Exposure compensation value
- 13 Exposure mode
- 14 Focus mode
- 15 Autofocus metering method
- 16 File format/compression level/resolution
- 17 Exposure metering method
- 18 Shooting mode (**Drive Mode**)
- 19 Leica FOTOS
- 20 White balance mode
- 21 Flash mode/flash exposure compensation  
(Photo mode only)
- 22 Sensor format
- 23 Color rendering (**Film Style/Leica Look**)
- 24 Perspective Control
- 25 Focus peaking  
(identification of in sharp edges in the object)
- 26 Self-timer
- 27 Aspect ratio
- 28 AF Field
- 29 Exposure compensation scale
- 30 Filter
- 31 Icon for marked picture
- 32 Delete
- 33 File number of the image shown
- 34 Date and time of shot
- 35 Histogram
- 36 Grid lines
- 37 Clipping identification of overexposed subject elements
- 38 Level gauge
- 39  Display of cropped section size and position  
(only visible for enlarged sections)



## VIDEO/CINE

### CONTROL CENTER

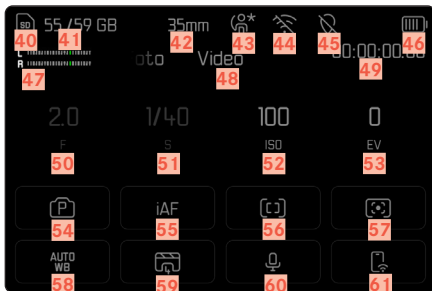

### IN RECORDING MODE

All displays/values refer to the actual settings.

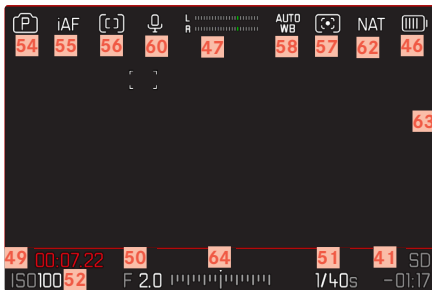

### IN PLAYBACK MODE

All displays/values refer to the displayed image.

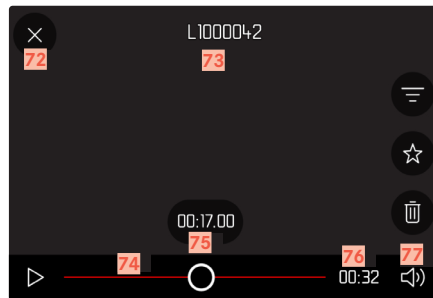
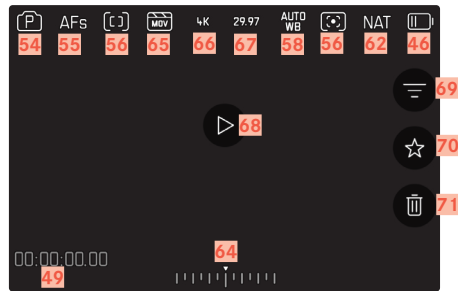



- 40 Memory card used
- 41 Remaining storage capacity
- 42 Focal length
- 43 User profile
- 44 Wi-Fi/Bluetooth® (Leica FOTOS)
- 45 Geotagging  
Automatic storage of the shooting location (Exif data)
- 46 Battery capacity
- 47 Microphone recording level
- 48 Menu sections **VIDEO**
- 49 Timecode counter
- 50 Aperture value
- 51 Shutter speed
- 52 ISO Sensitivity
- 53 Exposure compensation value
- 54 Exposure mode
- 55 Focus mode
- 56 Autofocus metering method
- 57 Exposure metering method
- 58 White balance mode
- 59 Video profile
- 60 Microphone sensitivity (**Microphone Gain**)
- 61 Leica FOTOS
- 62 Color rendering (**Video Style/Leica Look**)
- 63 Indicates for video recording in progress
- 64 Exposure compensation scale
- 65 File format
- 66 Resolution
- 67 Frame rate
- 68 Start playback
- 69 Filter
- 70 Icon for marked video recording
- 71 Delete
- 72 Exiting video playback
- 73 File name of the displayed video recording
- 74 Playback status bar
- 75 Current playback time
- 76 Length of video recording
- 77 Volume bar

## DISPLAYS IN THE TOP DISPLAY

### Home screen



### DEFAULT VIEW

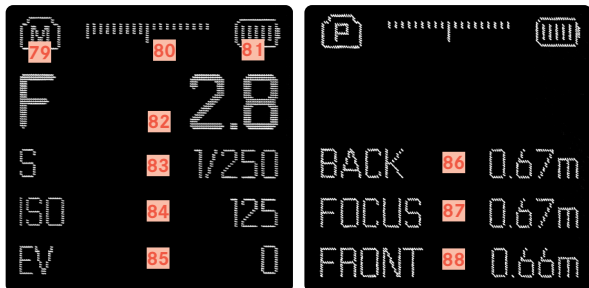





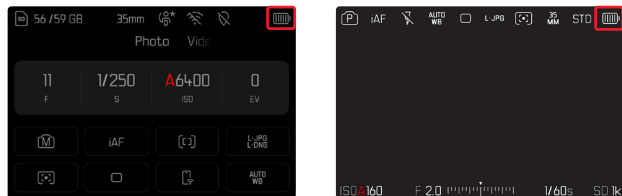

- 78 Camera name
- 79 Operating mode
- 80 Light balance
- 81 Battery capacity
- 82 Aperture value
- 83 Shutter speed  
(Cine: shutter angle)
- 84 ISO Sensitivity  
(Cine: ASA indication)
- 85 Exposure compensation value
- 86 End of focus range
- 87 Current focus range
- 88 Start of focus range

## CHARGE STATUS INDICATOR ON THE LCD PANEL

The charge level of the rechargeable battery is displayed in the Control Center and in the header line at the top right.



Display	Charge status
	Approx. 80 - 100%
	Approx. 60 - 79%
	Approx. 40 - 59%
	Approx. 20 - 39%
	Approx. 1 - 19%
	Approx. 0% The battery needs charging or replacing



## PREPARATION

### ATTACHING THE CARRY STRAP

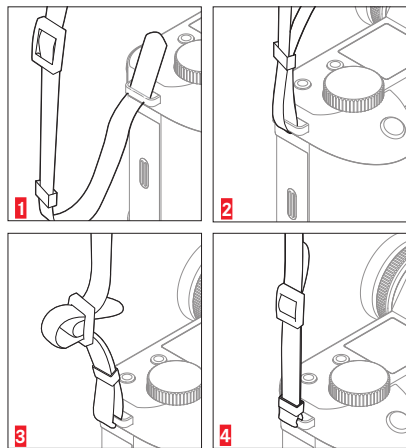

#### Attention

- Once you have attached the carry strap, please make sure that the clips are mounted correctly to prevent the camera from falling.

### PREPARING THE CHARGER (optional accessory)

Use the mains cable with the matching regional plug to connect the charger to mains electricity.

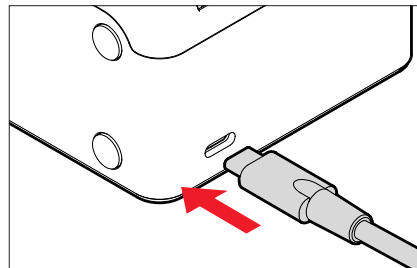

#### Note

- The charger will automatically adapt to local mains voltage.

## CHARGING THE BATTERY

The camera is powered by a lithium-ion battery.

### INSERTING THE BATTERY IN THE CHARGER

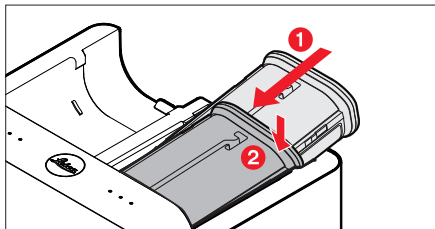

- ▶ Slide the battery into the charger with the groove facing up until the contacts meet
- ▶ Press down on the battery until you can hear and feel it clicking into place
- ▶ Ensure that the battery is fully inserted into the charger

### REMOVING THE BATTERY FROM THE CHARGER

- ▶ Tilt the battery up and lift it out at an angle

## CHARGE STATUS INDICATORS ON THE CHARGER

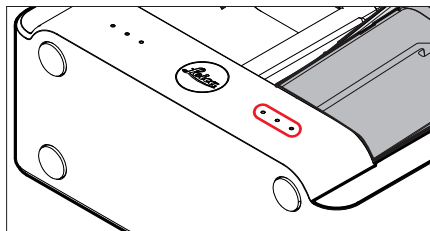

The status LED indicates a correct charging process.

Display	Charge status	Charge time*
●	Battery is charging	
● ●	80%	Approx. 2 h
● ● ●	100%	Approx. 3.5 h

Disconnect the charger from mains electricity when the charging process is complete. There is no risk of overcharging.

\* for a completely discharged battery



## CHARGING VIA USB

The rechargeable battery in the camera can be automatically charged when the camera is connected to a computer or another suitable power source via USB cable.

### Notes

- The SL3 can be charged while it is switched on. This requires a USB PD-capable power supply unit with an output of min. 9 V/3 A (27 W). Where a power supply unit with an output of less than 27 W is used, the camera can only be charged while it is switched off.
- The rechargeable battery in the optional Multifunction Handgrip (HG-SCL7) can also be charged via the camera and power supply unit.
- The charging will start automatically.
- For safety reasons, the battery is only minimally charged on delivery. The battery must be activated with an initial charge before first use.



## INSERTING/REMOVING THE BATTERY

- ▶ Ensure that the camera is switched OFF (see p. 63)

### INSERTION

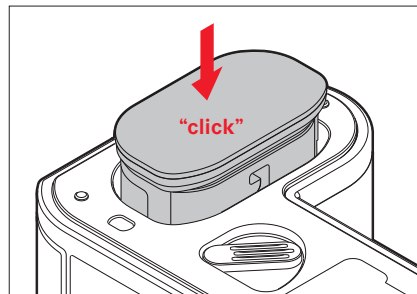

- ▶ Insert the battery into the slot with the groove pointing towards the LCD panel and gently push until you hear and feel it clicking into place

## REMOVAL

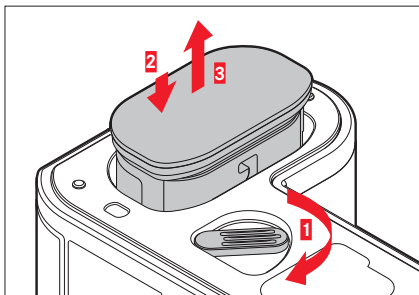

- ▶ Turn the battery release lever
  - Battery is pushing out slightly.
- ▶ Press down on the battery lightly
  - The battery unlocks and pushes out fully.
- ▶ Remove the battery

### Important

- Removing the battery while the camera is switched on may result in the loss of custom settings or damage to the memory card.





## INSERTING/REMOVING THE MEMORY CARD

Leica SL3 offers slots for two memory cards. There are various options for use, see p. 104.

The camera will save exposures to an SD (Secure Digital), SDHC (Secure Digital High Capacity), or SDXC (Secure Digital eXtended Capacity) card, and to a Cfexpress (Compactflash express) Type B.

### Notes

- SD/SDHC/SDXC memory cards are available from various manufacturers in various sizes and with different read/write speeds. Memory cards with high storage capacities and high read/write speeds offer quick storage and rendering.
- The memory card may not be supported (capacity) or will have to be formatted in the camera before first use (see p. 104). The camera will in that case display a relevant message. Please see the section “Technical Data” for information about supported cards.
- Check the memory card for correct alignment if you are having difficulties inserting it into the camera.
- Video shootings require a high write speed.

## OPENING THE COVER OVER THE MEMORY CARD SLOT

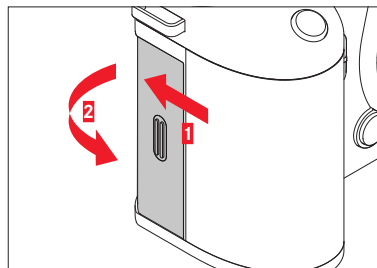

- ▶ Slide the cover as shown in the illustration until you hear a click
  - The cover lifts automatically.

## CLOSING THE COVER OVER THE MEMORY CARD SLOT

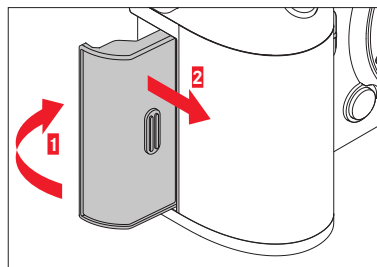

- ▶ Close and hold down the cover
- ▶ Slide the cover as shown in the illustration until it audibly clicks into place



## INSERTION

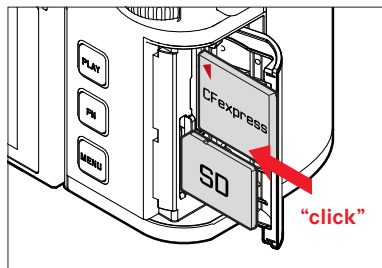

- ▶ Push the memory card into the slot until you hear and feel it clicking into place
  - The beveled corner of the SD card must be at the top left.
  - The ◀ marking on the CFe card must be visible when inserting the card.

## REMOVAL

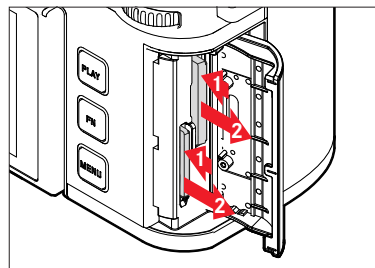

- ▶ Push down on the card until you hear a click
  - The card pushes out slightly.
- ▶ Remove the memory card





## LENSES

### COMPATIBLE LENSES

Sophisticated optical systems guarantee the excellent imaging performance of the SL lenses. In the design phase for the optics, a homogeneous performance across all focal lengths, aperture and focus settings is a high priority. That is how SL lenses can be used for optimally creative results in any situation.

Leica M and R lenses can also be used in conjunction with Leica M/R L adapters.

### L-MOUNT LENSES

In addition to Leica SL lenses, the Leica SL3 can also accommodate Leica TL lenses with full functionality via the L bayonet. The camera will automatically switch to the APS-C format when a TL lens is attached. A variety of compatible lenses from manufacturers of the L-Mount Alliance are also available.

### EXPOSURE METERING AND EXPOSURE CONTROL USING VARIO LENSES

Some Leica TL, SL Vario, and L-mount lenses have a variable light intensity, which means that the effective lens aperture varies depends on the configured focal length. Make sure to set the desired focal length before storing the meter value or changing the shutter speed/aperture combination to prevent incorrect exposure. Please read the sections on “Exposure” starting on page 146 for more information. Make sure that the aperture setting on the flash unit matches the camera aperture if you are using a non-system compatible flash unit.



## LEICA M AND R LENSES

Leica M and R lenses can be attached via Leica M or R L adapters. There are lens profiles stored in the camera, which allow the following functions:

- The flash exposure and flash reflector controls utilize the stored lens data (see “Compatible flash units”).
- As a rule, the correct focal length for lenses that are not detected automatically should always be set manually.
- The lens data is furthermore written to the Exif data of the recordings, provided the lens is relevantly encoded. The focal length of the lens is additionally displayed when rendering the extended image data.

The camera will automatically select the appropriate lens type settings if the Leica M lens used comes with 6-bit encoding, or the Leica R lens has an ROM contact strip. You will have to enter the lens type manually if the lenses do not have that feature.

### Using automatic detection

- ▶ Select **Camera Settings** in the main menu
- ▶ Select **Lens Profiles**
- ▶ Activate automatic lens detection (**Auto**) or deactivate the feature (**Off**)

### Setting the lens type manually

- ▶ Select **Camera Settings** in the main menu
- ▶ Select **Lens Profiles**
- ▶ Select **M-Lenses** or **R-Lenses**

## Sorting the lens type lists

- ▶ Select **Camera Settings** in the main menu
- ▶ Select **Lens Profiles**
- ▶ Select **M-Lenses** or **R-Lenses**
- ▶ Select **Edit List of M-Lenses** or **Edit List of R-Lenses**
- ▶ Activate (**On**) or deactivate (**Off**) the lens types you will be using



## CHANGING THE LENS

### Important

- Make sure to always have a lens or the camera bayonet cover attached to prevent dust or other foreign bodies penetrating the camera.
- That is why you should always replace lenses quickly and in a dust-free environment.

### L-MOUNT LENSES

#### ATTACHING THE LENS

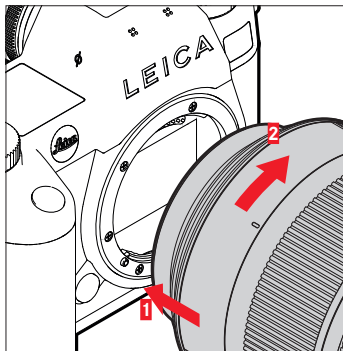

- ▶ Ensure that the camera is switched OFF (see p. 63)
- ▶ Hold the lens by the fixed ring
- ▶ Position the alignment points on the lens opposite the release button on the camera housing
- ▶ Attach the lens in this position
- ▶ Turn the lens clockwise until you hear and feel it click into place

#### DETACHING THE LENS

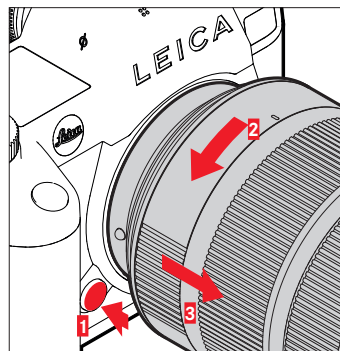

- ▶ Ensure that the camera is switched OFF
- ▶ Hold the lens by the fixed ring
- ▶ Press and hold the release button on the camera housing
- ▶ Turn the lens counter-clockwise until the alignment point is opposite the release button
- ▶ Detach the lens

## OTHER LENSES

### (e.g. Leica M lenses)

Other lenses can be used by inserting an adapter for L bayonets (e.g. Leica-M adapter L).

### ATTACHING THE ADAPTER

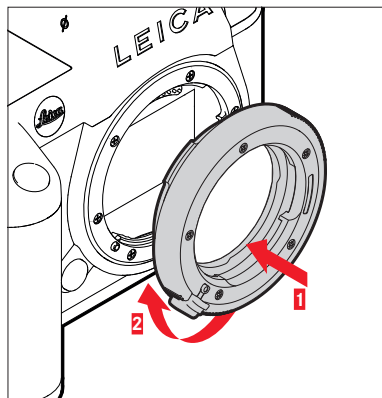

- ▶ Ensure that the camera is switched OFF (see p. 63)
- ▶ Position the alignment point on the adapter opposite the alignment point on the camera housing
- ▶ Attach the lens in this position
- ▶ Turn the adapter clockwise until you hear and feel it click into place
- ▶ Attach the lens immediately

### DETACHING THE ADAPTER

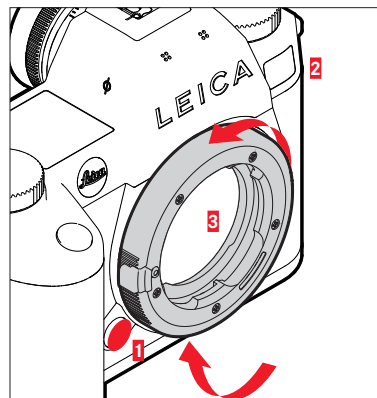

- ▶ Ensure that the camera is switched OFF
- ▶ Detach the lens
- ▶ Press and hold the release button on the camera housing
- ▶ Turn the adapter counter-clockwise until the alignment point is opposite the release button
- ▶ Detach the adapter





## ATTACHING THE LENS TO THE ADAPTER

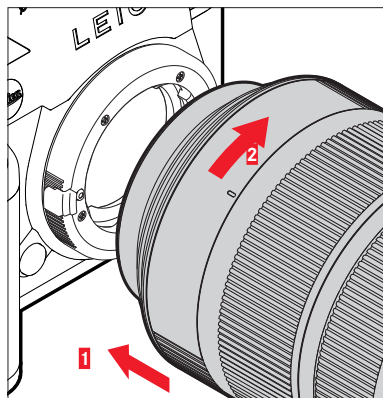

- ▶ Ensure that the camera is switched OFF (see p. 63)
- ▶ Hold the lens by the fixed ring
- ▶ Position the alignment point on the lens opposite the alignment point on the adapter
- ▶ Attach the lens in this position
- ▶ Turn the lens clockwise until you hear and feel it click into place

## DETACHING THE LENS FROM THE ADAPTER

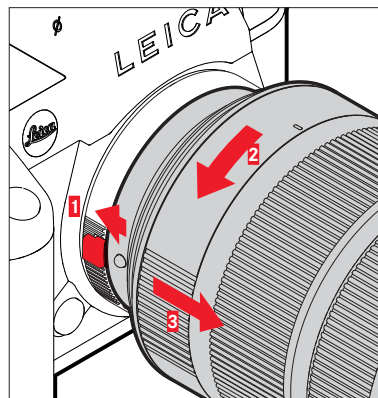

- ▶ Ensure that the camera is switched OFF
- ▶ Hold the lens by the fixed ring
- ▶ Press and hold the release button on the adapter
- ▶ Turn the lens counter-clockwise until its alignment point is opposite the release button
- ▶ Detach the lens

## DIOPTER SETTINGS

The viewfinder has a diopter setting function with a range between -4 and +2 diopter to allow glasses wearers the use of the camera without eyeglasses (diopter compensation).

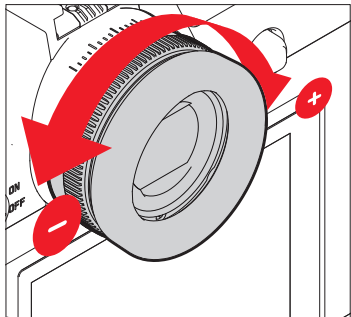

- ▶ Look through the viewfinder
- ▶ Aiming at and focusing on an object
- ▶ Turn the diopter setting ring until you see the image in the viewfinder and the displays in perfect focus

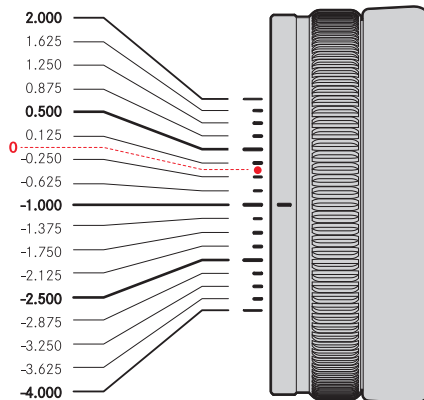



## MULTIFUNCTION HANDGRIP HG-SCL7 (optional accessory)

The Multifunction Handgrip SL is an optional accessory and comes with additional operating elements positioned to specifically facilitate vertical format photography (shutter button, joystick, thumb-wheel, and right dial). It ensures a secure grip for single-handed shooting. It also offers space for a second rechargeable battery.

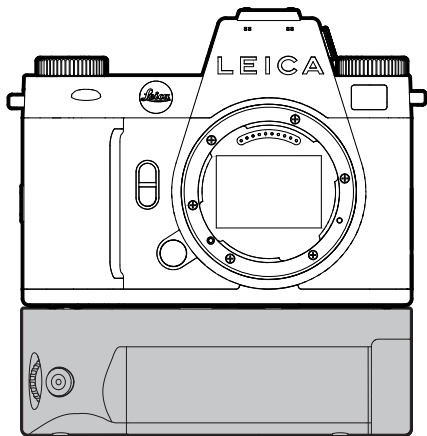

## PHOTOGRAPHY WITH THE HANDGRIP

The operating elements of the handgrip are positioned in such a way as to be in easy reach when using the camera for portrait photography.

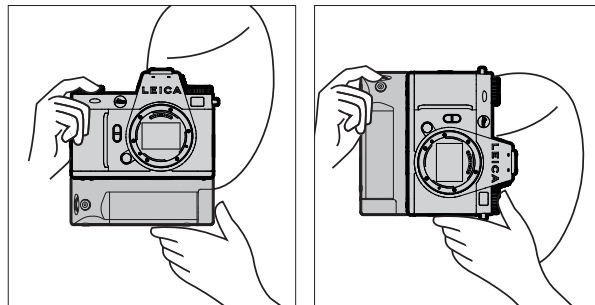



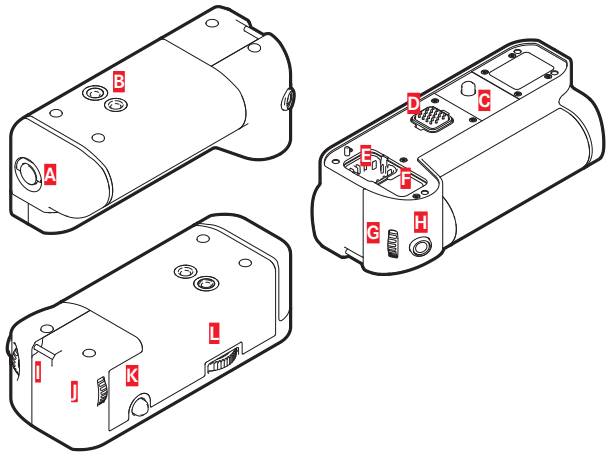

- A** Locking toggle
- B** Tripod thread
- C** Attachment screw
- D** Interface with the camera
- E** Storage compartment for the contact cover of the handgrip
- F** Storage compartment for the contact cover of the camera
- G** Right dial
- H** Shutter button
- I** Strap lug
- J** Thumbwheel
- K** Joystick
- L** Handgrip lock

## ATTACHING THE HANDGRIP

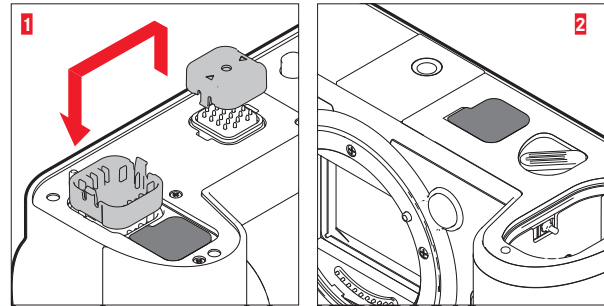

- ▶ Squeeze the contact cover of the handgrip on the two sides marked with triangles and lift it off
- ▶ Store the contact cover in its designated compartment in the handgrip
- ▶ Remove the contact cover in the base of the camera housing
- ▶ Store the contact cover in its designated compartment in the handgrip

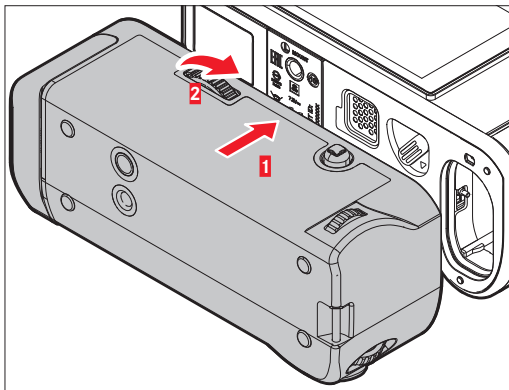

- ▶ Align the handgrip with the base of the camera
  - Make sure not to damage the contacts.
- ▶ Turn the handgrip lock to the right and hand tighten

#### Important

- Make sure to check regularly whether the connection is still tight when using the camera with the handgrip attached and re-tighten it as needed.

#### DETACHING THE HANDGRIP

- ▶ Turn the handgrip lock to the left to unlock the connection
  - Make sure to hold the camera and the handgrip securely while doing so.
- ▶ Replace both cover caps over the connections

#### Important

- Make sure that the contact covers are securely in place on the camera and on the handgrip whenever the handgrip is not attached to the camera. The highly sensitive contacts could otherwise easily be damaged.

## MOUNTING THE WRIST LOOP/CARRY STRAP ON THE MULTIFUNCTION HANDGRIP

The high quality wrist loop is available as an optional ergonomic accessory for the handgrip to ensure more stability for the camera. The hand loop is recommended in particular for landscape photography.

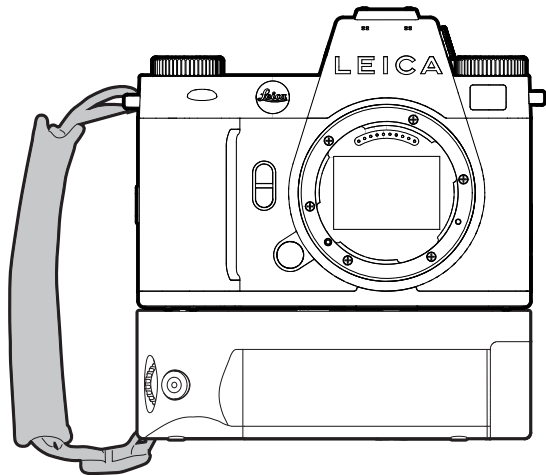

When using the handgrip for portrait photography for extended periods of time, we recommend attaching the carry strap on the strap lug of the camera on the right-hand side and on the strap lug of the handgrip. This will always maintain the camera in the correct position. See p. 36 for instructions on how to attach the carry strap.

## CHANGING THE BATTERY

The multifunction handgrip offers space for a second rechargeable battery. This will significantly increase operating time.

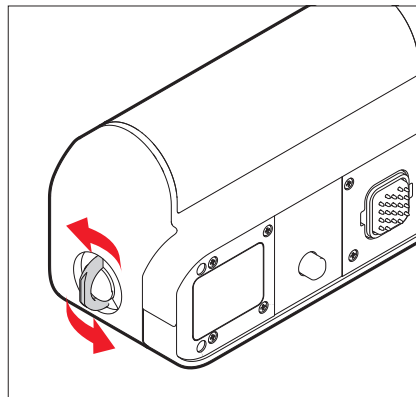

- ▶ Click up the locking toggle
- ▶ Turn the locking toggle in anti-clockwise direction
  - The battery cover lifts automatically.

## REMOVING THE BATTERY

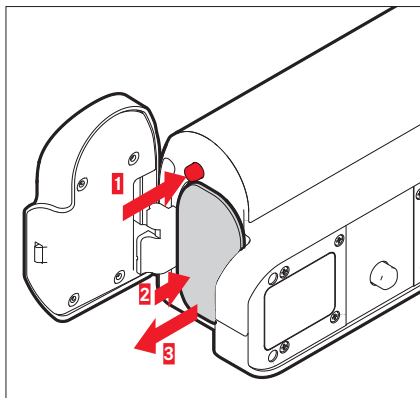

- ▶ Push down the ejector pin
  - Battery is pushing out slightly.
- ▶ Press down on the battery lightly
  - The battery unlocks and pushes out fully.
- ▶ Remove the battery

### Note

- The battery inside the handgrip can be recharged via USB-C.
- The battery inside the handgrip will be utilized first. Once depleted, the camera will automatically switch from the battery inside the handgrip to the battery inside the camera.
- Removing the battery while the camera is switched on may result in the loss of custom settings or damage to the memory card.

## INSERTING THE BATTERY

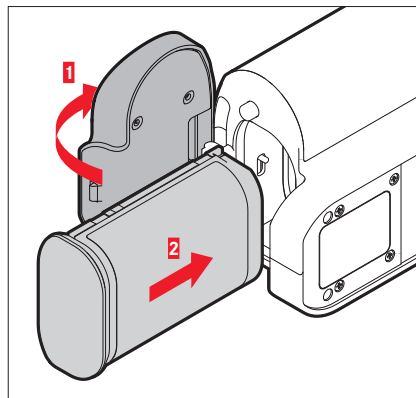

- ▶ Insert the battery into the slot with the groove pointing towards until you hear and feel it clicking into place

## CLOSE THE BATTERY COMPARTMENT

- ▶ Close the cover over the battery compartment
  - It will click to signify it is locked.
- ▶ Click down the locking toggle

### Note

- The camera must have a battery with at least minimal charge inserted to utilize a rechargeable battery in the handgrip.





## CAMERA OPERATION

### CONTROL ELEMENTS

#### MAIN SWITCH

The main switch switches the camera on, off, or to stand-by.

#### SWITCHING THE CAMERA ON/OFF

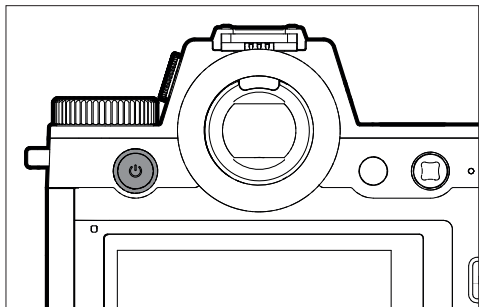

Status	Button press	Function
Off	Press and release (>0.1 s)	Switching on
On	Press and release (>0.1 s)	Standby mode
On	Press and hold (>1.5 s)	Switching off
Standby mode	Press and hold (>1.5 s)	Switching off
Standby mode	Press and release (>0.1 s)	Switching on

#### Notes

- Once switched on, the camera will be ready to use after approx. 1 s.
- The main switch LED lights up briefly and the displays appear in the viewfinder.
- The function **Auto Power Off** (see p. 86) deactivates the camera automatically if no operation occurs within a preset time. Use the main switch to deactivate the camera if this function is **Off** to prevent inadvertent exposures and battery discharge when the camera is not in use. The same applies for Standby mode.



## MAIN SWITCH LED

The main switch LED indicates various operating states. It will light within 1 s of the main switch being pressed. The LED can be set to automatically dim depending on ambient brightness. The brightness of the LED is reduced automatically during camera operation.

### Adjusting the setting

Factory setting: **Low**

- ▶ Select **Camera Settings** in the main menu
- ▶ Select **Power Saving**
- ▶ Select **Power Button LED**
- ▶ Select **Settings**
- ▶ **Low** (approx. 2% brightness)/**High** (approx. 7% brightness)/**Auto** (changes from **Low** to **High** depending on ambient brightness)

### Notes

- At low battery capacity, the LED will light approx. 3 s after camera activation.
- The LED switches off automatically when the viewfinder is in use.

Function	Behavior	Color	Notes
Camera is OFF Camera Standby No USB charging available	Off	-	-
Camera is OFF Camera Standby USB charging available	Dims on and off during charging process Lights continuously when battery is fully charged	Green	The green charging LED depends on the menu setting with one exception: With the menu setting <b>Off</b> or <b>Auto</b> , the brightness setting <b>Low</b> should be used to signal the charging process.
Camera switches to Standby mode	1x flash	White	Brightness depending on menu setting
Ready	Dimmed	White	
Problem	Dimmed	Red	<ul style="list-style-type: none"><li>- Desired function unavailable due to insufficient battery charge level</li><li>- Error message in the camera menu</li></ul>



## SHUTTER BUTTON

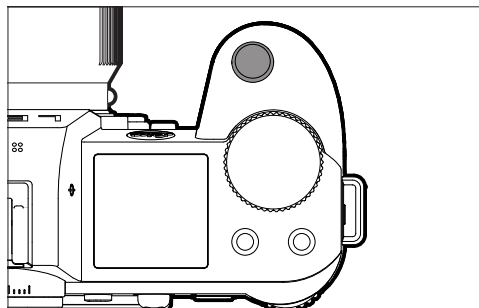

The shutter button works in two stages.

### 1. **Tapping** (= Pressing the shutter button to the 1st pressure point)

- Activating the camera electronics and displays
- Exposure lock (metering & saving):
  - AF mode: focusing (AF-Lock)
  - (semi) automatic exposure mode: exposure metering (AE-Lock)
- Canceling a running self-timer delay time
- Return to shooting mode
  - from review mode
  - from menu control
  - from standby mode

### 2. **Press down fully**

- Shutter release
- The data is then transferred to the memory card.
  - Starting a video shooting
  - Starting a preselected self-timer delay time
  - Starting a continuous shooting or interval shooting

### Notes

- Press down the shutter button in a smooth motion until you hear the click of the shutter to prevent camera shake.
- The shutter button remains locked:
  - if the memory card inserted and/or the internal buffer memory are (temporarily) full
  - if the battery has exceeded its performance limits (capacity, temperature, age)
  - if the memory card is write-protected or damaged
  - if the sensor is too hot



## LEFT DIAL

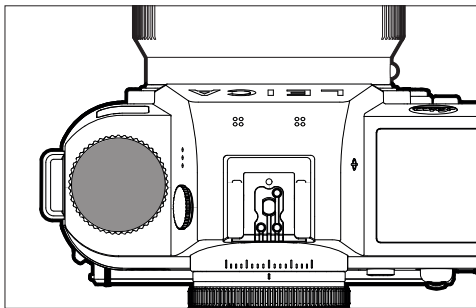

- In shooting mode: Setting ISO values

## RIGHT DIAL

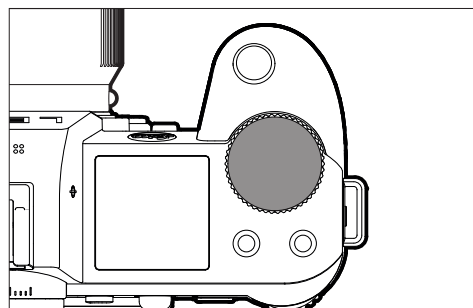

- Menu navigation
- Setting the shutter speeds
- Exposure compensation value selection
- Enlarging/reducing viewed images





## THUMBWHEEL

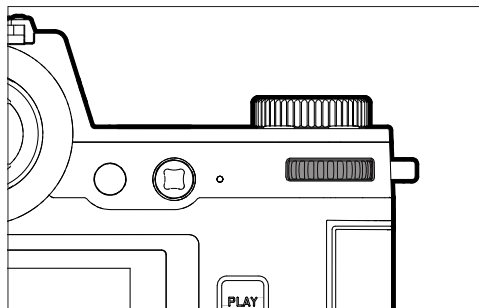

- Menu navigation
- Accessing the submenu
- Applying menu settings
- Setting selected menu items/functions
- Setting the aperture value
- Exposure compensation value selection
- Setting the program shift
- Scrolling through the gallery
- Playback of video recordings
- Confirming the prompts

## JOYSTICK

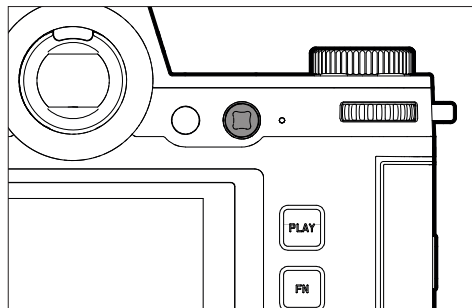

- Menu navigation
- Accessing the submenu
- Applying menu settings
- Setting selected menu items/functions
- Scrolling through the gallery
- Shifting the focus frame
- Exposure lock
- Playback of video recordings
- Confirming the prompts

## PLAY BUTTON/MENU BUTTON

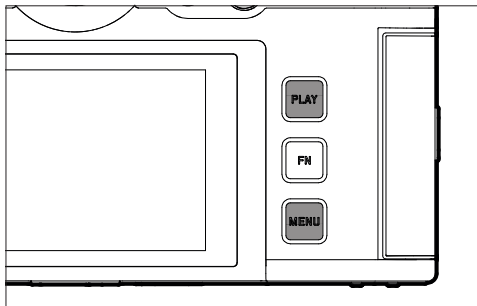

### PLAY BUTTON

- Activation and deactivation of the (continuous) review mode
- Return to full-screen display

### MENU BUTTON

- Accessing the menu (incl. Control Center)
- Accessing the Play menu
- Exiting the currently displayed (sub) menu



## FUNCTION BUTTONS

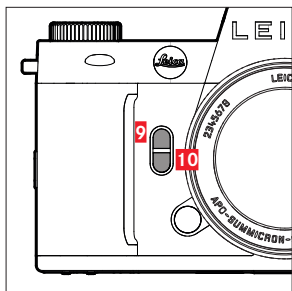
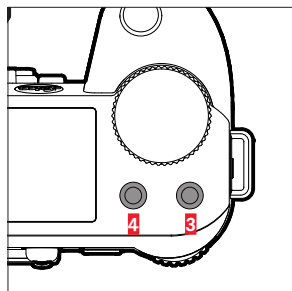
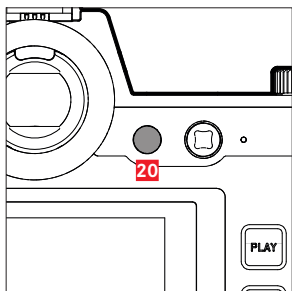
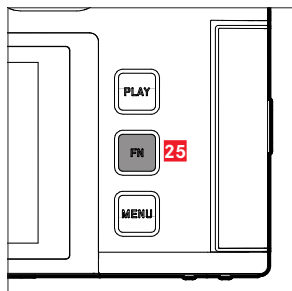

Direct access to various menus and functions. All function buttons can be custom configured (see p. 76).

## FACTORY SETTINGS

In shooting mode

In review mode

**FN button 25**

Toggle info profiles

**Function button 20**

LCD panel/EVF switchover

**Function button 4**

Mode change (photo/video)

Delete image

**Function button 3**

- Photo: ISO
- Video: ISO
- (Cine: Exposure Index)

Marking/rating a image









**Function button 9**

- Photo: Magnification
- Video: Microphone Gain

**Function button 10**

Autofocus metering method

## LCD PANEL (TOUCH SCREEN)

TOUCH CONTROL*		In shooting mode	In review mode	Menu	Control Center
	“tap”	Shifting the AF frame and focusing (while Touch AF is activated)	Selecting images	Confirm/Select	
	“double tap”	Resetting the AF frame (while Touch AF is activated)	Enlarging/reducing viewed images		
	“swipe”		Scrolling through the gallery Shifts the enlarged image section	Go back one level	
	“horizontal swipe”	Mode change (photo/video)	Scrolling through the gallery		Mode change (photo/video)
	“vertical swipe”	Switching to review mode	Switching to shooting mode	Scrolling	Switching to shooting mode
	“tap and hold”	Accessing the AF Quick Setting			Changing function button assignments
	“two-finger pinch” “two-finger spread”	Changing the size of the AF frame (using the AF modes <b>Field</b> and <b>Eye/Face/Body Detection</b> )	Enlarging/reducing viewed images		
	“swipe and hold” “hold and swipe”		Continuous scrolling		

\* A light touch is enough, don't apply pressure.



## TOP DISPLAY

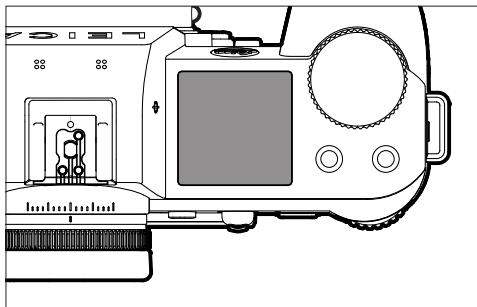

- Display of the active mode
- Display of image data
- Display of camera information

## MENU CONTROL

### CONTROL ELEMENTS

The following elements are used for menu control.

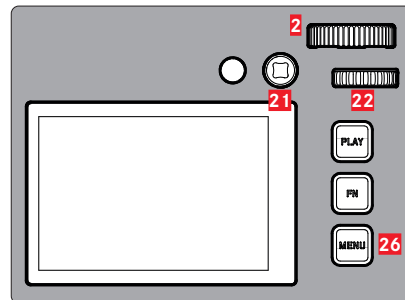

**21** Joystick

**2** Right dial

**26** MENU button

**22** Thumbwheel

## MENU SECTIONS

Two menu areas are available: Control Center and Main Menu.

Control Center:

- quick access to the most important settings

Main menu:

- offers access to all menu items
- contains various submenus

The currently active operating mode (Photo or Video) is highlighted in color in all menu areas.

Section	PHOTO	VIDEO
Control Center	Bright background	Dark background
Main menu	red line	yellow line

## CONTROL CENTER

Photo

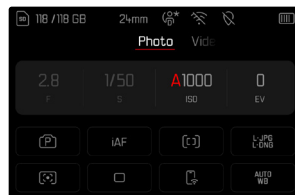

Video

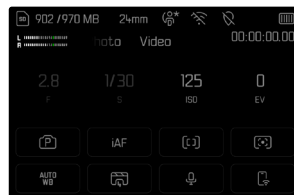

## MAIN MENU

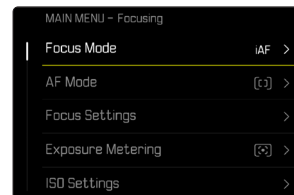
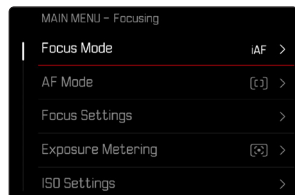



## SETTINGS IN PHOTO AND VIDEO MODE

The available settings depend on the operating mode (Photo or Video) currently in use.

- All menu items and their sub items available in the main menu before **Storage Management** are mode-specific. That means that any changes made here, will only apply for the operating mode currently in use. Any menu items of the same name in the other operating mode will be unaffected. That includes settings for focusing, exposure metering or white balance.
- All settings and functions after that in the main menu (including **Storage Management**) are available in both operating modes and have global effect. A setting selected in one of the modes will also apply to the other.

Settings and functions with global effect are:

- **Storage Management**
- **Leica FOTOS**
- **USB Charging**
- **USB Mode**
- **Wi-Fi**
- **User Profile**
- **Camera Settings**
- **Camera Information**
- **Language**



## SWITCHING MENU SECTIONS

The Control Center will always be displayed as the first menu section. The top level of the menu is organized into “pages”, which are displayed in the header: Control Center and several sections of the Main Menu. You can switch between menu sections by scrolling through the pages.

### Scrolling forward

- ▶ Press the **MENU** button

or

- ▶ Turn the right dial in clockwise direction
  - The Control Center will reappear after the last page of the Main Menu was displayed.

or

- ▶ Swipe up

### Scrolling backward

- ▶ Turn the right dial in anti-clockwise direction
  - The last page of the Main Menu will reappear after the Control Center was displayed.

or

- ▶ Swipe down

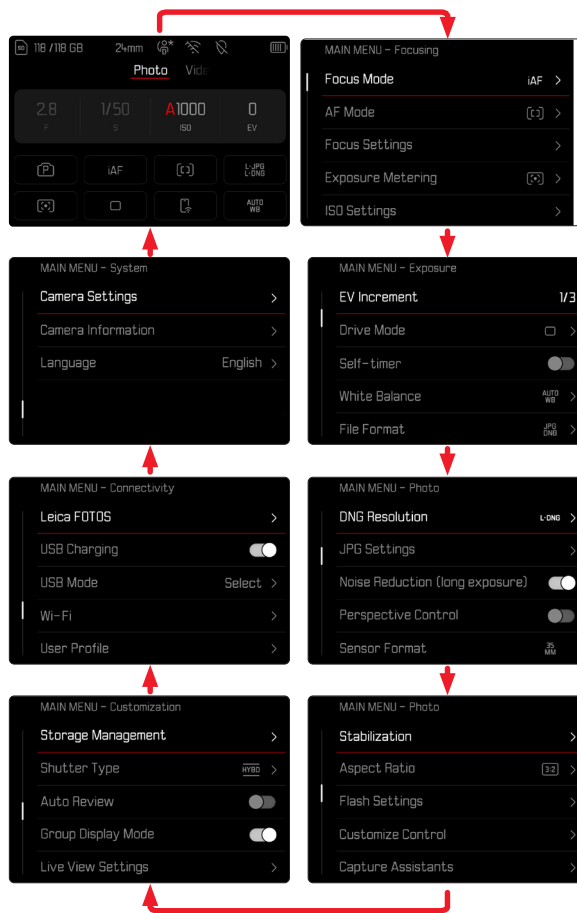



## CONTROL CENTER

The Control Center offers an overview of key data relating to the current camera status and active settings.

It furthermore allows direct access to important settings. The Control Center is optimized for touch control.

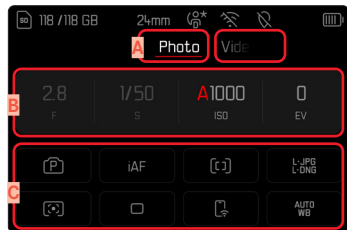

- A** Mode: photo/video (see p. 237)
- B** Exposure settings (see p. 146 and p. 266)
- C** Menu items

### Notes

- Where touch control is not possible or not desirable (e.g. in EVF mode), the Control Center can alternatively be controlled via the joystick and/or thumbwheel.
- The settings become effective immediately.
- All lit control panels can be selected. Automatically populated values are grayed out (depending on the currently active exposure mode).
- The available menu items in photo and video mode differ (see p. 30 and p. 32).

## CUSTOMIZING THE CONTROL CENTER

You can customize the Control Center to reflect your personal preferences. A number of functions can be selected.

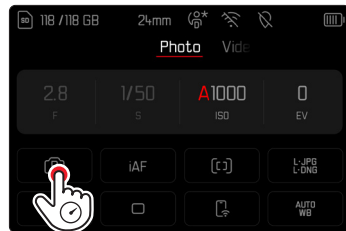

- White Balance
- iDR
- Sensor Format
- User Profile
- Shutter Type
- AF Profiles
- Format Storage
- Flash Settings
- Image Overlay
- Perspective Control
- Aspect Ratio

- ▶ Tap and hold the desired icon
  - A submenu opens.
- ▶ Select the desired menu item

## SETTINGS

There are a variety of options for changing settings from within the Control Center. The setting types vary from menu to menu.

- ▶ Tap the desired control panel
  - The relevant menu appears.

## DIRECT SETTINGS

A version of the menu bar appears in the lower area of the Control Center (see p. 72).



- ▶ Select the desired function directly or swipe

## ACCESSING A STANDARD SUBMENU

These menus behave as if they were accessed from within the main menu (see p. 69). Touch control is therefore unavailable. From there, you are returned to the Control Center and not the previous menu item.

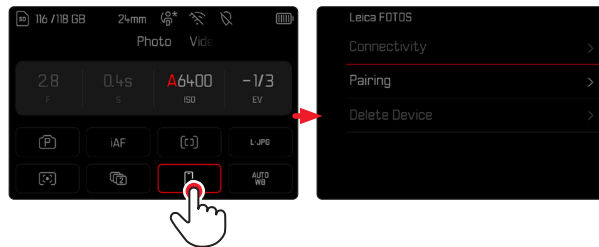

- ▶ Select the desired setting



## MAIN MENU

The main menu offers access to all settings. Most of these are organized in submenus.

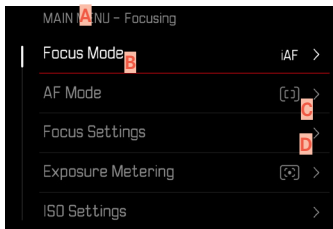

- A** Menu section: `Main Menu`
- B** Menu item name
- C** Menu item setting
- D** Submenu reference

### Notes

- The entire menu section can be controlled via joystick, dials, or touch.

## SUBMENU

There are various types of submenu available. The following pages describe their operation.

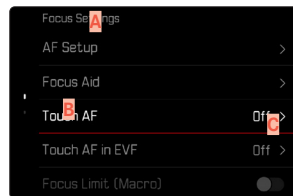
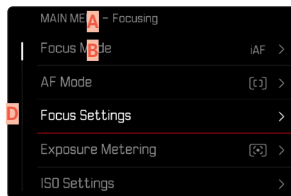

- A** Current menu item
- B** Submenu item
- C** References to other submenus
- D** Scrollbar

## MENU NAVIGATION

### SCREEN BY SCREEN NAVIGATION

#### Scrolling forward

- ▶ Press the **MENU** button (repeatedly if needed)

or

- ▶ Turn the right dial in clockwise direction
  - The Control Center will reappear after the last page of the Main Menu.

#### Scrolling backward

- ▶ Turn the right dial in anti-clockwise direction
  - The last page of the Main Menu will reappear after the Control Center was displayed.

## LINE BY LINE NAVIGATION

(Function/function option selection)

- ▶ Press the joystick up/down

or

- ▶ Turn the thumbwheel (to the right = down, to the left = up)
  - Once the last menu item has been reached scrolling up or down, the display will automatically jump to the previous or next screen. The currently active menu section (Favorites, Main Menu) is not exited.

or

- ▶ Swipe up

### Note

- Some menu items can only be accessed under specific circumstances. The text in the relevant line is displayed in gray to signify the existence of a submenu.





## SHOW SUBMENU

- ▶ Press the joystick/thumbwheel
- or
- ▶ Press the joystick to the right
- or
- ▶ Tap the menu item

## CONFIRM SELECTION

- ▶ Press the joystick/thumbwheel
  - The screen image changes back to the active menu item. The set function variant is shown on the right in the relevant menu line.

or

- ▶ Tap the menu item

### Note

- No confirmation is needed for the selection of **On** or **Off**. An automatic save is done.

## GO BACK ONE STEP

### (Return to the superordinate menu item)

- ▶ Press the joystick to the left
    - This option is only available for list-type submenus.
- or
- ▶ Swipe to the right

## GO BACK TO TOP MENU LEVEL

- ▶ Press the **MENU** button 1x
  - The top level of the currently selected menu section is displayed.

## EXITING THE MENU

You can exit the menus and submenus at any time – with/without applying the settings selected there.

### Go to shooting mode

- ▶ Tap the shutter button

### Go to review mode

- ▶ Press the **PLAY** button

## SUBMENU

### KEYBOARD/NUMBER PAD

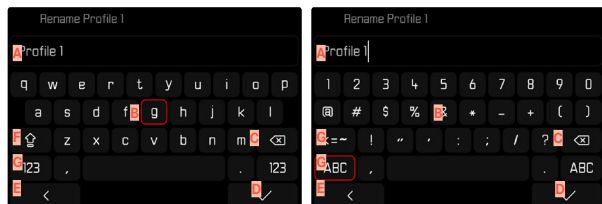

- A** Entry line
- B** Keyboard/Number pad
- C** “Delete” button (deletes the last character entered)
- D** “Confirm” button  
(to apply individual values and existing settings)
- E** Return to previous menu level
- F** Shift key (toggles between upper and lower case letters)
- G** Changing the character type

## SELECTING A BUTTON (ICON/FUNCTION BUTTON)

### Using button control

- ▶ Press the joystick in the relevant direction
  - The currently active button will be highlighted.
- ▶ Press the joystick/thumbwheel

or

- ▶ Turn the thumbwheel
  - The currently active button will be highlighted.
  - There will be an automatic jump to the next/previous line when the end/beginning of the line is reached.
- ▶ Press the joystick/thumbwheel

### Using touch control

- ▶ Press the button of your choice

### SAVE

- ▶ Select button **D**

### CANCEL

- ▶ Select button **E**





## MENU BAR

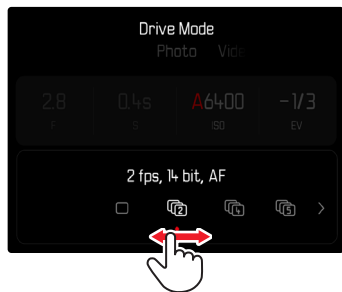

### Using button control

- ▶ Press the joystick left/right
- or
- ▶ Turn the thumbwheel

### Using touch control

- ▶ Select the desired function directly or swipe

### Notes

- The currently active setting displayed in the center is highlighted in red.
- The set value is displayed above the scale/below the menu bar.
- The following applies for direct access: The selected function requires no additional confirmation and will be active immediately.

## SCALE MENU

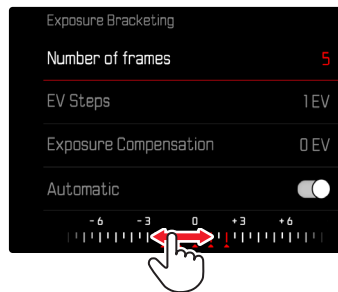

### Using button control

- ▶ Press the joystick left/right
- or
- ▶ Turn the thumbwheel

### Using touch control

- ▶ Select the desired setting directly or swipe

### Notes

- The currently active setting displayed in the center is highlighted in red.
- The set value is displayed above the scale/below the menu bar.



## DATE/TIME MENU

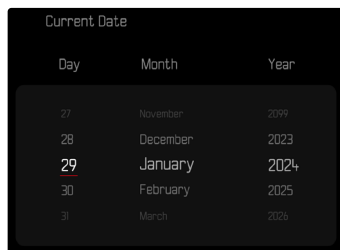

### Moving to the next settings field

- ▶ Press the joystick left/right

or

- ▶ Turn the thumbwheel

### Setting values

- ▶ Press the joystick up/down

### Saving and returning to superordinate menu item

- ▶ Press the joystick/thumbwheel

## COMBI MENU (AF PROFILES)

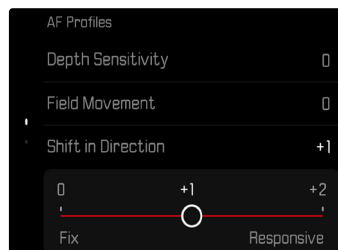

The setting of the individual menu items is done via a setting bar in the lower display area.

### Accessing individual menu items

- ▶ Press the joystick in the relevant direction

or

- ▶ Turn the thumbwheel

### Setting individual items

- ▶ Press the joystick/thumbwheel
  - The set value displayed next to the menu item is highlighted.

- ▶ Press the joystick left/right

or

- ▶ Turn the thumbwheel

### Applying the setting

- ▶ Press the joystick/thumbwheel

### Returning to the superordinate menu item

- ▶ Press the joystick to the left



## COMBI MENU (IMAGE PROPERTIES)

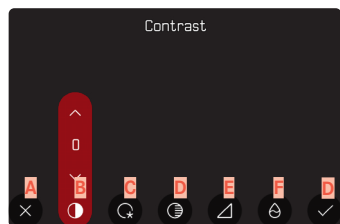

- A** “Back” button  
(Exit without saving)
- B** Menu item “Contrast”
- C** Menu item “Highlight”
- D** Menu item “Shadow”
- E** Menu item “Sharpness”
- F** Menu item “Saturation”
- G** “Confirm” button  
(Save and exit)

The operation is slightly different, depending on whether the settings are done via key control or touch control.

The screen image will remain visible continuously while settings are being adjusted. The result of the setting can be observed directly.



## Using button control

### **Navigating between buttons**

- ▶ Press the joystick left/right
  - An active button is indicated by a red frame.

### **Applying setting**

- ▶ Press the joystick up/down
  - The button toggles directly between each of the options.

or

- ▶ Press the joystick
  - All selectable options are displayed.
  - The “Parameter” button displays the currently set value for each of the parameter options.
- ▶ Press the joystick up/down
  - An active button is indicated by a red frame.
- ▶ Press the joystick
  - The options are no longer displayed.

## Using touch control

- ▶ Tap the desired button
  - All available options are displayed for the buttons “Parameter” and “Setting”.
  - The “Parameter” button displays the currently set value for each of the parameter options.
- ▶ Tap the desired alternative

### **SAVE**

- ▶ Select the “Confirm” button

### **CANCEL**

- ▶ Select the “Back” button





## USER-DEFINED OPERATION

### DIRECT ACCESS TO MENU FUNCTIONS

You can assign specific menu functions to the function buttons for extra quick direct access to menu items in shooting mode. The assignments in photo and video mode are completely independent of each other. The available functions are shown in the list on p. 63. For factory settings see p. 59.

### CHANGING AN ASSIGNMENT

All function buttons permit a quick and easy reassignment of functions in addition to access to their currently assigned menu function.

- ▶ Switch to the desired mode (photo or video)
- ▶ Press and hold the desired function button
  - The direct access appears on the LCD panel.

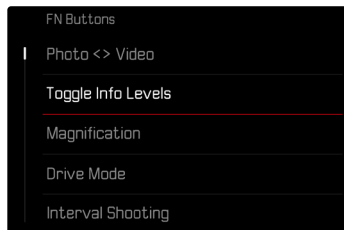

- ▶ Select the desired menu item

### ACCESSING THE ASSIGNED MENU FUNCTION

- ▶ Briefly press and release the desired function button
  - The assigned function is accessed, or a submenu appears on screen.

### Notes

- The submenus accessed via direct access may look differently than when they are accessed via the main menu. Specifically, they often appear as menu bars to allow quick settings.
- The settings can be done via key control or using touch control on the LCD panel. The operating mode depends on the type of submenu.

## DIAL ASSIGNMENTS

### (IN SHOOTING MODE)

The function of the two dials depends on the active exposure mode. Wheel assignments can be specified independently for photo and video mode and for every exposure mode. The two control elements can furthermore have functions assigned independently.

### FUNCTION ASSIGNMENT

- ▶ Switch to the desired mode (photo or video)
- ▶ Select **Customize Control** in the main menu
- ▶ Select **Dials**
- ▶ Select **Dials (AF lenses)/Dials (MF lenses)**
- ▶ Implementing the desired assignment



### Selecting the desired exposure mode

- ▶ Press the joystick up/down
  - Currently available assignment options are highlighted in red.

### Assigning a function to the thumbwheel

- ▶ Turn the thumbwheel
  - The available thumbwheel assignment options cycle through.

### Assigning a function to the right dial

- ▶ Turn the right dial
  - The assignment for the right dial cycles through the available functions.

### Saving the assignment and exiting the menu

- ▶ Press the joystick to the left
- or
- ▶ Tap the shutter button
- or
- ▶ Press the **MENU** button



## WHEN USING AF LENSES

The available functions are listed in the tables below (the factory setting is highlighted in bold).

### Photo mode

	Thumbwheel	Right dial
P	<b>Program shift</b> Exposure compensation ISO	Program shift <b>Exposure Compensation</b> ISO
S	<b>Exposure Compensation</b> Shutter speed ISO	Exposure compensation <b>Shutter speed</b> ISO
A	<b>Aperture</b> Exposure compensation ISO	Aperture <b>Exposure Compensation</b> ISO
M	<b>Aperture</b> Shutter speed ISO	Aperture <b>Shutter speed</b> ISO

### Video mode

	Thumbwheel	Right dial
P	<b>Microphone Gain</b> Exposure compensation ISO	Microphone Gain <b>Exposure Compensation</b> ISO
S	<b>Exposure Compensation</b> Shutter speed ISO	Exposure compensation Shutter speed <b>ISO</b>
A	<b>Aperture</b> Exposure compensation ISO	Aperture Exposure compensation <b>ISO</b>
M	<b>Aperture</b> Shutter speed ISO	Aperture Shutter speed <b>ISO</b>

## WHEN USING MF LENSES

The available functions are listed in the tables below (the factory setting is highlighted in bold).

### Photo mode

	Thumbwheel	Right dial
A	<b>Magnification</b> Exposure compensation ISO	Magnification <b>Exposure Compensation</b> ISO
M	<b>Magnification</b> Shutter speed ISO	Magnification <b>Shutter speed</b> ISO

### Video mode

	Thumbwheel	Right dial
A	<b>Magnification</b> Exposure compensation ISO	Magnification Exposure compensation <b>ISO</b>
M	<b>Magnification</b> Shutter speed ISO	Magnification Shutter speed <b>ISO</b>

## ROTATION DIRECTION OF THE DIALS

You can specify any rotation direction for exposure settings via the dials. You specify the rotation direction, which will result in an exposure reduction (shorter shutter speeds/smaller aperture).

The assignments for the two dials are done separately independent of each other in photo and video mode.

### THUMBWHEEL/RIGHT DIAL/LEFT DIAL

- ▶ Switch to the desired mode (photo or video)
- ▶ Select **Customize Control** in the main menu
- ▶ Select **Dials**
- ▶ Select **Dial Direction**

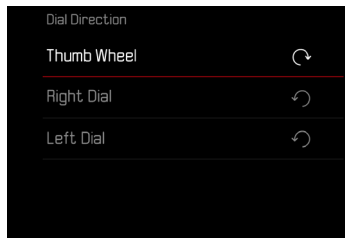



## JOYSTICK FUNCTIONS

### (IN SHOOTING MODE)

You can assign various functions to the joystick in photo mode. The settings for AF and MF mode are done separately. See p. 123, p. 139 and p. 157 for the various functions.

#### AF MODE

- ▶ Select **Customize Control** in the main menu
- ▶ Select **Joystick**
- ▶ Select **AF Mode**
- ▶ Select the desired setting  
(**AF-L**, **AE-L**, **AF-L + AE-L**)

#### MF MODE

- ▶ Select **Customize Control** in the main menu
- ▶ Select **Joystick**
- ▶ Select **MF Mode**
- ▶ Select the desired setting  
(**Magnification**, **AFs**, **AFs + AE-L**, **AFc**, **AFc + AE-L**, **AE-L**)

## LOCKING THE OPERATING ELEMENTS

Various operating elements can optionally be locked in shooting mode.

#### Note

-  Appears on screen when a operating element is used while the lock is active.

## LOCKING THE DIALS

- ▶ Select **Customize Control** in the main menu
- ▶ Select **Joystick**
- ▶ Activate **Dial Lock**

## LOCKING THE JOYSTICK

- ▶ Select **Customize Control** in the main menu
- ▶ Select **Dials**
- ▶ Activate **Joystick Lock**



## USER PROFILES

This camera allows the permanent storage of any menu settings, to e.g. access them quickly and easily for recurring conditions/image objects. Six memory slots are provided to store custom settings, plus the factory setting, which is always available and cannot be modified (**Default Profile**). You can assign names for the saved profiles yourself.

Any profiles configured for the camera can be saved to a memory card for use on another camera. Similarly, profiles saved on a memory card can be transferred to the camera.

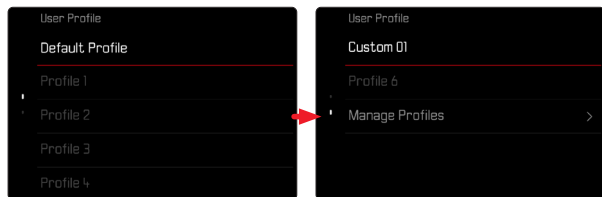

## CREATING PROFILES

Saving settings/creating a profile.

- ▶ Create custom settings for the desired functions via menu control
- ▶ Select **User Profile** in the main menu
- ▶ Select **Manage Profiles**
- ▶ Select **Save as Profile**
- ▶ Select a memory slot

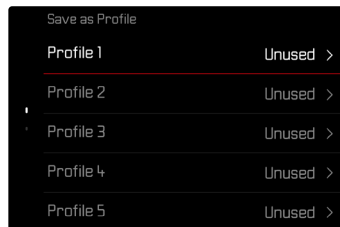

- ▶ Confirm the selection

### Notes

- Existing profiles are overwritten with the latest settings.
- A memory slot can only be deleted via the function **Reset Camera** described in the section “Resetting the camera to factory settings” (see p. 288).





## RENAMING PROFILES

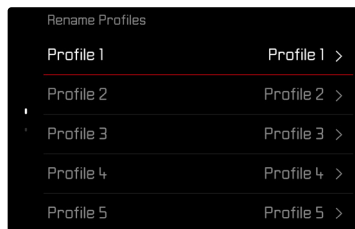

- ▶ Select **User Profile** in the main menu
- ▶ Select **Manage Profiles**
- ▶ Select **Rename Profiles**
- ▶ Select a profile
- ▶ Enter a name for the profile via the associated submenu keyboard and confirm your input (see p. 71)
  - Profile names must be between 3 and 10 characters in length.

## APPLYING/ACTIVATING PROFILES

Factory setting: **Default Profile**

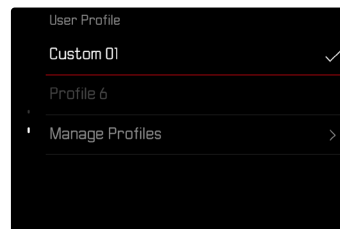

- ▶ Select **User Profile** in the main menu
  - A list of profile names is displayed.
- ▶ Select a profile
  - The selected profile is marked as **Active**.
  - Free memory slots appear in gray.

## EXPORTING/IMPORTING PROFILES TO/FROM THE MEMORY CARD



- ▶ Select **User Profile** in the main menu
- ▶ Select **Manage Profiles**
- ▶ Select **Export Profiles** or **Import Profiles**
- ▶ Confirm the selection

### Notes

- When importing and exporting, all profile slots are transferred to the card, i.e. including any empty slots. Any existing profiles stored in the camera will be overwritten, during the profile import. Individual profiles cannot be imported or exported.
- Any existing set of profiles will be replaced on the memory card during an export without an acknowledgment prompt.



## CAMERA BASIC SETTINGS

The two menu items **Language** and **Date & Time** appear automatically when switching the camera on for the first time, after a reset to factory settings (see p. 288), or after a firmware update. Additionally, you have the option to have the Leica FOTOS app set up the camera's **Date & Time** (including Time Zone and Daylight Saving Time). The settings will be automatically applied from those of your smartphone.

### MENU LANGUAGE

Factory setting: English

Available menu languages: German, French, Italian, Spanish, Portuguese, Russian, Japanese, Korean and Traditional or Simplified Chinese

- ▶ Select **Language** in the main menu
- ▶ Select your language
  - Aside from a few exceptions, the language will be changed for all information.

## DATE/TIME

### DATE

You can choose one of 3 options for the display sequence.

- ▶ Select **Camera Settings** in the main menu
- ▶ Select **Date & Time**
- ▶ Select **Date Setting**
- ▶ Select **Date Format**
- ▶ Select the desired date format  
(**Day/Month/Year**, **Month/Day/Year**, **Year/Month/Day**)
- ▶ Set the date

### TIME

- ▶ Select **Camera Settings** in the main menu
- ▶ Select **Date & Time**
- ▶ Select **Time Setting**
- ▶ Select **Time Format**
- ▶ Select the desired brightness  
(**12 Hours**, **24 Hours**)
- ▶ Set the time  
(Select **am** or **pm** for the 12-hour format)



## TIME ZONE

- ▶ Select **Camera Settings** in the main menu
- ▶ Select **Date & Time**
- ▶ Select **Time Zone**
- ▶ Select your time zone/current location
  - The Greenwich Mean Time offset is shown on the left of the line
  - Major cities in the relevant time zones are shown on the right

## DAYLIGHT SAVING TIME

- ▶ Select **Camera Settings** in the main menu
- ▶ Select **Date & Time**
- ▶ Select **Daylight Saving Time**
- ▶ Activate the function

## DISTANCE UNIT

The distance can be displayed in meters or in feet (see p. 125).

Factory setting: **Meter (m)**

- ▶ Select **Camera Settings** in the main menu
- ▶ Select **Distance Unit**
- ▶ Select the desired setting  
**(Meter (m), Feet (ft))**



## POWER SAVE MODE (STANDBY MODE)

The camera will switch to the power-saving standby mode after a preset time to extend battery life if this function is activated.

The device has two power save levels.

- Standby mode is activated after 30 s/1 min/2 min/5 min/10 min
- Automatic LCD panel shutdown (see p. 89)

Factory setting: 2 min

- ▶ Select **Camera Settings** in the main menu
- ▶ Select **Power Saving**
- ▶ Select **Auto Power Off**
- ▶ Activate the function
- ▶ Select **Settings**
- ▶ Select the desired setting  
(30 s, 1 min, 2 min, 5 min, 10 min)

### Note

- The camera can be woken from standby mode at any time by pressing the shutter button or by switching the main switch off and on again.

## LCD PANEL/VIEWFINDER SETTINGS

The camera comes equipped with a 3" liquid crystal color panel, which is protected by a glass cover made of extremely hard and scratch-resistant glass.

The following functions can be configured and used individually:

- Use of the LCD panel and EVF (electronic viewfinder)
- Eye sensor sensitivity
- Brightness
- Color rendering
- EVF Frame Rate
- Automatic LCD panel and EVF shutdown



## LCD PANEL/EVF USE

You can preset the situations in which EVF and LCD panel should be used. The displays appearing on screen and in the electronic viewfinder are identical.

The setting toggles to **LCD** automatically when the screen is folded out. The original setting resumes, once the screen is folded back in.

Factory setting: **Auto**

	EVF	LCD panel
<b>Auto</b>	The eye sensor in the viewfinder automatically toggles the camera between LCD panel and EVF. <ul style="list-style-type: none"> <li>• Shooting</li> <li>• Review</li> <li>• Menu control</li> </ul>	
<b>LCD</b>		<ul style="list-style-type: none"> <li>• Shooting</li> <li>• Review</li> <li>• Menu control</li> </ul>
<b>EVF</b>	<ul style="list-style-type: none"> <li>• Shooting</li> <li>• Review</li> <li>• Menu control</li> </ul>	
<b>EVF extended</b>	Only EVF is used for shooting mode. The eye sensor in the viewfinder automatically toggles the camera between LCD panel and EVF for review and menu control. <ul style="list-style-type: none"> <li>• Shooting</li> <li>• Review</li> <li>• Menu control</li> </ul>	

- ▶ Select **Display Settings** in the main menu
- ▶ Select **EVF <> LCD**
- ▶ Select the desired setting

### Note

- Select **EVF** if you want to keep the LCD panel switched off (e.g. on dark environments).

## EYE SENSOR SENSITIVITY

You can adjust the eye sensor sensitivity to ensure that the change-over functions reliably if you wear eyeglasses.

Factory setting: **High**

- ▶ Select **Display Settings** in the main menu
- ▶ Select **Eye Sensor Sensitivity**
- ▶ Select the desired setting



## BRIGHTNESS

You can adjust brightness for best visibility in various lighting conditions. Brightness is set individually for the LCD panel and the viewfinder. Selection occurs via key control or touch control.

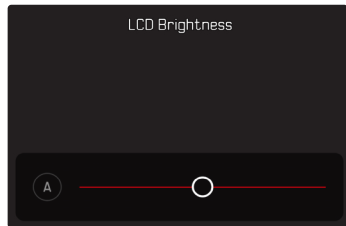

### LCD PANEL

- ▶ Select **Camera Settings** in the main menu
- ▶ Select **Display Settings**
- ▶ Select **LCD Brightness**
- ▶ Select the desired brightness or **A** (Auto)
- ▶ Confirm selection

### EVF

- ▶ Select **Display Settings** in the main menu
- ▶ Select **EVF Brightness**
- ▶ Look through the viewfinder
- ▶ Select the desired brightness
- ▶ Confirm selection

### Note

- The setting **Auto** is not available here.

## COLOR RENDERING

Color rendering can also be adjusted. Brightness is set individually for the LCD panel and the viewfinder. Selection occurs via key control or touch control.

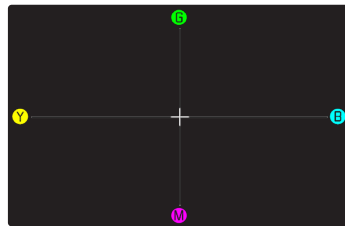

### LCD PANEL

- ▶ Select **Camera Settings** in the main menu
- ▶ Select **Display Settings**
- ▶ Select **LCD Color Adjustment**
- ▶ Select the desired color setting
- ▶ Confirm selection

### EVF

- ▶ Select **Display Settings** in the main menu
- ▶ Select **EVF Color Adjustment**
- ▶ Look through the viewfinder
- ▶ Select the desired color setting
- ▶ Confirm selection





## AUTOMATIC LCD PANEL AND EVF SHUTDOWN

The LCD panel and EVF deactivate automatically to save power. The time until power off can be set.

This setting also affects autofocus; the AF system will be deactivated at the time of automatic shutdown as well. We therefore recommend the **Off** setting if autofocus is to be used in HDMI recordings.

Factory setting: **1 min**

- ▶ Select **Camera Settings** in the main menu
- ▶ Select **Power Saving**
- ▶ Select **Displays/AF Auto Off**
- ▶ Activate the function
- ▶ Select **Settings**
- ▶ Select the desired setting  
(**30 s**, **1 min**, **5 min**)

## EVF FRAME RATE

The image frequency of the EVF can be set.

Factory setting: **60 fps**

- ▶ Select **Display Settings** in the main menu
- ▶ Select **EVF Frame Rate**
- ▶ Select the desired setting  
(**60 fps**, **120 fps**)

### Note

We recommend the **120 fps** setting for highly dynamic scenes. However, this setting will significantly increase power consumption.

## AUTOMATIC ROTATION OF THE INFO BAR

The info bar can be automatically rotated for shoots in vertical position. The content and sequence of the displayed data will not change.

Factory setting: **On**

- ▶ Select **Camera Settings** in the main menu
- ▶ Select **Display Settings**
- ▶ Select **Rotate Info Bars**
- ▶ Activate the function



## ACOUSTIC SIGNALS

Some functions can be acknowledged with acoustic signals. The following special functions can be configured separately:

- Electronic shutter sound
- AF confirmation
- Notification Signals

### VOLUME

The volume of active signals can be set.

Factory setting: **Low**

- ▶ Select **Camera Settings** in the main menu
- ▶ Select **Acoustic Signal**
- ▶ Select **Volume**
- ▶ Select **Low/High**

### ACOUSTIC SIGNALS

This setting specifies, whether the camera shout output general notification signals, e.g. during the delay time of the self-timer or as a warning signal, when the memory card is full.

Factory setting: **Off**

- ▶ Select **Camera Settings** in the main menu
- ▶ Select **Acoustic Signal**
- ▶ Select **Notification Signals**
- ▶ Activate the function

## ELECTRONIC SHUTTER SOUND

Factory setting: **Off**

- ▶ Select **Camera Settings** in the main menu
- ▶ Select **Acoustic Signal**
- ▶ Select **Electronic Shutter Sound**
- ▶ Activate the function

### AUTOFOCUS CONFIRMATION

A signal sound can be selected for successful AF settings.

Factory setting: **Off**

- ▶ Select **Camera Settings** in the main menu
- ▶ Select **Acoustic Signal**
- ▶ Select **AF Confirmation**
- ▶ Activate the function

### SILENT PHOTOGRAPHY

When pictures should be taken as quietly as possible.

- ▶ Select **Camera Settings** in the main menu
- ▶ Select **Acoustic Signal**
- ▶ Select **Electronic Shutter Sound/AF Confirmation/Acoustic Signals**
- ▶ Select **Off** for each of these menu items





## STILL IMAGE SETTINGS

### SENSOR FORMAT

The image data of the entire 35 mm sensor can be used or only a cropped section, which corresponds to the APS-C format. This can be helpful, e.g. when only limited storage capacity remains or a lens developed specifically for APS-C is used.

The max. available resolution is dependent on the setting of the sensor format.

Sensor format	DNG Resolution
35 mm	6000 x 4000 pixels (24 MP)
APS-C	3936 x 2624 pixels (10.3 MP)

#### Note

- The setting switches automatically to APS-C when an APS-C-specific lens is mounted.

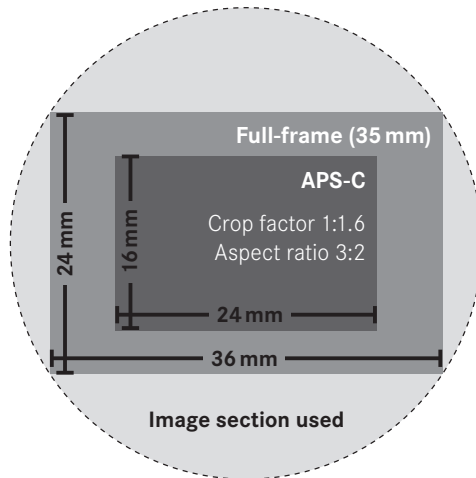

Factory setting: **35 mm**

- ▶ Select **Sensor Format** in the main menu
- ▶ Select the desired setting (**35 mm**, **APS-C**)
  - The set sensor format is shown in the header line.



## FILE FORMAT

Choose the JPG format **JPG** or the standardized raw data format **DNG** (= digital negative). Both can be used individually or simultaneously.

When creating JPGs, an initial processing occurs in the camera. Various parameters, including contrast, saturation, black level, or edge sharpness are set automatically. The result is then compressed and stored. The immediate result is an image that is optimized for various uses and a quick preview. For post-processing, on the other hand, DNG images are recommended.

DNG files contain all raw data as recorded by the camera sensor at the time the photo is taken. Special software (e.g. Adobe® Photoshop® Lightroom® or Capture One Pro®) will be needed to display DNG format files or to work with this format. Post-processing will allow exact adjustments of many parameters to your own expectations.

Factory setting: **DNG + JPG**



- ▶ Select **File Format** in the main menu
- ▶ Select a format (**DNG**, **DNG + JPG**, **JPG**)

### Notes

- The standardized DNG format is used for the storage of raw image data.
- The remaining number of shots shown in the LCD panel will not necessarily change after every shooting. That very much depends on the object; very fine image structures result in higher data quantities, while homogeneous surfaces mean less data.





## RESOLUTION

### DNG RESOLUTION

Three different resolutions (number of pixels) are available for shooting in raw data format (DNG).

All the benefits of DNG capture (like extensive color depth and high dynamic range) can therefore be used even if the image size is reduced.

Factory setting: **L-DNG (60.3 MP / 26.1 MP)**

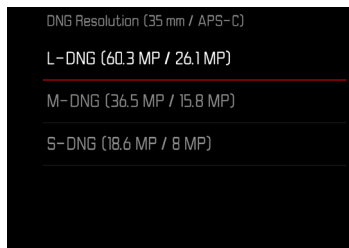

- ▶ Select **DNG Resolution** in the main menu
- ▶ Select the desired resolution (**L-DNG (60.3 MP / 26.1 MP)**, **M-DNG (36.5 MP / 15.8 MP)**, **S-DNG (18.6 MP / 8 MP)**)

The resolution also depends on the selected sensor format. The set sensor format is shown in the header line.

RESOLUTION	Sensor format	
	35 mm	APS-C
L-DNG	60.3 MP	26.1 MP
M-DNG	36.5 MP	15.8 MP
S-DNG	18.6 MP	8 MP

## JPG RESOLUTION

The **JPG** format setting offers 3 image resolution (number of pixels) options. The following file formats are available: **L-JPG**, **M-JPG** and **S-JPG**. This choice allows an alignment with the intended use and available memory card capacity.

Factory setting: **L-JPG**

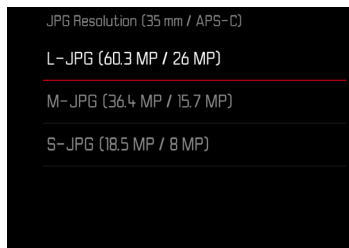

- ▶ Select **JPG Settings** in the main menu
- ▶ Select **JPG Resolution**
- ▶ Select the desired resolution

The resolution also depends on the selected sensor format. The set sensor format is shown in the header line.

RESOLUTION	Sensor format	
	35 mm	APS-C
L-JPG	60.3 MP	26 MP
M-JPG	36.4 MP	15.7 MP
S-JPG	18.5 MP	8 MP



## ASPECT RATIO

You have a choice of aspect ratios to select in addition to the basic 3:2 (e.g. 1:1). The relevant cropped section will be displayed. Images made in JPG format are saved with the relevant aspect ratio. DNG images will always have the natural sensor format (3:2), the set aspect ratio is only in aid of the image composition. In review mode, DNG images will be displayed with horizontal or vertical auxiliary lines showing the cropped section seen when shooting.

Factory setting: 3:2

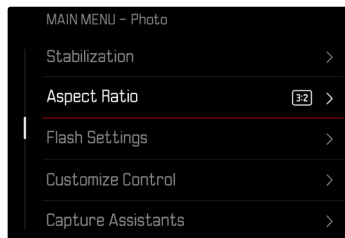

- ▶ Select **Aspect Ratio** in the main menu
- ▶ Select the desired setting (3:2, 7:5, 4:3, 1:1, 3:1, 16:9)

## IMAGE PROPERTIES

One of the many advantages of digital photography is that it is very easy to change essential image properties. The Leica SL3 offers two functions for the adjustment of JPG format frames: user-defined **Film Style** profiles, and professionally adapted, pre-defined **Leica Looks** profiles.

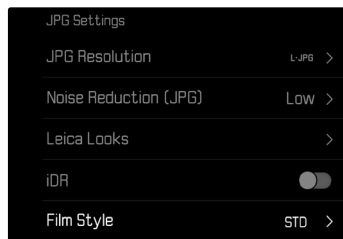

### Note

- The functions **Film Style** and **Leica Looks** can not be applied concurrently. When a profile is selected under **Film Style**, any profile selected previously under **Leica Looks** will be automatically deactivated, and vice versa.





## FILM STYLE

The image properties of JPG files can be changed slightly using several parameters. These are summarized in pre-configured **Film Style** profiles.

## CONTRAST

The contrast setting, i.e. the difference between light and dark image sections, determines whether an image comes across as “flat” or “brilliant”. Increasing or decreasing this difference impacts on contrast, meaning that some image sections are rendered brighter or darker.

## SHARPNESS

The impression of sharpness in a image is largely determined by edge sharpness, i.e. by how slight the transition area between light and dark is at edges in the image. Expanding or reducing these areas will therefore change the impression of sharpness.

## COLOR SATURATION

The saturation factor in color shots determines, whether colors in the picture appear “pale” and pastel-like or “vivid” and bright. While lighting conditions and weather (e.g. foggy/clear) are a given in terms of shooting conditions, their rendering can be influenced.

## HIGHLIGHT/SHADOW

Depending on the exposure selected and the dynamic scope of the object, some details in brighter or darker areas may no longer be clearly visible. The parameters **Highlight** and **Shadow** allow differentiated control over very brightly or less brightly lit areas. Where, for example, part of the object is in shadow, a higher setting for **Shadow** can help brighten these areas to make details more visible. Conversely, existing shadows or particularly bright areas might be additionally emphasized for reasons of image composition. Positive values will brighten the targeted areas, while negative values will darken them.



## COLOR PROFILE

3 pre-configured color profiles are available:

Factory setting: **Standard**

- STD **Standard**

- VIV **Vivid**

- NAT **Natural**

▶ Select **JPG Settings** in the main menu

▶ Select **Film Style**

▶ Select a profile

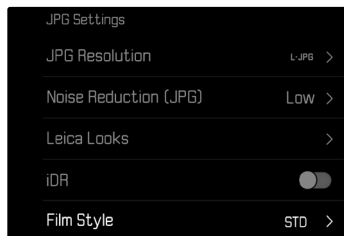

## MONOCHROME PROFILE

Two pre-configured monochrome profiles are available:

- **BW** **Monochrome**

- **BW** **Monochrome High Contrast**

▶ Select **JPG Settings** in the main menu

▶ Select **Film Style**

▶ Select a profile

## CUSTOMIZING PHOTO PROFILES

These parameters can be adjusted for all available profiles (Saturation only for color profiles). See p. 74 for details on menu operation.

- ▶ Select **JPG Settings** in the main menu
- ▶ Select **Film Style**
- ▶ Select **Film Style Settings**
- ▶ Select a profile
- ▶ Select **Contrast/Highlight/Shadow/Sharpness/Saturation**
- ▶ Select the desired level  
(-2, -1, 0, +1, +2)
- ▶ Confirm

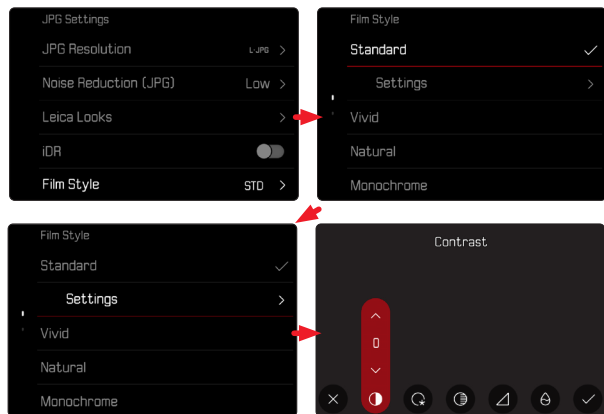

## LEICA LOOKS

Leica Looks offer a selection of professionally aligned, pre-defined profiles. These can be conveniently loaded to the camera via Leica FOTOS.

There are six memory slots available for Leica Looks.

### Applying a Look

- ▶ Select **JPG Settings** in the main menu
- ▶ Select **Leica Looks**
- ▶ Select a memory slot

### Selecting a memory slot

Leica Looks can be easily downloaded to the camera via Leica FOTOS.

- ▶ Connecting to Leica FOTOS
- ▶ Follow the instructions provided by the Leica FOTOS app

### Note

- The memory space assignments from the downloaded Leica Looks apply for photo and video mode alike. The various profiles can be selected individually for the two operating modes.

## AUTOMATIC OPTIMIZATION

### NOISE REDUCTION

#### NOISE REDUCTION FUNCTION FOR LONG-TERM EXPOSURE

In digital photography, the appearance of flawed pixels that can be white, red, blue or green is referred to as "noise". Image noise becomes more apparent when using higher sensitivities, particularly on uniform dark areas. Long exposure times may cause severe image noise. In order to reduce this annoying phenomenon, the camera will take a second "dark frame" (taken with the shutter closed) automatically after a shooting with slow shutter speed and high ISO value. The noise metered in this parallel image is then digitally "subtracted" from the data for the actual image. In such cases the message **Noise reduction in progress...** will appear with a relevant time value.

The doubling of the "exposure" time must be taken into account for long-term exposure times. The camera must not be switched off during that time. We recommend disabling Noise Reduction to allow shooting multiple frames in series and to apply noise reduction later during the post-editing stage. The images will have to be taken in raw data format.

Factory setting: **On**

- ▶ Select **Noise Reduction (long exposure)** in the main menu
- ▶ Select **On**

Under certain conditions, noise reduction will always be active as long as the function is enabled. That includes shots taken with the T function, as well as long-term exposure frames with shutter speeds of  $\geq +8$  s.

In all other cases, noise reduction depends on a combination of factors (specifically ISO setting, exposure time, and sensor temperature). The following table contains a list of shutter speeds typical for a sensor temperature of 25°C, at which noise reduction would be applied.

ISO	Shutter speed longer than
100	7 s
200	6.4 s
400	5.9 s
800	5.4 s
1600	4.9 s
3200	4.5 s
6400	4.2 s
$\geq 12\,500$	3.8 s

## NOISE REDUCTION IN JPG IMAGES

Except when high sensitivities are used, noise is luckily negligible. Nevertheless, noise reduction is a component of data processing when JPG files are generated. On the other hand, since it also has an effect on the focus review, you can optionally weaken or strengthen this noise reduction in comparison to the standard setting.

Factory setting: **Low**

- ▶ Select **JPG Settings** in the main menu
- ▶ Select **Noise Reduction (JPG)**
- ▶ Select the desired setting  
(**Low**, **Medium**, **High**)

### Note

- This setting will only affect images in JPG format.

## IMAGE STABILIZATION

The less favorable the lighting conditions during shooting, the slower will be the required shutter speeds for correct exposure. Visual image stabilization is a great tool for preventing out-of-focus images due to blurring.

Factory setting: **Auto**



- ▶ Select **Stabilization** in the main menu
- ▶ Select **Image Stabilization**
- ▶ Activate the function

## SETTING THE STABILIZATION DIRECTION

For camera pans it can be useful to only correct camera shake in specific directions.

Factory setting: **Normal**

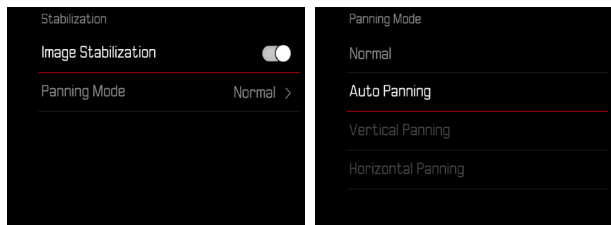

<b>Normal</b>	Camera shake in all directions (horizontal, vertical, rotational) will be corrected automatically.
<b>Automatic</b>	The camera recognizes the panning direction automatically and corrects orthogonal camera shake autonomously.
<b>Vertical Panning</b>	Only horizontal camera shake will be corrected.
<b>Horizontal Panning</b>	Only vertical camera shake will be corrected.

- ▶ Select **Stabilization** in the main menu
- ▶ Select **Panning Mode**
- ▶ Select the desired setting  
(**Normal**, **Auto Panning**, **Vertical Panning**, **Horizontal Panning**)

## Note

- Some lenses may not support all settings offered in the camera. Please contact Leica Customer Care if you have any questions (see p. 340).

## DARK AREA OPTIMIZATION (IDR)

### DYNAMIC RANGE

The contrast range of an object comprises all levels of brightness from the brightest to the darkest point in the image. All levels of brightness can be captured by the sensor, provided the contrast range of the object is lower than the dynamic range of the camera. In case of significant differences of brightness in the object (e.g. shootings of interior spaces with bright windows in the background, shootings with subject elements in shadow or directly lit by the sun, landscapes with dark areas and a very bright sky), the camera with its limited dynamic range will not be able to map the entire contrast range of the object. Information in 'edge areas' will be lost (under and overexposure).

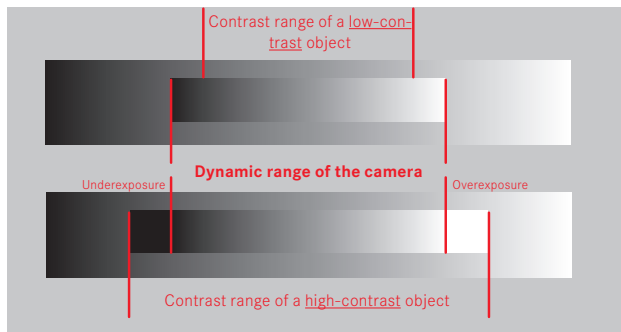

### IDR FUNCTION

The **IDR** (Intelligent Dynamic Range) function allows an optimization of the darker areas. Object details become much clearer. This function will only affect images in JPG format.



You can specify beforehand if and to what extent you want to optimize darker areas (**High**, **Standard**, **Low**, **Off**). In the **Auto** setting, the camera will automatically select the right setting depending on the contrast range of the object. In addition to that setting, the effect also depends on the exposure settings. The function will have the strongest effect in combination with low ISO values and fast shutter speeds. The effect is less pronounced with higher ISO values and/or slower shutter speeds.

Factory setting: **Auto**

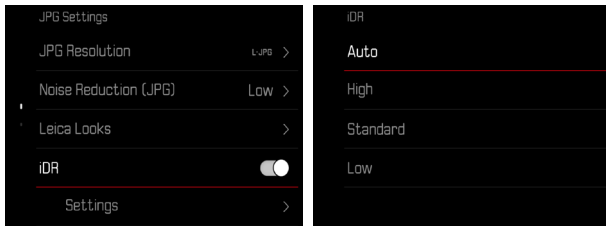

- ▶ Select **iDR** in the main menu
- ▶ Activate the function
- ▶ Select **Settings**
- ▶ Select the desired setting (**Auto**, **High**, **Standard**, **Low**)

### Notes

- The optimization of darker areas will slightly reduce differentiation in very bright areas.
- This function will only affect images in JPG format.

## DATA MANAGEMENT

### STORAGE OPTIONS

There are a number of options for saving data when two memory cards are inserted.

- **DNG+JPG on CFe=SD**
- **DNG+JPG first on CFe**
- **DNG on CFe / JPG on SD**

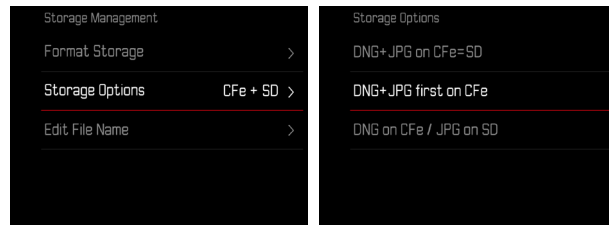

<b>CFe = SD (Backup)</b>	All files are saved to CFe and SD. One of the cards therefore serves as backup.
<b>CFe + SD (Standard)</b>	Files are saved to CFe first, until its capacity is reached. Subsequent files will then be saved to SD.
<b>CFe / SD (Split)</b>	Files are saved separately depending on their format: DNG files are saved to CFe, and JPG files to SD.



An icon in the Control Center denotes the selected setting.

Factory setting: **DNG+JPG first on CFe**

- ▶ Select **Storage Management** in the main menu
- ▶ Select **Storage Options**
- ▶ Select the desired setting  
(**CFe = SD**, **CFe + SD**, **CFe / SD**)

## FORMATTING A MEMORY CARD

Memory cards that have already been in use with this camera will usually not require formatting. An unformatted memory card that is inserted into the camera for the first time must be formatted. We recommend formatting memory cards from time to time, because residual data traces (data pertaining to individual shots) may reduce the card's memory capacity.

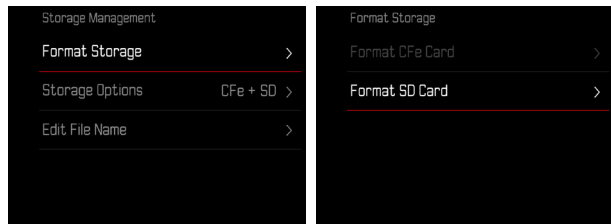

- ▶ Select **Storage Management** in the main menu
- ▶ Select **Format Storage**
- ▶ Select **Format CFe Card/Format SD Card**
- ▶ Confirm the selection
  - The status LED will flash during the process.



## Notes

- Never switch off the camera while data transfer is in progress.
- All data stored on the memory card will be lost during formatting. Formatting will not be prevented by a deletion protection set for individual shots.
- All images should therefore be regularly transferred to a safe mass storage medium, e.g. the hard disk of a computer.
- A simple formatting process will initially not irretrievably destroy existing data on the card. Only the directory will be deleted, which means the data will no longer be directly accessible. Data access can be restored with appropriate software. Only data that is overwritten when new data is saved will actually be irretrievable.
- A memory card should be formatted again in the camera if it was formatted in another device, e.g. a computer.
- Contact your retailer or Leica Customer Care for assistance if the memory card cannot be formatted/overwritten (see p. 340).

## DATA STRUCTURE

### FOLDER STRUCTURE

The files (= shots) on the memory cards are saved in automatically generated folders. The first three characters signify the folder number (numerals), the last five the folder name (letters). The first folder is assigned the name "100LEICA", the second "101LEICA". A folder will always be created with the next available number; you can have max. 999 folders.

### FILE STRUCTURE

The file names in these folders consist of eleven characters. In the factory settings, the first file is named "L1000001.XXX", the second "L1000002.XXX", etc. The first letter can be selected, the "L" from the factory settings denotes the camera brand. The first three characters signify the folder number (numerals). The next four digits denote the sequential file number. Once file number 9999 is reached, then a new folder will be automatically created, in which the file numbering begins at 0001 again. The last three places after the dot denote the file format (DNG or JPG).

## Notes

- When using memory cards that were not formatted with this camera, the file numbering will begin with 0001 again. Should the memory card already contain a file with a higher number, then numbering will be continued from that number.
- A relevant message will be displayed on the LCD panel once folder number 999 and file number 9999 are reached, and all numbering must be reset.
- Format the memory card and reset the frame number right after to reset the folder number to 100.

## EDIT FILE NAMES

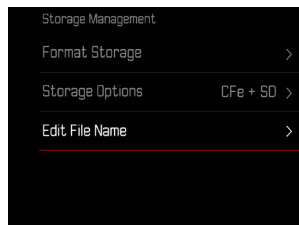

- ▶ Select **Storage Management** in the main menu
- ▶ Select **Edit File Name**
  - A keyboard submenu is displayed.
  - The input line contains the factory setting “L” as the first letter of the file name. Only this letter can be changed.
- ▶ Enter a letter of your choice (see p. 71)
- ▶ Confirm

## Notes

- The change to a file name applies to all subsequent files or until a new change is made. The sequential number will not be affected; but it will be reset when a new folder is created.
- During a reset to factory settings, the first letter will always be reset to “L”.
- Lower case letters are unavailable.



## CREATING A NEW FOLDER

- ▶ Select **Camera Settings** in the main menu
- ▶ Select **Reset Image Numbering**
  - A relevant prompt is displayed.
- ▶ Confirm the creation of a new folder (**Yes**) or cancel the new folder (**No**)

### Note

- The name part (first letter) of a new folder created this way remains unchanged. The file numbers in that folder will start again at 0001.

## ADDING COPYRIGHT INFORMATION

This camera allows you to enter letters and other characters as a copyright mark for your image files.

You can enter up to 20 characters of information under 2 headings per shot.

- ▶ Select **Camera Information** in the main menu
- ▶ Select **Copyright Information**
- ▶ Select **Copyright**
- ▶ Activate the function
- ▶ Select **Information/Artist**
  - A keyboard submenu is displayed.
- ▶ Enter the desired information (see p. 71)
- ▶ Confirm

## LOGGING THE SHOOTING LOCATION (ONLY IN CONNECTION WITH THE LEICA FOTOS APP)

Location information can be sourced from a mobile device in connection with the Leica FOTOS app. Current location information will then be written to the Exif data of the images (geotagging).



- ▶ Activating GPS functions on a mobile device
- ▶ Activate Leica FOTOS and connect to the camera (see chapter “Leica FOTOS”)
- ▶ Activate geotagging for this camera in Leica FOTOS

### Notes

- The use of GPS and associated technologies may be restricted in some countries or regions. Violations will be prosecuted by local authorities. You should therefore contact your travel agent or the embassy of your destination country for relevant information beforehand.
- It will take a few seconds for the Bluetooth connection to establish. The configured shutdown time should be considered when choosing a delay time if shutdown is enabled in the camera.
- All images with location information are marked with the geotagging icon in review mode.

## GEOTAGGING STATUS

The status of existing location information is displayed on screen, provided the info bars are displayed and geotagging is enabled. The Control Center will always show the current geotagging status.

	The location information is current (most recent geolocation max. 15 mins prior).
	The location information is not necessarily current anymore (most recent geolocation max. 12 h prior).
	The available location information is outdated (most recent geolocation more than 12 h in the past). No location data will be written to Exif data.
No icon	Geotagging is deactivated.

Location information will be continuously updated as long as the camera is connected to Leica FOTOS. The Bluetooth function of the camera and the mobile device must therefore remain enabled to ensure latest information. It is, however, not necessary for the app to be running in the foreground.



## DATA TRANSFER

Data can be conveniently transferred to mobile devices via Leica FOTOS. Alternatively, a card reader or USB cable can be used for the transfer.

### ABOUT LEICA FOTOS

- ▶ See chapter “Leica FOTOS” (p. 294)

### VIA USB CABLE OR “LEICA FOTOS CABLE”

The camera supports multiple data transfer options. A transfer mode can be permanently selected or chosen every time a connection is established.

Factory setting: **Select on Connection**

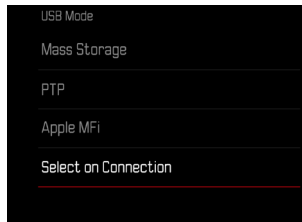

- ▶ Select **USB Mode** in the main menu
- ▶ Select the desired setting  
(**Mass Storage**, **PTP**, **Apple MFi**, **Select on Connection**)

- **Apple MFi** is used for the communication with iOS devices (iPhone and iPad)
- **PTP** allows a data transfer to computers using MacOS or Windows with PTP-capable programs, as well as tethering to Capture One Pro and Lightroom Classic
- The setting **Select on Connection** will automatically propose a connection method depending on the type of cable connection.

### Notes

- We recommend using a card reader for the transfer of large files.
- The USB connection must not be interrupted while data is being transferred, as the computer or the camera could otherwise “crash” and irreparable damage could occur on the memory card.
- The camera must not be turned off or automatically shut itself down due to a lack of battery power while data is being transferred, as this can cause the computer to crash. For the same reason, the battery must never be removed from the camera while the connection is active.





## PRACTICAL DEFAULT SETTINGS

### TOUCH AF

Touch AF allows a direct placement of the AF frame.

Factory setting: **Touch AF**

- ▶ Select **Focus Settings** in the main menu
- ▶ Select **Touch AF**



- ▶ Select **Touch AF**

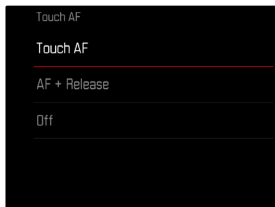

### Positioning the AF frame

- ▶ Tap the LCD panel in the desired position

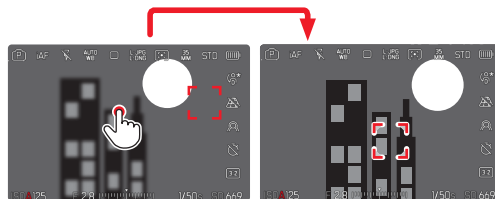

### Moving the focus frame back to the center of the screen

- ▶ Double-tap the LCD panel

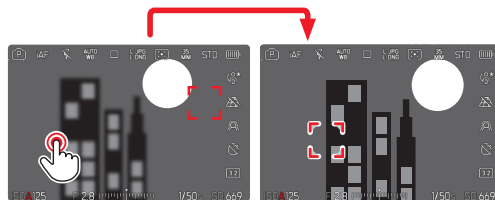

### Notes

- This function is available with all AF metering methods except **Multi-Field**.
- If the metering method **Tracking** is selected, the focus frame will remain at the selected position and autofocus commences when the shutter button is tapped. For all other AF metering methods, focusing occurs automatically.
- The position of the AF frame can only be reset with a double-tap, even if the setting is **Off**.





## TOUCH AF + SHUTTER BUTTON

The combination **Touch AF + Release** allows a direct placement of the AF frame for immediate recording.

- ▶ Select **Focus Settings** in the main menu
- ▶ Select **Touch AF**
- ▶ Select **Touch AF + Release**
- ▶ Tap the LCD panel in the desired position

### Note

- The AF frame cannot be reset as usual via a double tap if **Touch AF + Release** is activated.

## TOUCH AF IN EVF MODE

Touch AF is deactivated by default when EVF is in use to prevent any inadvertent altering of the AF frame. AF Quick Setting (see p. 246) continues to be accessible. This function can also be disabled if that is not wanted (e.g. when focusing with the left eye).

Factory setting: **Off**

- ▶ Select **Focus Settings** in the main menu
- ▶ Select **Touch AF in EVF**
- ▶ Select the desired setting  
(**On**, **AF Quick Setting only**, **Off**)
  - **AF Quick Setting only**
    - Accessing the AF Quick Setting (tap and hold)
  - **On**
    - Positioning the AF frame (tap)
    - Accessing the AF Quick Setting (tap and hold)
  - **Off**



## PERSONALIZED LENS SETTINGS

The total angle of rotation of the lens used for focusing can be individually adjusted. The setting selected indicates the angle of rotation required to change the focus setting from infinity to the nearest possible distance. Example: for a setting to **90°**, the entire focus range will be run through when the focus ring is turned by one quarter. A full turn of the focus ring will be needed for a setting to **360°**. Smaller values facilitate a faster, larger values a more precise adjustment. A setting to **Maximum** offers the highest precision.

Unlike the permanent settings, a setting to **Standard MF** will result in a non-linear dependency of rotation angle and focus setting. The extent of the change depends dynamically on the speed of rotation. With slow rotation, the same angle of rotation (e.g. 45°) causes a smaller change than with fast rotation.

Factory setting: **Standard MF**

- ▶ Select **Focus Settings** in the main menu
- ▶ Select **Manual Focus Throw**
- ▶ Select the desired setting  
(**Standard MF**, **90°**, **120°**, **150°**, **180°**, **210°**, **240°**, **270°**, **300°**, **330°**, **360°**, **Maximum**)

### Notes

- The settings **Standard MF** and **Maximum** are highly lens-dependent. **Maximum** may, for example, mean a rotation angle of 360° or 720°.

## EV INCREMENT

You can choose between 1/2 EV or 1/3 EV graduations. This will allow you to choose between stronger or more subtle effects for your relevant settings.

This setting doesn't just apply for exposure compensation settings. It also specifies the sensitivity of the dials in standard shooting mode, i.e. the increment width with which the shutter speeds and the aperture will be set. A setting to **1/2** will change the shutter speeds and aperture values that much faster each time the dial is moved one click further and the correct setting is achieved quicker. A setting to **1/3** facilitates a more precise setting.

Factory setting: **1/3**

- ▶ Select **EV Increment** in the main menu
- ▶ Select the desired setting  
(**1/2**, **1/3**)

## AUXILIARY DISPLAYS

The Leica SL3 has 4 independent info profiles, which contain differing combinations of the available auxiliary displays. The following functions are available:

- Info Bars (see p. 117)
- Grids (only shooting mode, see p. 118)
- Focus Peaking (see p. 118)
- Clipping (see p. 118)
- Level Gauge (only shooting mode, see p. 120)
- Histogram (see p. 121)

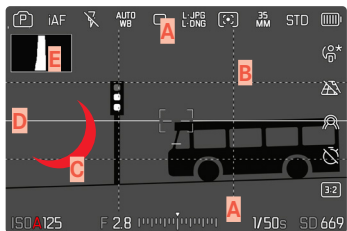

- A** Info bars (= header, footer, bar on the right)
- B** Grid lines
- C** Focus peaking
- D** Clipping
- E** Level gauge
- F** Histogram

## INFO PROFILES

Up to 4 independent profiles can be used. The desired function can be selected and adjusted individually for each profile. During operation, the switch between info profiles is done via direct access (see p. 76). In factory settings, that will be the **FN** button. It allows quick switches between various views.

The following profiles are predefined in the factory settings:

Profile	Factory Settings	
1	Info bars only (Top / Bottom)	
2	Full screen view (all auxiliary displays Off)	
3	Info Bars (Top / Bottom + Right), Clipping, Focus Peaking, Histogram	
4	Info Bars (Top / Bottom + Right), Grids, Clipping, Level Gauge	



## CHANGING THE INFO PROFILES

- ▶ Press the function button with the **Toggle Info Levels** assignment
  - In factory settings, that will be the **FN** button.

### Note

- The same info profiles are available in review mode as in shooting mode. The actual info profile currently in use, however, is saved separately.

## Briefly showing/hiding information

- ▶ Tap and hold the shutter button
  - (Only) the exposure information and currently active auxiliary functions will be visible.

## DEACTIVATING INDIVIDUAL INFO PROFILES

You can limit the number of info profiles by activating/deactivating individual profiles. At least one profile must always be active, but that can be an “empty” profile.

- ▶ Select **Capture Assistants** in the main menu
- ▶ Select a profile
- ▶ Select **On/Off**

## CUSTOMIZING THE INFO PROFILES

- ▶ Select **Capture Assistants** in the main menu
- ▶ Select a profile
- ▶ Select **Settings**
- ▶ Select the desired function
- ▶ Select the desired setting

Function	Available settings
Info Bars	Top / Bottom (On, Off) Right (On, Off)
Grids	3 x 3, 6 x 4, Off
Clipping	Off, Upper limit (value between 200 and 255)
Focus Peaking	On, Off Color (Red, Blue, Green, White) & Sensitivity (Low, Medium, High): Settings apply for <u>all</u> info profiles
Level Gauge	On, Off
Histogram	On, Off

### Note

- It is advisable to reserve one info profile as “empty”, in which all functions are set to **Off**. It allows you to temporarily hide all displays. In effect, you get an unobstructed view of the full screen image.

## SHOW AVAILABLE

### INFO BARS

The icons displayed represent currently active settings and exposure values. See chapter “Displays” for a full list of the various displays (see p. 30).

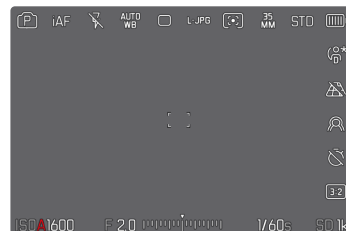



## GRID LINES

The grids divide the image frame into multiple fields. They facilitate pictorial composition and an exact camera orientation. The grid line distribution can be adjusted to fit the object.

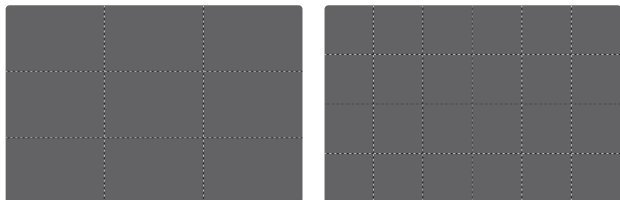

You can choose one of two grid displays. They divide the image field into 3x3 or 6x4 fields.

- ▶ Select **Capture Assistants** in the main menu
- ▶ Select a profile
- ▶ Select **Settings**
- ▶ Select **Grids**
- ▶ Select the desired setting  
(3 x 3, 6 x 4, Off)

## CLIPPING

The Clipping display marks very bright image areas. This function is a very easy and exact tool for checking the correct exposure setting. Overexposed areas flash black.

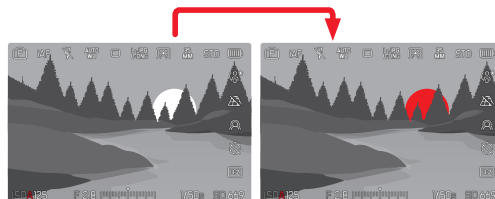

## SETTING THE LIMIT VALUE

You can set a threshold value for these displays, i.e. define a value at what degree of overexposure they will appear, so that you can adjust these displays to specific conditions or in line with your own composition ideas.

- ▶ Select **Capture Assistants** in the main menu
- ▶ Select a profile
- ▶ Select **Settings**
- ▶ Select **Clipping**
- ▶ Select **Upper Limit**
- ▶ Select the desired value  
(200 to 255)
  
- ▶ Tap and hold the shutter button
  - The clipping display appears.

## FOCUS PEAKING

This assist function highlights the edges of in focus subject elements in color. The color can be user-specified. The sensitivity can be additionally adjusted.

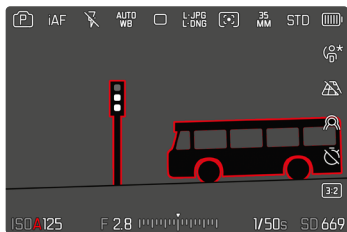

## HIGHLIGHT COLOR

The color can be user-specified. This setting will apply for all info profiles.

Factory setting: **Red**

- ▶ Select **Capture Assistants** in the main menu
- ▶ Select a profile
- ▶ Select **Settings**
- ▶ Select **Focus Peaking**
- ▶ Select **Color**
- ▶ Select the desired setting  
(**Red**, **Green**, **Blue**, **White**)

## SENSITIVITY

Factory setting: **Medium**

- ▶ Select **Capture Assistants** in the main menu
- ▶ Select a profile
- ▶ Select **Settings**
- ▶ Select **Focus Peaking**
- ▶ Select **Sensitivity**
- ▶ Select the desired setting  
(**Low**, **Medium**, **High**)

### Note

- Focus peaking is based on subject contrast, i.e. differences between light and dark. As a result, high contrast subject elements could be marked, even if they are not completely in focus.



## LEVEL GAUGE

The integrated sensors of the camera show its orientation. These indicators ensure exact camera orientation along the longitudinal and transverse axes of critical objects, e.g. architecture.

Deviations in relation to the longitudinal axis (i.e. when the camera is tilted up or down in the direction of view) are indicated by a short line in the center of the image (1). Deviations in relation to the transverse axis (when the camera is tilted to the left or right) are indicated by two long lines to the left and right of the image center (2).



- ▶ Select **Capture Assistants** in the main menu
- ▶ Select **Level Gauge**
- ▶ Select **On/Off**

### Note

- The camera will switch the aspect of the level gauge automatically for shoots in vertical format.

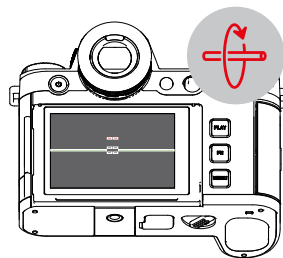
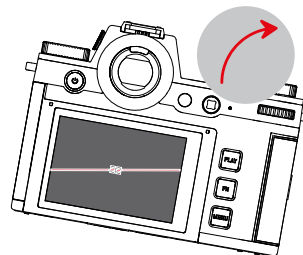
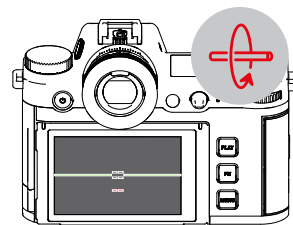
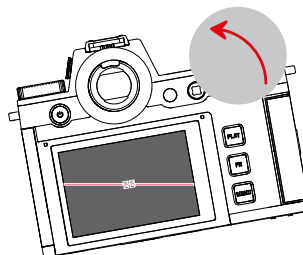
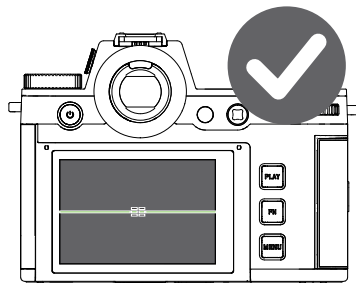



## HISTOGRAM

Histogram represents the brightness distribution in the image. The horizontal axis shows the graduated values from black (left) through gray to white (right). The vertical axis corresponds to the number of pixels at each brightness level.

This type of rendering allows an additional quick and easy assessment of the exposure setting.



- ▶ Select **Capture Assistants** in the main menu
- ▶ Select a profile
- ▶ Select **Settings**
- ▶ Select **Histogram**
- ▶ Select **On/Off**

## Notes

- The histogram is always based on the brightness displayed; depending on the settings used, it may not represent the final exposure.
- In shooting mode, the histogram should be regarded as a “trend indicator”.
- The histogram during rendering may differ slightly from the one during exposure.
- The Histogram always refers to the currently displayed cropped section of the image.



## TEMPORARY ACTIVATION/DEACTIVATION OF INDIVIDUAL FUNCTIONS

The following assist functions can be activated/deactivated temporarily:

- Focus peaking
- Clipping
- ▶ Assigning the desired assist function to a function button (see p. 76)
- ▶ Press the corresponding function button
  - The status of the assist function toggles On/Off.
  - A relevant indicator appears in the screen image.



The temporary setting is reset when the camera is switched off.

## ENHANCED LIVE VIEW

Image composition is often difficult in very dark environments (e.g. at night), as the objects are barely visible. The function **Enhanced Live View** will assist the image composition in such situations. The image is enhanced in Live View based on a significant increase in the ISO value and a reduced refresh rate. Image quality will not be impacted. Due to technical issues, there will, however, be image noise and severe tracer effects in Live View mode. This function will only be active in very low ambient light.

Depending on the selected exposure mode and other settings, Live View will display an exposure preview when the shutter release button is tapped and held (see section “Exposure control” beginning on page 157).

- ▶ Select **Live View Settings** in the main menu
- ▶ Select **Enhanced Live View**
- ▶ Select **On**

### Notes

- The function will be inactive even if **Enhanced Live View** is set to **On** if there is sufficient ambient light.
- In AF mode, the function **Enhanced Live View** will be intermittently inactive during range metering.
- **Focus Peaking** will be unavailable when **Enhanced Live View** is set to **On**.

## MF ASSIST FUNCTIONS

### AF ASSIST LAMP

The integrated AF assist lamp allows operation of the AF system in unfavorable lighting conditions. This lamp comes on while metering is performed, provided the function is activated.

Factory setting: **On**

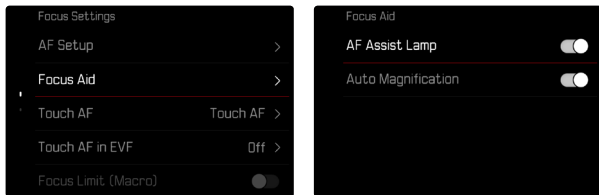

- ▶ Select **Focus Settings** in the main menu
- ▶ Select **Focus Aid**
- ▶ Select **AF Assist Lamp**
- ▶ Activate the function

### Notes

- The AF assist lamp illuminates an area of up to approx. 5 m.
- The AF assist lamp switches off automatically, once focusing was successful (AF frame is green) or has failed (AF frame is red).

## ACOUSTIC AF CONFIRMATION

You can set an acoustic confirmation signal for successful focus metering in AF mode.

Factory setting: **Off**



- ▶ Select **Camera Settings** in the main menu
- ▶ Select **Acoustic Signal**
- ▶ Select **AF Confirmation**
- ▶ Activate the function



## PHOTOGRAPHY

The settings described in this chapter only apply for photo mode. They are therefore part of the photo menu and must always be accessed and configured from within photo mode (see chapter “Camera operation” in the section “Menu Control”). Any menu items of the same name in the video menu are entirely independent of these.

### DRIVE MODE

The functions and settings described in the following generally refer to the exposure of individual shots. In addition to single frame shooting, the Leica SL3 offers a number of other exposure modes. Please read the relevant sections for information about functionalities and setting options.

- ▶ Select **Drive Mode** in the main menu
- ▶ Select the desired function options

Mode	Setting options / Variants
Single frame shooting	<b>Single</b>
Continuous shooting (see p. 162)	Speed: – <b>2 fps, 14 bit, AF</b> – <b>4 fps, 14 bit, AF</b> – <b>5 fps, 12 bit, AF</b> – <b>6 fps, 14 bit</b> – <b>7 fps, 12 bit</b> – <b>9 fps, 12 bit</b> – <b>15 fps, 12 bit</b>
Interval shooting (see p. 163)	<b>Number of Frames</b> Interval between the shootings ( <b>Interval</b> ) Delay time ( <b>Countdown</b> )
Exposure bracketing (see p. 165)	<b>Number of Frames</b> (3 or 5) <b>EV Steps</b> <b>Exposure Compensation</b> <b>Automatic</b>
Self-timer (see p. 167)	Delay time: – <b>Self-timer 2 s</b> – <b>Self-timer 6 s</b> – <b>Self-timer 12 s</b> – <b>Self-timer 30 s</b>

## FOCUSING

Your Leica SL3 allows automatic as well as manual focusing. There are 3 operating modes and 7 metering methods available for AF photography. Only manual setting options are available for MF lenses.

### AF PHOTOGRAPHY

- ▶ Select the desired AF mode
- ▶ Position the AF frame as needed
- ▶ Tap and hold the shutter button
  - Focusing occurs one time (AFs) or continuously (AFc).
  - Metering was successful: The AF frame lights up green.
  - Metering was unsuccessful: The AF frame lights up red.
  - Alternatively, focusing and/or exposure settings can be done and saved via the joystick (see “Metering memory lock” on p. 157).
- ▶ Shutter release

### MF PHOTOGRAPHY

- ▶ Select as focus mode **MF** (see p. 135)
- ▶ Use the focus ring to manually focus on the object
- ▶ Shutter release

Please read the following chapters for more information.

## AUTOFOCUS MODES

The following AF modes are available: **AFs**, **AFc** and **Intelligent AF**. The currently selected AF mode is shown in the header line.

Factory setting: **AFs**

- ▶ Select **Focus Mode** in the main menu
- ▶ Select the desired setting (**Intelligent AF**, **AFs**, **AFc**)

### INTELLIGENT AF (iAF)

In this mode, the camera will refocus as soon as it registers a color or brightness/contrast change in the entire image section. The focus field depends on the autofocus metering method selected.

#### AFs (single)

Suitable for objects with little or no movement. Focusing is done only once and the setting remains as long as the shutter button is held at the pressure point. That also applies if the AF frame is pointed at another object.

#### AFc (continuous)

Suitable for objects in motion. As long as the shutter button is held at the 1st pressure point, focusing is continuously adjusted to the object in the AF frame.





## AUTOFOCUS METERING METHODS

The AF mode offers various metering methods for focusing. A successful focus setting is identified by a green frame, an unsuccessful one is shown in red.

Factory setting: **Field**

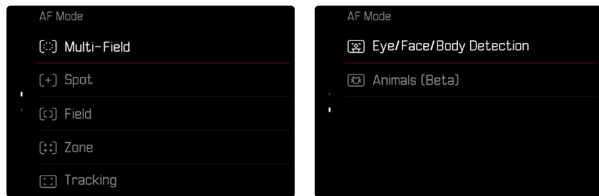

- ▶ Select **Focus Settings** in the main menu
- ▶ Select **AF Mode**
- ▶ Select the desired setting  
(**Multi-Field**, **Spot**, **Field**, **Zone**, **Tracking**, **Eye/Face/Body Detection**, **Animal Detection (Beta)**)

### Notes

- AF focusing can be unsuccessful:
  - if the distance to the object is too great (macro mode) or too small
  - if the object is not sufficiently illuminated
- Touch AF allows a direct placement of the AF frame. See p. 112 for more information.

## MULTI-FIELD METERING

Several focus areas are detected automatically. This function is particularly useful for snapshots.

### SPOT/FIELD METERING

Both methods detect only those parts of the object that are within the relevant AF frames. The metering fields are indicated by a small frame (field metering) or a cross (spot metering). The very small measuring range for spot metering allows focusing on tiny details of the subject.

The slightly larger measuring range in field metering is less critical for focusing, but still permits selective metering.

These metering methods can also be used for serial exposures in which the part of the object you want to focus on will always be at the same off-center position in the image.

Simply move the AF frame to another position (see p. 135).

## ZONE

With this metering method, subject sections are recorded with a coherent group comprising 5x5 fields. This function combines some security for snapshots with the option of aiming at larger objects reliably.

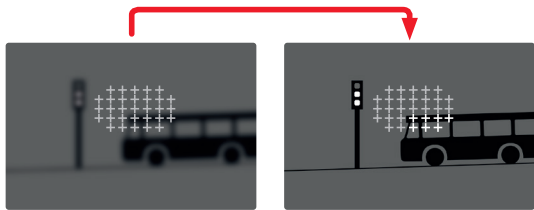

Once the setting has been made, the focus frames are displayed where object sections are displayed in focus.

## TRACKING

This field metering variant helps in the capture of moving objects. The focus on the object in the focus frame is continuously adjusted, once it is detected.

- ▶ Aim the focus frame at the desired object (by panning the camera shifting the focus frame)
  - ▶ Tap and hold the shutter button
- or
- ▶ Press the function button (provided it was assigned the function **AF-L** or **AF-L + AE-L**, see p. 157)
    - The camera focuses on the object.
  - ▶ Pan the camera to the desired cropped section
    - The focus frame “tracks” the saved object and focus is continuously adjusted.

### Note

- This metering method focuses continuously, even if the AF mode **AFs** was set.



## START POSITION FOR TRACKING

Factory setting: **Center**

You can specify the starting point for tracking.

<b>Center</b>	Center of the screen
<b>Last Position</b>	Ending position of the most recent tracking Example: A car drives through the picture from left to right. The picture is taken on the right edge of the frame. The subsequent measurement is taken at the right edge of the frame.
<b>Recall</b>	Starting position of the most recent tracking Example: A car drives through the picture from left to right. The picture is taken on the right edge of the frame. The subsequent measurement is taken at the left edge of the frame.

- ▶ Select **Focus Settings** in the main menu
- ▶ Select **AF Setup**
- ▶ Select **AF Tracking Start Position**
- ▶ Select the desired setting (**Last Position**, **Recall**, **Center**)

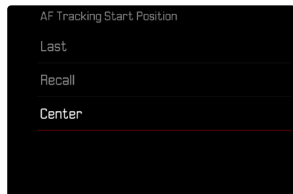

## PERSON DETECTION (FACE DETECTION)

Person detection is an expansion of the face detection feature. In addition to biometric patterns of faces, the camera also detects body patterns and uses them for focusing. Tracking will therefore continue, once a person is detected and measured, even if the face may not be in view at some point. This feature prevents inadvertent “jumps” to other faces if several persons are in the frame.

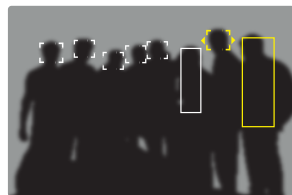
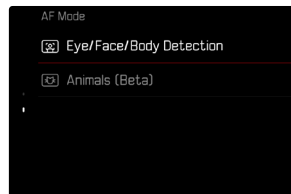



When face detection detects an eye, the focus will be on that eye. Should more than one eye be detected, then the user can choose the eye to focus on. The currently selected eye will be highlighted. Additionally, the desired face can be easily selected if there are several faces in the frame.

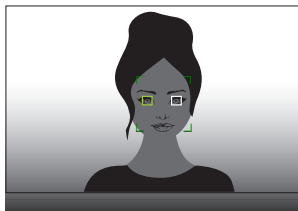

### toggling between faces and/or eyes

▶ Press the joystick in the relevant direction

### ANIMAL DETECTION

This version of Eye/Face/Body Detection also includes the recognition of some typical pet types.

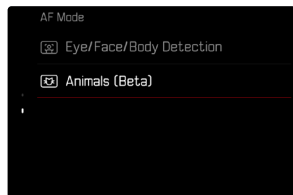

## AF SETTINGS

### AF PROFILES

Factory setting: **Children / Pets**

AF profiles allow optimal adjustments to the autofocus behavior depending on the type of object. You specify the sensitivity of the autofocus response to changes in the object.

There are 4 pre-defined AF profiles:

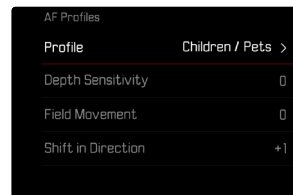
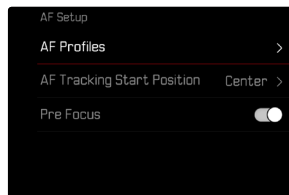

AF Profile	Typical situation
Children / Pets	Standard movements
Team Sports	Fast and unexpected change in direction
Runner	Constant movements
Wildlife	Sudden appearance, change in direction



Each of these profiles contains three parameters: **Depth Sensitivity**, **Field Movement** and **Shift in Direction**.

Higher values:	Lower values:
<b>Depth Sensitivity</b>	
Changes in the distance to the object are tracked immediately	The adjustment is delayed slightly to prevent unwanted focus jumps, should e.g. a person or object pass in front of the subject
<b>Field Movement</b>	
In case of movement from within the active focus field, the camera will switch to the next focus field as quickly as possible	Gradual switchover to adjacent focus fields to prevent errors due to slight movements
<b>Shift in Direction</b>	
The focus will immediately track sudden changes to the movement of the object	More robust focusing during steady movements

## ACCESSING THE ACTIVE PROFILE

- ▶ Select **Focus Settings** in the main menu
- ▶ Select **AF Setup**
- ▶ Select **AF Profiles**

## CHANGING THE ACTIVE PROFILE

- ▶ Accessing the active profile
  - ▶ Press the joystick/thumbwheel
    - The currently selected profile is marked as changeable by red lettering and two small white triangles on either side.
  - ▶ Press the joystick left/right
- or
- ▶ Turn the thumbwheel

## ADJUSTING THE ACTIVE PROFILE

- ▶ Accessing the active profile
- ▶ Select desired parameter
- ▶ Press the joystick/thumbwheel
- ▶ Setting the desired value

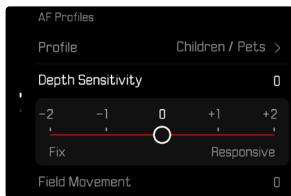

## RESETING THE ACTIVE PROFILE

- ▶ Accessing the active profile
- ▶ Press the joystick to the right
- ▶ Press the joystick/thumbwheel

## PRE FOCUS

When the function is active, the camera carries out a continuous depth mapping in realtime before the actual focusing. That allows a pre-identification of possible focus points in a scene. It speeds up the autofocus function significantly.

The pre-focus function is compatible with all AF modes and AF metering methods.

Factory setting: **On**

- ▶ Select **Focus Settings** in the main menu
- ▶ Select **AF Setup**
- ▶ Select **Pre Focus**
- ▶ Select **On/Off**





## FOCUS LIMIT

The focus area can be limited to the macro range. This will speed up automatic focusing considerably.

Factory setting: **Off**

- ▶ Select **Focus Settings** in the main menu
- ▶ Select **Focus Limit (Macro)**
- ▶ Select **On/Off**

### Notes

- The focusing range differs depending on the lens used (see relevant instructions).
- This function is not available for specific lenses:
  - lenses mounted via an adapter (e.g. Leica M lenses with L adapter M)
  - This function is available only for specific lenses.

## AF QUICK SETTING

The AF Quick Setting allows quick changes to the focus frame size in some AF metering methods.

The screen image will remain visible continuously while settings are being adjusted.

### ACCESSING AF QUICK SETTING

- ▶ Tap and hold the LCD panel
  - All auxiliary displays are hidden.
  - Red triangles appear at two corners of the focus frame if the metering method **Field/Zone/Eye/Face/Body Detection/Animal Detection (Beta)** is set.

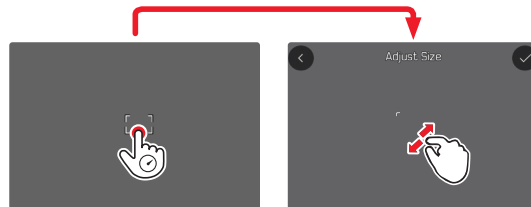

- In all other AF modes, the **AF Mode** menu bar will be displayed directly.

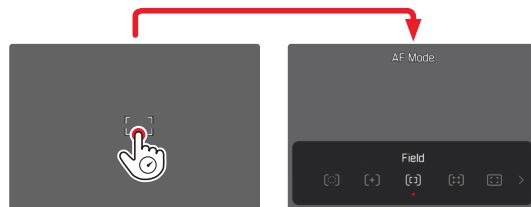

## ADJUSTING THE AF FRAME SIZE

(Field/Zone/Eye/Face/Body Detection/Animal Detection (Beta) only)

- ▶ Turn the thumbwheel

or

- ▶ Two-finger pinch/spread
  - The size of the AF frame is adjustable in 3 increments.

## CHANGING THE AF METERING METHOD

Should the active AF mode be Field or Eye/Face/Body Detection, then the user will have to access the AF Mode menu bar first:

- ▶ Press the function button at the front (bottom)
  - The AF Mode menu bar appears.
- ▶ Use the thumbwheel to select the desired metering method
  - Alternatively, you can use the right dial for the setting.
  - The setting is applied automatically after 3 seconds, the menu bar disappears.

### Note

- AF Quick Setting can only be accessed via the right dial if the function Touch AF is active (see p. 123).

## MF ASSIST FUNCTIONS

### ENLARGEMENT IN AF MODE

You can access the enlargement function independent of focusing for a better assessment of the settings.

The Magnification function must be assigned to one of the function buttons to use this feature (see p. 76).

Factory setting: Function button at the front (top)

### Assigning a function to a specific function button

- ▶ See p. 76

### Accessing the enlargement function

- ▶ Press the function button
  - An enlarged image section appears. The position of the enlargement depends on the position of the AF frame.
  - The rectangle within the frame at the top right represents the current magnification, as well as its position in the displayed cropped section.

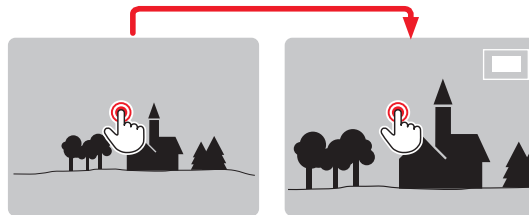



### Adjusting the enlargement function

- ▶ Turn the thumbwheel
  - The image section toggles between magnification factors.

### Changing the position of the enlarged section

- ▶ Press the joystick in the relevant direction

### Exiting the enlargement function

- ▶ Tap the shutter button

or

- ▶ Press the function button again

### Notes

- The enlargement function remains active until it is exited.
- The most recently magnification function will still be active the next time the feature is accessed.

### AF ASSIST LAMP

The integrated AF assist lamp allows operation of the AF system in unfavorable lighting conditions. This lamp comes on while metering is performed, provided the function is activated.

See p. 123 for settings.

### ACOUSTIC AF CONFIRMATION

You can set an acoustic confirmation signal for successful focus metering in AF mode (see p. 90).



## SHIFTING THE AF FRAME

All AF metering methods permit shifting the AF frame before focusing.

- ▶ Press the joystick in the relevant direction

or

- ▶ Tap the LCD panel in the desired position  
(While Touch AF is activated)

### Notes

- The focus frame will remain at the most recently used position for this AF metering method even if the user changes the AF metering method or the camera is switched off.
- The metering fields are joined together when the exposure metering method **Spot** is combined with the AF metering methods **Spot**, **Field** and **Zone**. Exposure metering will then occur at the point specified by the AF frame, even if it is moved.

### QUICK AF METERING POSITION CHANGES

The function **Toggle Focus Point** allows seamless changes between two metering positions in photo mode.

The position of the AF frame is reset to the center of the image when the function is initially accessed. Whenever the function is accessed after that, the AF frame will jump back and forth between the center of the image and the most recently used focus position.

The function **Toggle Focus Point** must be assigned to one of the function buttons (see p. 60).

### Note

- This function is available in the AF modes **Spot**, **Field**, **Zone** and **Tracking**.

## MANUAL FOCUSING (MF)

Focusing manually may in some situations be a better choice than autofocus.

- the same setting is used for several shoots
  - it would take longer to use the metering memory lock function
  - the setting is to be kept at infinity for landscape pictures
  - poor, i.e. very dark lighting conditions prevent AF operation or would slow it down
- ▶ Select **Focus Mode** in the main menu
  - ▶ Select **MF**
- ▶ Turn the focus ring until the desired part of the object is in clear focus





## MF ASSIST FUNCTIONS

The following assist functions are available in MF mode.

### FOCUS PEAKING

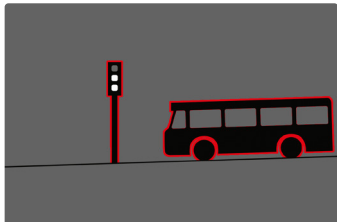
This assist function highlights the edges of in focus subject elements in color. The color can be user-specified. The sensitivity can be additionally adjusted. See p. 118 for settings.



When Focus Peaking is activated,  will appear to the right of the frame with a display of the color used. The color can be user-specified. The sensitivity can be additionally adjusted. The activation of this function is controlled vis the info profiles (see p. 115).

- ▶ Activate the function
- ▶ Turn the focus ring to mark the desired subject elements

#### Note

- Focus peaking is based on subject contrast, i.e. differences between light and dark. As a result, high contrast subject elements could be marked, even if they are not completely in focus.

## ENLARGEMENT IN MF MODE

The larger the details of the object are shown, the better you can assess their sharpness and the more accurately you can focus.

This function can be automatically activated during manual focusing or can be accessed independently.

### ACCESS VIA THE FOCUS RING

Turning the focus ring will automatically enlarge a image section.

- ▶ Select **Focus Settings** in the main menu
- ▶ Select **Focus Aid**
- ▶ Select **Auto Magnification**
- ▶ Select **On**
- ▶ Turn the focus ring
  - An enlarged image section appears. The position of the enlargement depends on the position of the AF frame.
  - The rectangle within the frame at the top right represents the current magnification, as well as its position in the displayed cropped section.



### Adjusting the enlargement function

- ▶ Turn the thumbwheel/right dial
  - The image section toggles between magnification factors.

### Changing the position of the enlarged section

- ▶ Move the position of an enlarged cropped section by swiping or
- ▶ Press the joystick in the relevant direction

### Exiting the enlargement function

- ▶ Tap the shutter button

### Note

- The enlargement will automatically return to normal viewing size about 5 s after the last movement of the focus ring.
- The most recently magnification function will still be active the next time the feature is accessed.

### ACCESS VIA THE FUNCTION BUTTON

You can access the enlargement function independent of focusing for a better assessment of the settings.

The **Magnification** function must be assigned to one of the function buttons to use this feature (see p. 76).

Factory setting: Function button at the front (top)

### Assigning a function to a function button

- ▶ See p. 76

### Accessing the enlargement function

- ▶ Press the function button
  - An enlarged image section appears. The position of the enlargement depends on the position of the AF frame.
  - The rectangle within the frame at the top right represents the current magnification, as well as its position in the displayed cropped section.

### Adjusting the enlargement function

- ▶ Turn the thumbwheel/right dial
  - The image section toggles between magnification factors.





### Changing the position of the enlarged section

- ▶ Move the position of an enlarged cropped section by swiping or
- ▶ Press the joystick in the relevant direction

### Exiting the enlargement function

- ▶ Tap the shutter button

### Note

- The enlargement function remains active until it is exited.

### DISTANCE DISPLAY

Distance information is shown in the top display during manual focusing.

- Focus Mode MF: when the shutter button is pressed to the first pressure point
- Focus Mode AF: when the shutter button is pressed and held at the first pressure point, followed by a turning of the focus ring

The unit of measure (m or ft) can be selected, see p. 85.

### Note

- The focus distance is estimated based on the focus position transmitted by the lens.

## USING AUTOFOCUS IN MF MODE

The joystick can be used as needed for automatic focusing. The AF modes AFs and AFc are available.

You can also concurrently carry out exposure metering and save the resulting value (see p. 157).

- ▶ Select **Customize Control** in the main menu
- ▶ Select **Joystick**
- ▶ Select **MF Mode**
- ▶ Select the desired setting  
(AFs, AFs + AE-L, AFc, AFc + AE-L)

The metering functions are distributed as follows while the joystick is pressed and held:

Menu settings	Joystick	Shutter button
AFs + AE-L AFc + AE-L	Exposure and focus	-
AFs AFc	Sharpness	Exposure

- ▶ Aim at the object
- ▶ Press and hold the joystick
  - The measurement is taken and saved.
- ▶ Store more measurements via the shutter button as needed
- ▶ Select the final image section
- ▶ Shutter release

## ISO SENSITIVITY

The ISO setting covers a range between ISO 50 and ISO 100 000, allowing you to adapt to the relevant situation as required.

There is more leeway for the use of preferred shutter-speed/aperture combinations when choosing an automatic ISO setting. You can set priorities within the scope of the automatic setting, e.g. for reasons of pictorial composition.

Factory setting: **Auto ISO**

## FIXED ISO VALUES

Values between ISO 50 and ISO 100,000 can be selected in 34 levels. Manual ISO settings are initially done in 1/3 EV steps.

Via the Control Center

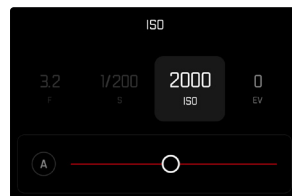
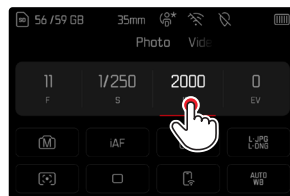

## Note

- When high ISO values are used or the image is edited later, image noise, as well as vertical and horizontal stripes may become visible, particularly in larger, evenly lit areas of the object.

## Using the dial

This function can be assigned to a setting dial.

Factory setting: Left Dial

### Assigning a function to a setting dial

- ▶ See p. 76

### Selecting a permanent value

- ▶ Tap and hold the shutter button
- ▶ Turn the dial to the desired value
  - Set values are shown at the bottom left of the LCD panel.



## AUTOMATIC SETTING

The camera automatically adjusts the sensitivity to ambient brightness and/or to the configured shutter-speed/aperture combination. In conjunction with aperture-priority mode, this function extends the range for automatic exposure control. The automatic setting of ISO sensitivity occurs in increments of 1/3 EV.

- ▶ Select **A**

### Via the Control Center

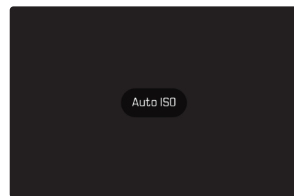
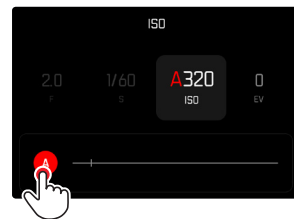
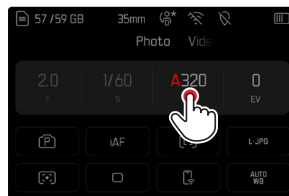

## LIMITING SETTING RANGES

A max. ISO value can be set, which will then limit the automatic setting (**Maximum ISO**). A max. exposure time can also optionally be configured. There are automatic settings and fixed max. shutter speeds  $1/2$ s and  $1/2000$ s available for that purpose. Separate settings are available for flash photography.

## LIMITING ISO VALUES

All values from ISO 200 are available.

Factory setting: **6400**

- ▶ Select **Auto ISO Settings** in the main menu
- ▶ Select **Maximum ISO**
- ▶ Select the desired value

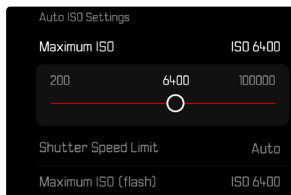
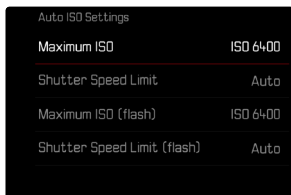

## LIMITING SHUTTER SPEED RANGES

Factory setting: **Auto**

- ▶ Select **Auto ISO Settings** in the main menu
- ▶ Select **Shutter Speed Limit**
- ▶ Select the desired value

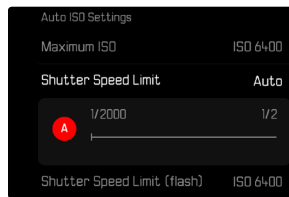

## LIMITING ISO VALUES (FLASH)

All values from ISO 200 are available.

Factory setting: **6400**

- ▶ Select **Auto ISO Settings** in the main menu
- ▶ Select **Maximum ISO (Flash)**
- ▶ Select the desired value

## LIMITING SHUTTER SPEED RANGES (FLASH)

Factory setting: **Auto**

- ▶ Select **Auto ISO Settings** in the main menu
- ▶ Select **Shutter Speed Limit (Flash)**
- ▶ Select the desired value

## DYNAMIC ISO SETTING

The thumbwheel can be configured to allow manual ISO settings in real time (see p. 76). The settings will cycle through all values available in the **ISO** menu. That means that **Auto ISO** can also be selected.

## FLOATING ISO

This function complements Auto ISO. Light strength changes with many zoom lenses when the focal length is changed. Floating ISO will in this situation adjust the sensitivity in fine graduations and will simultaneously ensure that the selected settings of aperture value and shutter speed remain constant in (semi) automatic exposure modes. This will specifically in video shootings prevent visible jumps in brightness.

Factory setting: **On**

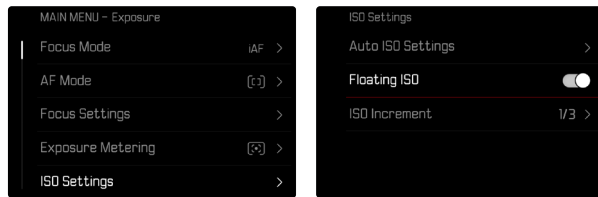

- ▶ Select **ISO Settings** in the main menu
- ▶ Select **Floating ISO**
- ▶ Select **On**

### Note

- **Floating ISO** can work only if the original ISO setting allows scope for change, i.e. the highest/lowest ISO setting is not already being used. The **Floating ISO** warning icon will be displayed in that case.

## WHITE BALANCE

In digital photography, White Balance ensures neutral color rendering in any light. White Balance relies on the setting made in the camera, which light color is to be rendered as 'white'.

Four methods are available:

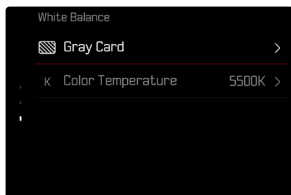
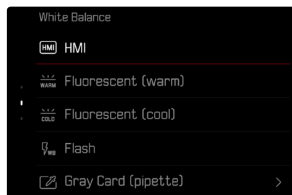
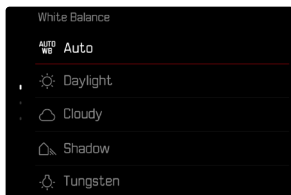

- automatic control
- fixed presets
- manual setting via metering
- direct setting of the color temperature

Factory setting: **Auto**



## AUTOMATIC CONTROL/FIXED SETTINGS

- **Auto**: for automatic control, which delivers neutral results in most situations
- Various fixed presets for most frequently encountered light sources:

	Daylight	For outdoor shootings in sunlight
	Cloudy	For outdoor shootings in cloudy conditions
	Shadow	For outdoor shootings with the main subject in shadow
	Tungsten	For indoor shootings with (predominantly) incandescent lamp light
	HMI	For indoor shootings with (predominantly) light from metal halide lamps
	Fluorescent (warm)	For indoor shootings with (prevailing) light from fluorescent tubes with warm light color
	Fluorescent (cool)	For indoor shootings with (prevailing) light from fluorescent tubes with cool light color
	Flash	For flash photography

- ▶ Select **White Balance** in the main menu
- ▶ Select the desired setting



## MANUAL SETTING VIA METERING

( Gray Card / Gray Card (pipette))

This metering variant captures all color hues in the metering field and uses these to calculate a mean gray value. The variant **Gray card** is suited best for subjects in which you can clearly identify a neutral gray or pure white area. If that is not the case, or should you wish to base your metering on an off-center detail, then **Gray Card (pipette)** will be a better choice.

### Note

- A value configured using this method will remain unchanged (i.e. it will be used for all subsequent photographs) until new measurements are taken or one of the other white balance settings is selected.

## GRAY CARD (PIPETTE)

This metering variant captures only the color hue metered within the metering field and calculates the mean gray value from it.

- ▶ Select **White Balance** in the main menu
- ▶ Select **Gray Card (pipette)**
  - The following appears on the LCD panel:
    - the image based on automatic white balance
    - a cross in the middle of the image



- ▶ Aim the metering field at a white or neutral gray area

### Repositioning the focus frame

- ▶ Press the joystick in the relevant direction

### Performing measurement

- ▶ Shutter release

or

- ▶ Press the joystick/thumbwheel
  - The measurement is taken.

### Cancelling measurements

- ▶ Press the **FN** button



## GRAY CARD

This metering variant captures all color hues in the metering field and uses these to calculate a mean gray value.

- ▶ Select **White Balance** in the main menu
- ▶ Select **Gray Card**
  - The following appears on the LCD panel:
    - the image based on automatic white balance
    - a frame in the center of the image

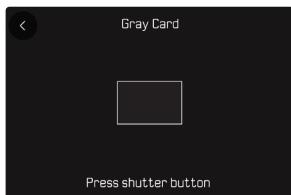

- ▶ Aim the metering field at a white or neutral gray area
  - The screen image changes dynamically in line with the reference area in the frame.

## Performing measurement

- ▶ Shutter release

or

- ▶ Press the joystick/thumbwheel
  - The measurement is taken.

## Cancelling measurements

- ▶ Press the **FN** button

## DIRECT SETTING OF THE COLOR TEMPERATURE

Values between 2000 and 11500 K (Kelvin) can be set directly. That gives you a very wide range, which covers virtually all color temperatures occurring in real life and within which you can adapt color rendering to any light color and your personal preferences with incredible detail.

Factory setting: **5500 K**



- ▶ Select **White Balance** in the main menu
- ▶ Select **Color Temperature**
- ▶ Select the desired value





## EXPOSURE

The exposure setting is done dynamically via the two dials. As a rule, the thumbwheel controls the aperture and the right dial the shutter speed. The “free” dial is used for quick access to exposure compensation during semi automatic exposure setting. Function assignments can be modified, see p. 77.

Exposure settings can be done quickly and easily via the Control Center.

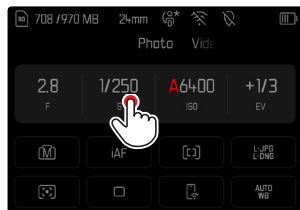

- ▶ Tap the desired control panel
  - The active control panel is highlighted in red.
  - A setting band appears instead of the light balance. A dot marks the current setting. The current setting value is displayed above the dot.

- ▶ Tap the setting band briefly in the desired position, or drag the dot to the desired position

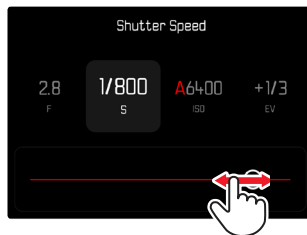

## SHUTTER TYPE

The Leica SL3 comes equipped with a mechanical shutter and a purely electronic shutter function. The electronic shutter expands the available shutter area and functions completely noiseless, which may be important in some work environments.

Factory setting: **Hybrid**

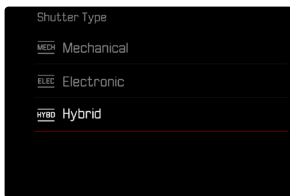

- ▶ Select **Shutter Type** in the main menu
- ▶ Select the desired setting  
(**Mechanical**, **Electronic**, **Hybrid**)

<b>Mechanical</b>	Only the mechanical shutter is used. Working range: 60 min to 1/8000 s.
<b>Electronic</b>	Only the electronic shutter function is used. Working range: 60 s to 1/16000 s.
<b>Hybrid</b>	You can add the electronic shutter function if you need faster shutter speeds than can be achieved with the mechanical shutter. Working range: 60 min to 1/8000 s + 1/8000 s to 1/16000 s.

## USE

The classic shutter sound of the mechanical shutter conveys an auditive feedback. It is well suited for long-term exposures, as well as for shots of moving objects.

The electronic shutter function allows photography with an open aperture in very bright due to very fast shutter speeds. The distinctive “rolling shutter” effect makes it less suitable for moving objects.

## Notes

- The electronic shutter function does not allow flash photography.
- The electronic shutter function in combination with fast shutter speeds can result in stripe effects on the images when used with LED or fluorescent tube lighting.









## EXPOSURE METERING METHODS

The following exposure metering methods are selectable.

Factory setting: **Multi-Field**

-  Spot
-  Center-weighted
-  Highlight-Weighted
-  Multi-field

- ▶ Select **Exposure Metering** in the main menu
- ▶ Select the desired metering method  
(**Spot**, **Center-Weighted**, **Highlight-Weighted**, **Multi-Field**)
  - The selected metering method is displayed in the header line of the screen image.

Spot metering allows a shifting of the focus point:

- ▶ Press the joystick in the relevant direction

### Notes

- The exposure information (ISO value, aperture, shutter speed and light balance with exposure compensation scale) will help to determine the settings required for correct exposure.
- The most important displays (ISO value, aperture and shutter speed) will also appear in the top display.

## SPOT

This metering method is concentrated exclusively on a small area in the center of the image. The metering fields are joined together when the exposure metering method **Spot** is combined with the AF metering methods **Spot** and **Field**. Exposure metering will then occur at the point specified by the AF frame, even if it is moved.

## CENTER-WEIGHTED



This method considers the entire image field. The subject elements captured in the center will, however, impact on the calculation of the exposure value more so than areas around the edges.

## MULTI-FIELD

This metering method is based on the detection of multiple values. These values are used in an algorithm to calculate an exposure value appropriate for a good rendering of the assumed main subject.

## HIGHLIGHT-WEIGHTED

This method considers the entire image field. The exposure value will, however, be adjusted to very bright subject elements. That prevents the overexposure of bright subject elements without having to measure them individually. This metering method is particularly useful for objects that are significantly more brightly lit than the rest of the image (e.g. people in a spotlight), or that reflect the light significantly (e.g. white clothing).

Multi-field	Highlight-weighted
	
	
	

## EXPOSURE MODES

There are four exposure modes available to adjust the rendering of the object or to create the desired pictorial composition:

- Program AE mode (**P**)
- Aperture-priority mode (**A**)
- Shutter-priority mode (**S**)
- Manual setting (**M**)

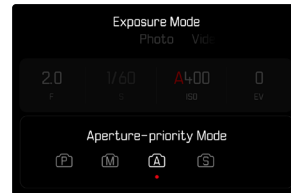
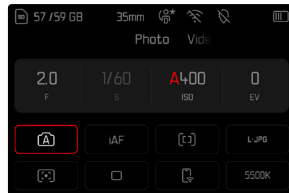

## SELECTING A MODE

### Via the thumbwheel

- ▶ Press the thumbwheel
  - The currently selected mode is shown in the top display. The currently selected mode is marked in red on screen.
- ▶ Turn the thumbwheel to select the desired mode
  - The mode display changes in the top display and on screen. All modes can be reached by turning the wheel in either direction.
  - The selected mode will be applied automatically approx. 2 s after the thumbwheel is moved the last time.



### Applying the selected mode immediately

- ▶ Press the joystick/thumbwheel
- or
- ▶ Tap the shutter button

### Via the Control Center

- ▶ Tap the control panel

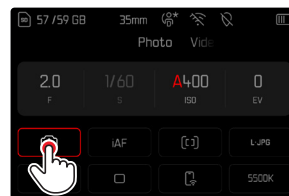

- ▶ Tap the desired exposure mode

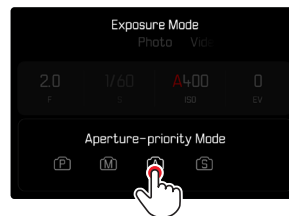

## In shooting mode

- ▶ Tap the control panel in the top info bar



- ▶ Tap the desired exposure mode

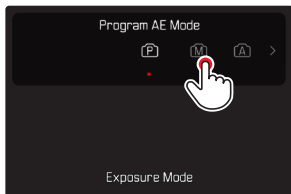

## Note

- When using a lens with an aperture ring (e.g. Leica M lenses), only the exposure modes **A** (aperture-priority) and **M** (manual setting) will be available. Where that is the case, **F0.0** is displayed as the aperture value.

## FULLY AUTOMATIC EXPOSURE SETTING – P

### PROGRAM AE MODE – P

The program AE mode facilitates fast and fully automatic photography. The exposure is controlled by an automatic shutter speed and aperture setting.

- ▶ Select the operating mode **P** (see p. 149)
  - ▶ Tap and hold the shutter button
    - Exposure information is displayed at the bottom of the screen. This contains the automatically set value pair of aperture setting and shutter speed.
    - All other visible displays of the info bars will be hidden.
  - ▶ Shutter release
- or
- ▶ Adjusting the automatically set value pair (Program shift)



## CHANGING THE PRESET SHUTTER SPEED AND APERTURE COMBINATIONS (SHIFT)

Changing the preset values using the Shift function combines the reliability and speed of fully automatic exposure control with the opportunity to vary the speed/aperture combination selected by the camera at any time to fit in with your own ideas and intentions. The overall exposure, i.e. the brightness of the image, remains unchanged. Faster shutter speeds are a good choice for e.g. sports pictures, while longer speeds will offer more depth of field for e.g. landscape pictures.

- ▶ Turn the thumbwheel to the left/right  
(right = greater depth of field with slower shutter speeds, left = faster shutter speeds with lesser depth of field)
  - Shifted value pairs are marked with an asterisk next to the .  
The icon in the top display changes from **P** to **Ps**.

### Note

- The adjustment range is limited to guarantee correct exposure.

## SEMI-AUTOMATIC EXPOSURE SETTING – A/S

### APERTURE-PRIORITY MODE- A

Aperture-priority mode sets the exposure automatically according to the manually selected aperture. This mode is suitable for shots in which the depth of field is a critical compositional element.

By selecting an appropriately low aperture value, you can reduce the depth of field range, for example to make a face “stand out” in sharp focus against an unimportant or distracting background for a portrait. Conversely, you can use a higher aperture value to increase the depth of field range, so that everything from the foreground to the background will be in full focus in a landscape shot.

- ▶ Select the operating mode **A** (see p. 149)
- ▶ Set the desired aperture value
- ▶ Tap and hold the shutter button
  - Exposure information is displayed at the bottom of the screen. This contains the automatically set value pair of aperture setting and shutter speed.
  - All other visible displays of the info bars will be hidden.
- ▶ Shutter release

### Note

- The remaining exposure time after shutter release is counted down in seconds on the display for shutter speeds greater than 2s.



## SHUTTER-PRIORITY MODE – S

Shutter-priority mode will set exposure automatically according to the manually selected shutter speed. It is therefore particularly suitable for pictures of moving objects, where the sharpness of the movement depicted is a critical picture composition element.

An appropriately fast shutter speed can help to avoid e.g. unwanted motion blurring and will “freeze” the object. Conversely, an appropriately longer shutter speed can help create a better feeling of motion in the image with targeted “tracer effects”.

- ▶ Select the operating mode **S** (see p. 149)
- ▶ Set the desired shutter speed
- ▶ Tap and hold the shutter button
  - Exposure information is displayed at the bottom of the screen. This contains the automatically set value pair of aperture setting and shutter speed.
  - All other visible displays of the info bars will be hidden.
- ▶ Shutter release



## MANUAL EXPOSURE SETTING – M

The following manual settings for shutter speed and aperture are a good choice:

- to create a special image mood that can only be achieved with a very specific type of exposure
- to ensure a perfectly identical exposure for multiple images with different cropped sections
- ▶ Select the operating mode **M** (see p. 149)
- ▶ Select desired exposure
  - The exposure compensation is done using the scale of the light balance.
- ▶ Tap and hold the shutter button
  - Exposure information is displayed at the bottom of the screen.
  - All other visible displays of the info bars will be hidden.
- ▶ Shutter release



Displays on the light balance:

	Correct exposure
	Underexposure or overexposure by the displayed value
	Underexposure or overexposure by more than 3 EV (Exposure Value)

## Notes

- The screen image will show an exposure preview if **P-A-S-M** is selected in the menu item **Exposure Preview** (after exposure measuring, see p. 157).
- The shutter-speed dial must be clicked to one of the engraved exposure shutter speeds.

## LONG-TERM EXPOSURE

### FIXED SHUTTER SPEEDS

Your Leica SL3 allows shutter speeds up to 2 minutes in modes **S** and **M** (depending on the selected ISO setting). The remaining exposure time after shutter release is counted down in seconds on the display for shutter speeds greater than 1 s.

#### Via the Control Center

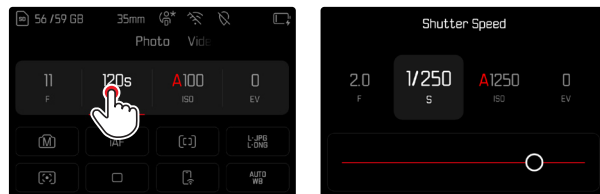

- ▶ Select the operating mode **M** (see p. 149)
- ▶ Select the desired shutter speed (Must be done via fine tuning of the shutter speed, see p. 149)
- ▶ Shutter release

#### Using the dial

Factory setting: Right Dial

(See Assigning functions to control elements, p. xx)

- ▶ Select the operating mode **M** (see p. 149)
- ▶ Turn the right dial
- ▶ Select the desired shutter speed
- ▶ Shutter release

## B FUNCTION

Using the **Bulb** setting in **M** mode will leave the shutter open as long as the shutter button remains pressed (max. 30 min; depending on ISO setting).



- ▶ Select the operating mode **M** (see p. 149)
- ▶ Turn the right dial in clockwise direction until **B** is displayed as the shutter speed

## Notes

- Image noise becomes more apparent when using higher sensitivities, particularly on uniform dark areas. Long exposure times may cause severe image noise. In order to reduce this annoying phenomenon, the camera will take a second “dark frame” (taken with the shutter closed) automatically after a shooting with slow shutter speed and high ISO value. The noise metered in this parallel image is then digitally “subtracted” from the data for the actual image. In such cases the message **Noise reduction in progress...** will appear with a relevant time value. The doubling of the “exposure” time must be taken into account for long-term exposure times. The camera must not be switched off during that time. We recommend disabling Noise Reduction to allow shooting multiple frames in series and to apply noise reduction later during the post-editing stage. The images will have to be taken in raw data format.
- The maximum selectable shutter speed depends, among other things, on the setting of the menu item **Shutter Type**, see p. 147.



## NOISE REDUCTION

Image noise becomes more apparent when using higher sensitivities, particularly on uniform dark areas. Long exposure times may cause severe image noise. In order to reduce this annoying phenomenon, the camera will take a second “dark frame” (taken with the shutter closed) automatically after a shooting with slow shutter speed and high ISO value. The noise metered in this parallel image is then digitally “subtracted” from the data for the actual image. In such cases the message **Noise reduction in progress...** will appear with a relevant time value.

The doubling of the “exposure” time must be taken into account for long-term exposure times. The camera must not be switched off during that time. We recommend disabling Noise Reduction to allow shooting multiple frames in series and to apply noise reduction later during the post-editing stage. The images will have to be taken in raw data format.

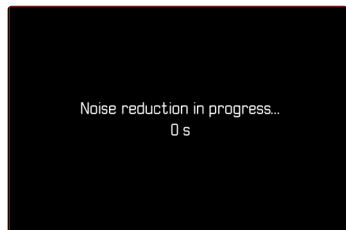

Under certain conditions, noise reduction will always be active as long as the function is enabled. That includes shots taken with the T function, as well as long-term exposure frames with shutter speeds of  $\geq +8$  s.

In all other cases, noise reduction depends on a combination of factors (specifically ISO setting, exposure time, and sensor temperature). The following table contains a list of shutter speeds typical for a sensor temperature of 25°C, at which noise reduction would be applied.

ISO	Shutter speed longer than
100	7 s
200	6.4 s
400	5.9 s
800	5.4 s
1600	4.9 s
3200	4.5 s
6400	4.2 s
$\geq 12\,500$	3.8 s

Noise Reduction can be optionally deactivated (see p. 100).



## EXPOSURE CONTROL

### EXPOSURE PREVIEW

The brightness of the screen image mirrors the effects of the selected exposure settings when pressing and holding the shutter button on the first pressure point. That allows an assessment the effect of the relevant exposure setting on the image before taking the photo. This will apply as long as the subject brightness and the set exposure don't result in excessively low or high brightness values.

This function can be disabled for the manual exposure setting (**M**).

Factory setting: **P-A-S-M**

- ▶ Select **Live View Settings** in the main menu
- ▶ Select **Exposure Preview**
- ▶ Select **P-A-S** (only in program AE, aperture-priority AE and shutter-priority AE mode) or **P-A-S-M** (also for manual setting)

### Notes

- Depending on ambient lighting conditions, the brightness of the screen image may differ from that of the actual images, despite the settings described above. The screen image will appear considerably darker than the – correctly exposed – picture. That is particularly the case in long-term exposures.
- The exposure preview will also be displayed if exposure metering is done via another control element (e.g. using the joystick, provided it was assigned the **AE-L** function).

## EXPOSURE LOCK

We often want to arrange important subject elements outside the center of the image for reasons of pictorial composition and these elements may sometimes be very bright or very dark. Center-weighted metering and spot metering, however, mainly capture an area in the center of the image and are calibrated to an average gray scale value.

In that case, the exposure lock initially allows a metering of the main subject, as well as storing of the relevant settings until the final image section is set. The same applies for focusing (AF-L) in any autofocus mode.

Usually both lock functions (focusing and exposure) are done at the same time with the shutter button. Additionally, you can divide the memory functions between the shutter button and the function button, or assign both to a function button.

The functions include settings and storage.



### AE-L (AUTO EXPOSURE LOCK)

The camera stores the exposure value. The focus can therefore be set on another object, no matter which exposure value is selected.

### AF-L (AUTO FOCUS LOCK)

The camera stores the focus setting. That makes it easier to change the image section when focusing is fixed.

### AE-L/AF-L

With this option enabled, the camera stores the exposure value and the focus setting when the assigned button is pressed and held.

### Notes

- An exposure lock doesn't make much sense in conjunction with multi-field metering, because a targeted capture of an individual object element will not be possible.
- Any previously set exposure lock will be removed by a manual setting of the aperture ring or the shutter-speed dial.

### EXPOSURE LOCK IN AF MODE

The metering functions are distributed as follows while the joystick is pressed and held:

Menu settings	Joystick	Shutter button
AF-L + AE-L	Exposure and focus	No function
AF-L	Sharpness	Exposure
AE-L	Exposure	Sharpness

The shutter button will store both measured values if the joystick is not pressed.

### Via the shutter button

- ▶ Aim at the key part of the object or at a similar detail
- ▶ Tap and hold the shutter button
  - The measurement is taken and saved.
- ▶ Pan the camera to capture the final image section while keeping the shutter button pressed
- ▶ Shutter release

### Via the Joystick

- ▶ Select **Customize Control** in the main menu
- ▶ Select **Joystick**
- ▶ Select **AF Mode**
- ▶ Select the desired setting
- ▶ Press and hold the joystick
  - The measurement is taken and saved.
- ▶ Store more measurements via the shutter button as needed
- ▶ Select the final image section
- ▶ Shutter release

### **EXPOSURE LOCK IN MF MODE**

In MF mode, only the exposure can be locked via the shutter button. This function can also be assigned to the joystick.

The exposure value is saved via the shutter button independent of the setting if the joystick is not pressed.

### Via the shutter button

- ▶ Aim at the key part of the object or at a similar detail
- ▶ Tap and hold the shutter button
  - The measurement is taken and saved.
- ▶ Select the final image section
- ▶ Shutter release

### Via the Joystick

- ▶ Select **Customize Control** in the main menu
- ▶ Select **Joystick**
- ▶ Select **MF Mode**
- ▶ Select **AE-L**
- ▶ Press and hold the joystick
  - The measurement is taken and saved.
- ▶ Select the final image section
- ▶ Shutter release



## EXPOSURE COMPENSATION

Exposure meters are calibrated for a medium gray scale value, which matches a standard, i.e. average image object. Should the measured image detail not fulfill that requirement, then the a relevant exposure compensation can be effected.

Specifically where several shots are taken in sequence, for example if for a series a slightly lesser or greater exposure is desired for a particular reason, then exposure compensation can be a very useful function: Unlike with exposure lock, the setting remains active until it is reset.

Exposure compensation values can be set in the range  $\pm 3$ EV in  $1/3$ EV increments (EV: Exposure Value).



**A** Set compensation value (marks at 0 = Off)

### Using dial controls

This function is assigned to one of the dials in the three (semi) automatic exposure modes, making it easily accessible.

Factory setting: Right Dial

- ▶ Select **Customize Control** in the main menu
- ▶ Select **Dials**
- ▶ Select **Dials (AF lenses)** or **Dials (MF lenses)** depending on the lens used.
- ▶ Selecting the desired dial
- ▶ Select **Exposure Compensation**
- ▶ Use the assigned setting dial to set the desired value

### Via the Control Center

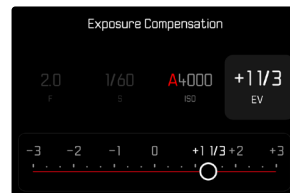
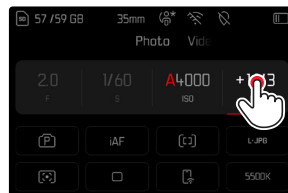





## Notes

- While setting the value, you can see the effect on the screen image, which becomes darker or lighter.
- The following applies for set compensation values, no matter how they were initially set: They remain effective until they are manually reset to 0, even if the camera is switched off and on again in the meantime.
- The set exposure compensation is indicated by a mark on the exposure compensation scale in the footer line.
- Changes to the **EV Increment** setting (see p. 124) lead to the cancellation of a compensation that has been set, i.e. in such cases it is automatically reset to 0.

## DEPTH OF FIELD CHECK

This function simulates the effects of the current aperture and shutter speed settings. It allows the user to assess the exposure and depth of field of the image before shooting. The function is similar to that of the depth-of-field preview button.

- ▶ Assigning the function **Exposure/DOF Simulation** to a function button
- ▶ Press the function button
  - The display cycles through the display options.

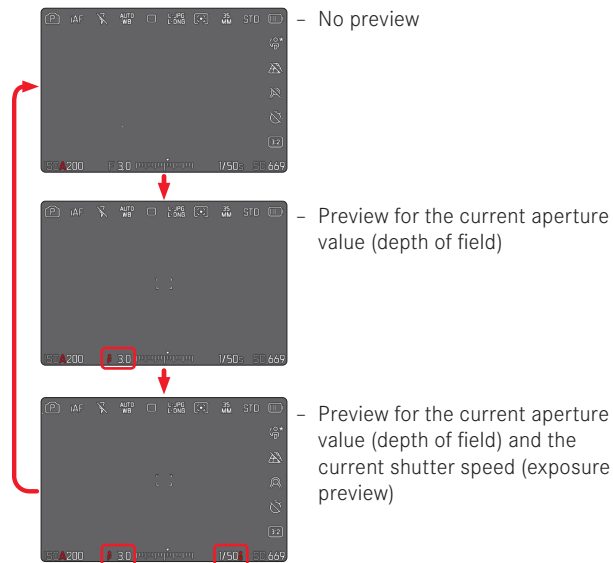



When the exposure information is visible, a green eye symbol  next to the values for aperture and shutter speed will display the active depth of field/exposure preview. The relevant unit of measure icon will additionally appear in green.

## SHOOTING MODES

### CONTINUOUS SHOOTING

The camera is set to single shots by default (**Single**). Series of shots can also be created to e.g. capture motion sequences at various stages.

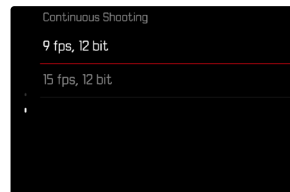
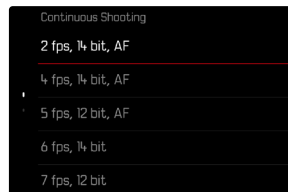

- ▶ Select **Drive Mode** in the main menu
- ▶ Select **Continuous Shooting**
- ▶ Select the desired setting  
(2 fps, 14 bit, AF, 4 fps, 14 bit, AF, 5 fps, 12 bit AF, 6 fps, 14 bit, 7 fps, 12 bit, 9 fps, 12 bit, 15 fps, 12 bit)

Once you have finalized your settings, the camera will do continuous shootings as long as you keep the shutter button pressed down fully (and you have sufficient space on your memory card).



## Notes

- We recommend deactivating the preview mode (**Auto Review**) when using this function.
- Regardless of how many frames were taken in a series, the last image in the series or the last image saved on the memory card while the saving process is ongoing will be displayed first in both review modes.
- Continuous shooting is not possible if a flash is used. Only a single shot will be taken if the flash function is activated.
- Continuous shooting mode is not available in combination with the self-timer function.
- The buffer memory of the camera only allows a limited number of frames in series and in the selected exposure frequency. The exposure frequency is reduced, once the capacity limit of the camera's buffer memory is reached. This slow-down is due to the time required to transfer the data from the buffer memory to the card. The remaining number of exposures is displayed at the bottom right.
- The following applies for continuous shooting with +2 fps to +6 fps:  
Automatic settings (exposure settings in operating modes **P/A/S**, automatic white balance and autofocus) are implemented individually for each frame.
- The following applies for continuous shooting with +7 fps – +15 fps:  
Automatic settings (exposure settings in operating modes **P/A/S**, automatic white balance and autofocus) are implemented for the first frame, and are then applied for each subsequent frame in the same picture series.

## INTERVAL SHOOTING

This camera allows you to automatically capture motion sequences over extended periods of time using the interval shooting function. You specify the number of frames, the intervals between shots, and the start time of the series.

When applying exposure and focus settings, keep in mind that conditions may change during the course of the operation.

- ▶ Select **Drive Mode** in the main menu
- ▶ Select **Interval Shooting**
- ▶ Select **Settings**

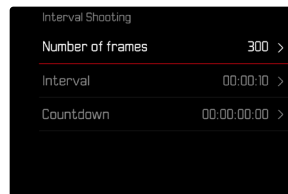

### SPECIFYING THE NUMBER OF FRAMES

- ▶ Select **Number of Frames**
- ▶ Enter the desired value

### SPECIFYING THE INTERVALS BETWEEN SHOTS

- ▶ Select **Interval**
- ▶ Enter the desired value

### SETTING THE DELAY TIME

- ▶ Select **Countdown**
- ▶ Enter the desired value

## Getting started



- ▶ Press the shutter button
  - The LCD panel will switch off automatically between recordings. Tapping the shutter button reactivates the LCD panel.
  - The remaining time until the next shoot and its number is displayed at the top right.

## Cancelling a running series of shots

- ▶ Press the joystick
  - A small menu appears.
- ▶ Select **End**



## Notes

- The use of autofocus in interval shooting may result in not all exposures having their focus on the same object.
- The camera may switch off and on again if “Auto power off” is set and no other camera operation occurs between the individual shots.
- Interval shooting over an extended period of time in a cold location or in a place with high temperature and humidity may result in malfunctions.
- Interval shooting will be interrupted or canceled in the following situations:
  - if the battery is depleted
  - if the camera is switched offMake sure to check the battery for sufficient charge.
- Interrupted or canceled interval shooting can be resumed by switching the camera off, replacing the battery or memory card as needed and then switching the camera back on. A prompt will be displayed on screen if the camera is switched off and on again while the **Interval Shooting** shooting function is active.
- The interval function remains active after the shoot, and also after the camera is switched off and on again, until another shooting mode (Drive Mode) is set.
- Availability of the interval function does not mean that the camera is suitable for use as a monitoring device.
- Regardless of how many frames were taken in a series, the last image in the series or the last image saved on the memory card while the saving process is ongoing will be displayed first in both review modes.
- The shots of an interval shooting are marked with  in review mode.
- The camera may under some circumstances be unable to take good pictures. That may happen if, for example, focusing was

unsuccessful. In that case, the camera will not take a picture and the series will continue with the next interval. The message **Some Frames are dropped** appears on screen.

## EXPOSURE BRACKETING

Many attractive objects are rich in contrast, which means they have very bright and very dark areas. The image effect can be dramatically different, depending on which of these areas you choose to align your exposure with. The automatic bracketing function in aperture-priority mode allows you to produce several alternatives with graduated exposure values and varying shutter speeds. You can then select the image you like best or use relevant photo editing software to calculate an image with a particularly broad contrast spectrum (HDR).

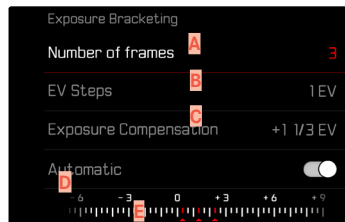

- A** Number of frames
- B** Exposure difference between shots
- C** Exposure compensation
- D** Light value scale
- E** Exposure values of the images marked in red (The scale will be offset by the relevant value if exposure compensation is set concurrently.)



You can select the desired number of frames (3 or 5). The exposure difference, which can be set via **EV Steps**, can be up to 3EV.

- ▶ Select **Drive Mode** in the main menu
- ▶ Select **Exposure Bracketing**
- ▶ Select **Settings**
- ▶ Select the desired number of frames under **Number of Frames** in the submenu
- ▶ Select the desired exposure offset under **EV Steps** in the submenu
- ▶ Select the desired **Exposure Compensation** value in the submenu
  - The marked exposure values change positions according to the settings selected. In the case of exposure compensation, the scale also shifts.
  - The selected exposure compensation value will be applied to the entire series of shots.
- ▶ Select the desired setting under **Automatic** in the submenu
  - With the factory setting in place (**On**), the entire exposure series will run after the shutter button is pressed once; when the setting is **Off**, each picture must be taken individually.
- ▶ Take one or several shots by pressing the shutter button

## Notes

-  appears on the LCD panel if the bracketing function is activated. You can watch the effect of the function on screen during shooting (brighter or darker).
- Depending on the exposure mode, the exposure gradations are produced by changing the shutter speed and/or aperture value:
  - Shutter speed (**A/M**)
  - Aperture (**S**)
  - Shutter speed and aperture value (**P**)
- The sequence of shots: underexposure/correct exposure/overexposure.
- The working range for automatic bracketing may be limited depending on the available shutter speed/aperture combination.
- With automatic ISO sensitivity control enabled, the sensitivity calculated by the camera automatically for the raw files will also be applied to all other shots in the series, i.e. the ISO value will not change during bracketing. This may mean that the slowest shutter speed specified under **Shutter Speed Limit** is exceeded.
- The working range for automatic bracketing may be limited (depending on the originally set shutter speed). The specified numbers of frames will be taken regardless. Several shots in a series may consequently have the same exposure values.
- The function remains active until another function is selected from the **Drive Mode** submenu. If no other function is selected, another bracketing is taken each time the shutter button is pressed.

## SELF-TIMER

The self-timer function allows shoot with a preset time delay. We recommend that the camera is placed on a tripod.



- ▶ Select **Self-timer** in the main menu
- ▶ Select **Settings**
- ▶ Select the desired setting  
(**Self-timer 2 s**, **Self-timer 6 s**, **Self-timer 12 s**, **Self-timer 30 s**)
- ▶ Shutter release
  - The remaining time until exposure is counted down on the LCD panel. The self-timer LED at the front of the camera counts down the delay time. It flashes slowly during the first 10 s, then fast for the last 2 s.
  - The self-timer delay time can be canceled at any time by tapping the shutter button; the relevant settings remain intact.

## Notes

- Exposure metering is done first; in autofocus mode, focusing is first. Only then will the delay time commence.
- The self-timer function is available only for single frame shooting and for bracketing.
- The function remains active until another function is selected from the **Self-timer** submenu.





## SPECIAL SHOOTING MODES

### PERSPECTIVE CONTROL

This assist function displays a frame showing the expected cropped section of the image after a correction of the perspective of vertical falling lines. Perspective Control helps to achieve a generally straighter vertical line and straight horizon, which ensures a natural image effect, specifically in architectural images.

The function “Perspective Control” calculates the image section and the required distortion correction based on the actual panning angles of the camera and the lens used. In effect, the camera orientation during shooting (determined by internal camera sensors) is the decisive factor and not the lines visible in the image object. The function is therefore unlike automatic perspective control features used for post-editing, which are generally based on the image content.

The functionality depends on the image file format used (JPG or DNG). For JPG format images, the correction occurs directly in the camera and the corrected image is stored. For DNG format images, the relevant information is written to the meta data of the original image. Image correction is done later on using a program like Adobe Photoshop Lightroom® or Adobe Photoshop®\*.

Factory setting: **Off**

### Notes

- In case of large panning angles, the distortion correction needed for a complete perspective control would be too extreme. That is why this function is automatically skipped or only partially used where angles are too large. In that case, we recommend creating DNG format images and effecting the desired corrections in a post-editing step.
- A histogram will not be available for technical reasons, while the function **Perspective Control** is active.

---

\* See p. 146 for more information.



This function can only be used in Live View mode.

- ▶ You may have to activate Live View
- ▶ Select **Perspective Control** in the main menu
- ▶ Select **On**



## ACTIVE PERSPECTIVE CONTROL



## DETECTED PERSPECTIVE IN LIVE VIEW MODE



## CORRECTED PERSPECTIVE IN REVIEW MODE





## JPG FORMAT IMAGES

For JPG format images, the correction occurs directly in the camera and only the corrected image is stored. Any image content outside the frame will be lost.

## DNG FORMAT IMAGES

In DNG format, the entire sensor image is stored unchanged. The data calculated by Perspective Control is written to the meta data of the image. Image correction is done later, using appropriate software like Adobe Photoshop Lightroom® or Adobe Photoshop®\*. A corrected preview version of the image (thumbnail) is displayed in review mode. The same applies for automatic review directly after the image is taken.

However, when opening the file in Adobe Photoshop Lightroom® or Adobe Photoshop®, the original image will be displayed. Depending on the default settings of the software, the image can also be directly displayed with the corrections from the auxiliary frame.

## PERSPECTIVE CONTROL IN ADOBE LIGHTROOM® AND ADOBE PHOTOSHOP®

Perspective Control can be done as part of the post-editing process for DNG format images using e.g. Adobe Photoshop Lightroom® or Adobe Photoshop®. Read the Adobe Online Help for more detailed information about the topic.

### ADOBE LIGHTROOM®:

<https://helpx.adobe.com/en/lightroom-classic/help/guided-up-right-perspective-correction.html>

### ADOBE PHOTOSHOP®:

<https://helpx.adobe.com/en/photoshop/using/perspective-warp.html>

## CORRECTION AND DISPLAY OF AUXILIARY LINES

Select the function “With auxiliary lines” under “Geometry” > “Upright” to apply the correction defaults of the camera and display the auxiliary lines.

Correction will automatically applied if the RAW default setting “Camera Settings” is selected.

Correction can be disabled under “Upright” at any time.

<https://helpx.adobe.com/en/photoshop/kb/acr-raw-defaults.html>

- ▶ Select “Camera Settings” as the RAW default setting





## Browsing through the images

- ▶ Press the joystick left/right

or

- ▶ Turn the thumbwheel

or

- ▶ Swipe to the left or right

## Selecting a recorded image

- ▶ Press the joystick/thumbwheel

or

- ▶ Directly select the control element “Confirm”

## Resetting the function when switching off the camera

The function settings can optionally be reset when switching off the camera.

- ▶ Select **Image Overlay** in the main menu

- ▶ Select **Reset on Turn Off**

- ▶ Select **On**

- The image selection and the setting for **Use Image Overlay** will remain intact after the camera is switched off if **Off** is selected.

## ACTIVATING THE FUNCTION

- ▶ Select **Image Overlay** in the main menu

- ▶ Select **Use Image Overlay**

- ▶ Select **On**

## FLASH PHOTOGRAPHY

The camera determines the necessary flash intensity by firing one or more pre-flashes before taking the actual photo. The main flash fires immediately after, i.e. during exposure. All factors influencing exposure (e.g. filters, aperture settings, distance to the main subject, reflective ceilings, etc.) are automatically considered.

### COMPATIBLE FLASH UNITS

The full functional scope described in this instruction manual, including TTL flash exposure is available only in conjunction with Leica system flash units like the SF 40, or devices by Profoto. Other flash units, which only have a positive center contact, can be safely fired via the Leica SL3, but cannot be controlled via the camera. Correct function cannot be guaranteed when using any other flash unit.

#### Note

- When using flash units that are not specifically designed for the camera and can therefore not automatically switch over the white balance of the camera should be used in the WB flash setting.

#### Important

- The use of incompatible flash units with your Leica SL3 may result in irreparable damage to the camera and/or the flash unit.

#### Notes

- A flash unit that is not ready to flash may cause incorrect exposures or error messages.
- Studio flash systems may have a very long flash firing duration. It may therefore be advantageous to select a slower shutter speed than 1/200s when using such a system. The same applies for RF-controlled flash firing for so-called “off-camera” flashes, as the transmission time may cause a delay.
- Serial exposures and automatic bracketing with flash are not available.
- Use a tripod to prevent blurring at slow shutter speeds. Alternatively, you can select a higher sensitivity.





## ATTACHING THE FLASH UNIT

- ▶ Switch off the camera and flash unit
- ▶ Pull off the accessory shoe cover and store it in a safe place
- ▶ Slide the foot of the flash unit all the way into the accessory shoe and use the clamping nut (where available) to secure it against accidental movement
  - Movement inside the accessory shoe can interrupt required contacts and therefore cause malfunctions.

## DETACHING THE FLASH UNIT

- ▶ Switch off the camera and flash unit
- ▶ Release the lock as needed
- ▶ Detach the flash unit
- ▶ Replace the accessory shoe cover

### Note

- Make sure that the accessory shoe cover is always in place when no accessory is attached (e.g. a flash unit).

## FLASH EXPOSURE METERING (TTL METERING)

In conjunction with system-compatible flash units (see p. 173), the camera offers a fully automated flash mode, which is also available in the exposure modes Aperture-Priority and Manual.

In aperture-priority mode and with manual setting, the camera furthermore allows the use of other interesting flash techniques like flash synchronization and firing with slower shutter speeds than the max. sync time.

The camera additionally communicates the sensitivity setting to the flash unit. The flash unit can use this information to automatically adjust its range data, provided the device comes with these displays and the aperture setting selected on the lens is also entered manually on the flash unit. The ISO sensitivity setting cannot be altered via the flash unit on system-compatible units, because the information is received from the camera.

## SETTINGS ON THE FLASH UNIT

Operating mode	
<b>TTL</b>	Automatic control by the camera
<b>A</b>	SF 40, SF 60: Automatic camera control, no flash exposure compensation  SF 58, SF 64: Control via the flash unit using a built-in exposure sensor
<b>M</b>	The flash exposure must be set to an output level to match the aperture and shutter speed settings determined by the camera.

### Notes

- Set the flash unit to **TTL** mode to allow automatic control of the unit by the camera.
- When set to **A**, objects with above or below average brightness may not be exposed correctly.
- Please read the relevant manual provided with third party flash units regarding their various operating modes.

## FLASH MODES

Select one of the three available operating modes.

- Automatic
- Manual
- Long-term exposure

### **AUTOMATIC FLASH ACTIVATION**

That is the default flash mode. The flash unit will fire automatically if poor lighting conditions would mean slower shutter speeds, which could result in blurred images.

### **MANUAL FLASH ACTIVATION**

This mode is suitable for backlit pictures in which the main subject does not fill the entire frame and is in shadow, or in situations where a fill-in flash will moderate sharp contrasts (e.g. in direct sunlight). The flash will fire each time a picture is taken, regardless of prevailing lighting conditions. The flash intensity depends on the metered ambient brightness: in poor light it is the same output as in automatic mode, with output decreasing with increasing brightness. The flash will then work as a fill-in light, e.g. to light up dark shadows in the foreground or backlit objects, and to create more balanced overall lighting.





## ⚡Ⓢ AUTOMATIC FLASH ACTIVATION AT SLOWER SHUTTER SPEEDS (LONG-TERM SYNCHRONIZATION)

This mode ensures appropriately exposed, brighter dark backgrounds and bright foreground.

The shutter speed is not extended beyond 1/30 s in the other flash modes to minimize the risk of blurring. This may mean, however, that pictures with flash exposure can end up with objects in the background not illuminated by the flash and therefore being underexposed. In this mode, slower shutter speeds (up to 30 s) are permitted to avoid this effect.

- ▶ Select **Flash Settings** in the main menu
- ▶ Select **Flash Mode**
- ▶ Select the desired setting
  - The currently active mode is displayed on screen.



## FLASH CONTROL

The settings and functions described in the following sections only apply to settings and functions available in this camera and in system-compatible flash units.

### SYNC POINT

Flash exposures are lit by two light sources:

- existing light from the environment
- the additional flash

Any subject elements lit primarily by the flash will almost always be rendered in perfect focus by the short burst of light, provided the focus is set correctly. All other subject elements in the same frame lit by ambient light or lit from within will be rendered with varying degrees of sharpness. Whether or not these object elements will be rendered in sharp focus or blurred, as well as the degree of “blurriness” depends on two interdependent factors:

- the shutter speeds
- the speed of movement of the subject elements or camera during shooting

The longer the shutter speed and the faster the motion, the greater the difference between the two superimposed partial images.





A flash is usually fired at the start of exposure (**Start of Exposure**). This may result in apparent contradictions, e.g. the image of a vehicle being overtaken by its own light trail. This camera alternatively allows synching with the end of exposure (**End of Exposure**). The sharp image will in this case be a rendering of the end of the captured motion. This flash technique creates a more natural impression of movement and dynamics in the image.

This function is available with all camera and flash unit settings.

Factory setting: **End**

- ▶ Select **Flash Settings** in the main menu
- ▶ Select **Flash Sync**
- ▶ Select the desired setting (**Start**, **End**)
  - The set sync point is shown in the header line.

## Notes

- Do not use sync cables that are longer than 3m.
- When using the flash with faster shutter speeds, a difference between the two flash firing points will be barely discernible or only noticeable for very fast movements.

## FLASH RANGE

The usable flash range depends on the aperture and sensitivity values set manually or calculated by the camera. It is important to ensure that the subject is within the relevant flash range for sufficient illumination. A permanent setting to the shortest available shutter speed for flash mode (sync time) may often result in unnecessary underexposure of those subject elements that are not lit sufficiently by the flash.

This camera allows the fine tuning of the shutter speed used in flash mode in combination with aperture-priority mode depending on the conditions of the object or your own pictorial composition ideas.

Factory setting: **Auto**

- ▶ Select **ISO Settings** in the main menu
- ▶ Select **Auto ISO Settings**
- ▶ Select **Shutter Speed Limit (Flash)**
- ▶ Select the desired value

## Note

- The menu item **Shutter Speed Limit (Flash)** in submenu **Flash Settings** is identical to the menu item of the same name in submenu **Auto ISO Settings**. A setting in one menu will affect the other.

## FLASH EXPOSURE COMPENSATION

This function can be used to selectively reduce or enhance flash exposure regardless of ambient light, e.g. to brighten the face of a person in the foreground when taking a photo outdoors in the evening while retaining the same general lighting mood.

Factory setting: 0 EV

- ▶ Select **Flash Settings** in the main menu
- ▶ Select **Flash Exp. Compensation**
  - The submenu displays a scale with a red setting mark. The function is deactivated if the value is set to 0.
- ▶ Set the value on the scale
  - The set value is displayed above the scale.

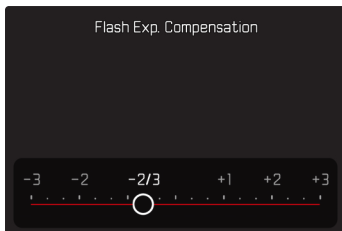

## Notes

- The following applies for set compensation values, no matter how they were initially set: They remain effective until they are manually reset to 0, even if the camera is switched off and on again in the meantime.
- The menu item **Flash Exp. Compensation** can only be used in conjunction with flash units on which the compensation value cannot be set manually (e.g. Leica SF 26).
- **Flash Exp. Compensation** is unavailable, if flash units with an own compensation function are used (e.g. Leica SF 58 or Leica SF 60). A compensation value set on the camera would in that case have no effect.
- A brighter flash illumination with Plus compensation will require a greater flash intensity. Flash exposure compensation will therefore impact on the flash range: A Plus correction will decrease it, a Minus correction will increase it.
- An exposure compensation set on the camera will only affect the measurement of ambient light. If a simultaneous TTL flash exposure metering compensation is desired in flash mode, then it must be additionally set on the flash unit.



## FLASH PHOTOGRAPHY

- ▶ Switch on the flash unit
- ▶ Set the desired guide number control mode (e.g. TTL or GNC = Guide Number Control) on the flash unit
- ▶ Switch the camera on
- ▶ Set the desired exposure mode, shutter speed and/or aperture setting
  - It is imperative to take note of the shortest flash sync speed, as it determines whether a “normal” flash or an HSS flash is fired.
- ▶ Tap the shutter button before each flash exposure to activate exposure metering
  - The flash unit may not fire if this step is missed by pressing the shutter button down completely and skipping these settings.

### Note

- It is recommended to use a different exposure metering method than **Spot** in flash photography.



## REVIEW MODE

There are two completely independent review functions available:

- short-term rendering directly after shooting (**Auto Review**)
- normal review mode, in which the stored images can be viewed and managed for any length of time

The switchover between shooting and review mode, as well as most other actions can be completed using gesture or key control. Please see p. 61 for more information about the available gestures.

### Notes

- Recorded images are not automatically rotated in review mode to utilize the full screen area.
- It may not be possible to render files with this camera that were not recorded with this device.
- In some cases, the screen image may not have the expected quality, or the LCD panel will remain blank and only display the file name.
- You can toggle back from review mode to shooting mode at any time by tapping the shutter button.
- The histogram and clipping displays are available only when viewing the full size picture, but not during zooming or in the overview.

## CONTROL ELEMENTS IN REVIEW MODE

### CONTROL ELEMENTS ON THE CAMERA

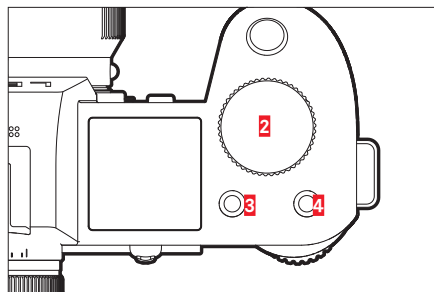
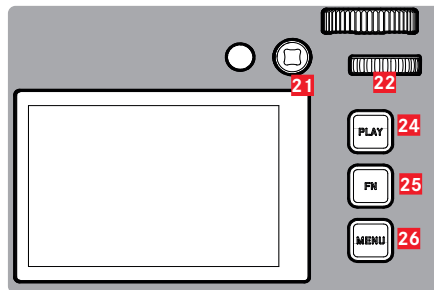

- |                          |                                      |
|--------------------------|--------------------------------------|
| <b>2</b> Right dial      | <b>22</b> Thumbwheel (turn or press) |
| <b>3</b> Function button | <b>24</b> <b>PLAY</b> button         |
| <b>4</b> Function button | <b>25</b> <b>FN</b> button           |
| <b>21</b> Joystick       | <b>26</b> <b>MENU</b> button         |

## DIRECT ACCESS IN PLAYBACK MODE

The function buttons can have individual assignments in review mode as well.

In factory settings, the function buttons have the following assignments:

Button	Function
Right dial	Magnification
Function button <b>3</b>	Delete Single
Function button <b>4</b>	Mark shots (Rate / Unrate)
FN button	Toggle Info Levels

The descriptions in the next few sections presume factory settings.

### Note

- The assigned function is independent of the current display mode; the delete functions overview can therefore be accessed directly in full screen display mode.
- The assigned function is unavailable if the function button addresses an on-screen control element (e.g. in the “Delete” screen).

## CONTROL ELEMENTS ON THE LCD PANEL

On-screen control elements generally function by intuitively by touch. Many can also be selected by pressing one of the three buttons to the right of the LCD panel (**PLAY** button, center button, **MENU** button). A control element in the header is accompanied by an icon denoting the relevant button. A control element on the edge of the screen will be positioned directly next to the relevant button.

You have e.g. two options to select the Favorites icon ★:

- Tap on the Favorites icon directly
- Press the relevant button  
(Factory setting: Function button **4**)

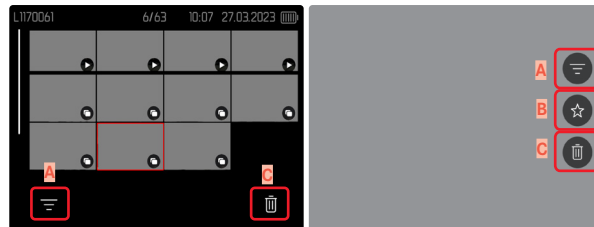

- A** Control element “Filter”
- B** Control element “Favorites”
- C** Control element “Delete”

## STARTING/EXITING REVIEW MODE

### Using touch control

- ▶ Swipe down

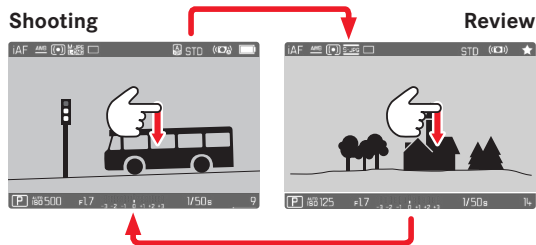

### Using button control

- ▶ Press the **PLAY** button
  - The last image taken appears on the screen.
  - The following message appears if the inserted memory card does not contain any image data: **No valid picture to play.**
  - The **PLAY** button function differs, depending on the current camera setting

Initial situation	After pressing the PLAY button
Full screen display of an image	Shooting mode
Display of an enlarged cropped section/or several thumbnails	Full screen display of the image

## SELECTING/SCROLLING THROUGH IMAGES

The images are visually arranged in a horizontal reel. The sorting will be strictly chronological. When the end of an image series is reached, the display automatically jumps back to the first image in the series. All images can therefore be reached by scrolling either right or left.

### SINGLE

#### Using touch control

- ▶ Swipe to the left or right

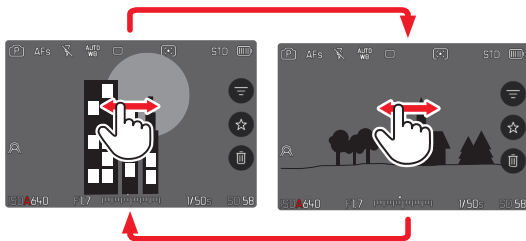

#### Using button control

- ▶ Press the joystick left/right
- or
- ▶ Turn the thumbwheel

## CONTINUOUS

- ▶ Swipe to the left or right and hold the finger on the edge of the screen
  - The subsequent shots will move past continuously.





## STORAGE LOCATIONS

Leica SL3 offers with two separate storage locations.

When review mode is accessed, the last captured image will always be displayed first. That also applies on the storage location displayed first.

When scrolling through images and also in the overview, the images saved to the same storage location are available first.

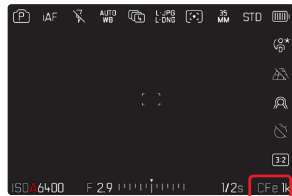

### Switching the displayed storage location

- ▶ Reduce the view as much as possible (see p. 79)
  - The storage location selection view appears.
  - The currently selected storage location is displayed with a color fill.

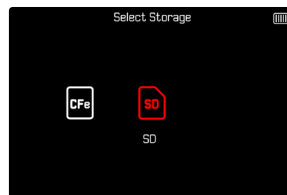

- ▶ Press the directional pad left/right
  - The newly selected storage location appears with a color frame.
- ▶ Press the center button
- ▶ Re-enlarge the view



## INFO DISPLAYS IN REVIEW MODE

The same info profiles are available in playback mode as in shooting mode. The actual info profile currently in use, however, is saved separately. It is therefore possible to use an empty info profile completely without assist function icons in review mode, without having to set them again when switching to shooting mode. See p. 115 for setting options and additional information. The assist functions **Grid** and **Level Gauge** are not available in review mode.

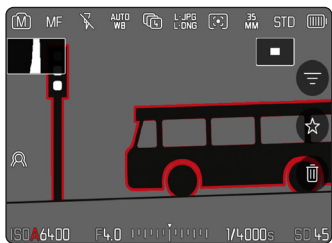

### Switching between info profiles

- ▶ Press the **FN** button
  - The info bars appear (header and footer line always appear/disappear together in review mode).
  - The displays for **Histogram** and **Clipping** will appear if these functions are activated.

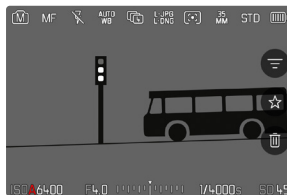

Info Bars

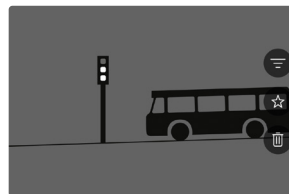

Empty info profile

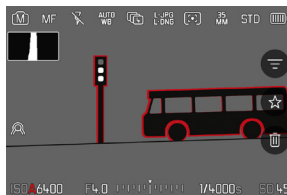

Info Bars, Focus Peaking,  
Histogram

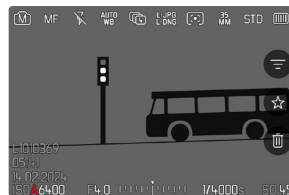

Info Bars, file information



## PICTURE SERIES REVIEW

Serial and interval shootings often produce a large number of individual images. It would be very difficult to find other pictures that are not part of a series if every image of all these series was displayed individually. Organizing the images in groups creates more clarity in review mode.

Factory setting: **Off**

- ▶ Select **Group Display Mode** in the main menu
- ▶ Select **On**

All images in all series are displayed individually if **Off** is selected. The images are grouped in series and only one representative image will be displayed if **On** is selected. Only that one representative image will be displayed and all other images in that series are hidden during scrolling.



The representative image is shown with **▶** in the center and **5/8** at the bottom left.

There are two options for viewing the images in a group: manual scrolling or automatic playback. Automatic review is the default setting.

## UNINTERRUPTED PLAYBACK OF THE PICTURE SERIES

The images in a group can be played back from start to finish without interruption. This may be very helpful to get a better idea of the processes or conditions rendered than if the images were scrolled manually.

- ▶ Tap **▶**

or

- ▶ Press the joystick/thumbwheel
  - Auto Review commences.

## PAUSE PLAYBACK

- ▶ Tap anywhere on the LCD panel

or

- ▶ Press the joystick/thumbwheel
  - Playback stops, the current picture in the series is displayed.

## RESUMING PLAYBACK

While the control elements are visible:

- ▶ Tap anywhere on the LCD panel

or

- ▶ Press the joystick/thumbwheel

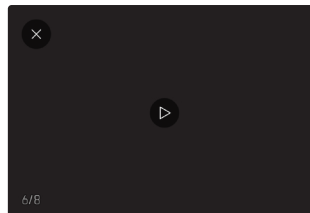

## SAVE AS A VIDEO

The frame series can additionally be saved as a video.

- ▶ Starting and stopping review
- ▶ Press the **MENU** button
- ▶ Select **Yes/No**
  - **Yes**: A video is created
    - A progress screen for the video creation is displayed briefly (while the data is being processed). It also offers the option of canceling the process by pressing the center button.
    - Once video creation is complete, the first frame of the new video is displayed.
  - **No**: Revert to the same picture of the (still paused) automatic review

## SCROLLING THROUGH THE INDIVIDUAL PICTURES OF A SERIES

The images in a picture series can also be viewed individually. Switch to the manual scrolling function to do so.

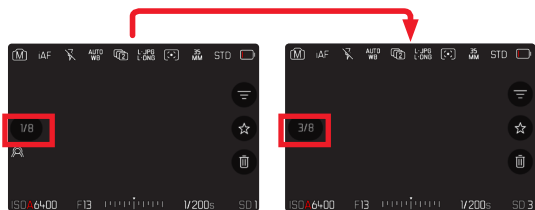



- ▶ Press the joystick up/down
    - The information displays disappear in full-screen mode.
    - Active information displays appear at the bottom left of the image.
  - ▶ Press the joystick left/right
- or
- ▶ Swipe left

### Returning to standard review mode

- ▶ Press the joystick up/down

### Notes

- The review will be limited to the current picture series while you are scrolling in that series. The same applies for the overview with 9 or 16 thumbnails.
- The images of a series are marked with  in the header line, those of an **Interval Shooting** shoot by a .



## CROPPED SECTION ZOOM

You can zoom in to any section of an image for closer inspection. You have a five-step zoom factor available via the thumbwheel, while zooming is stepless if you use touch control.

### Using touch control

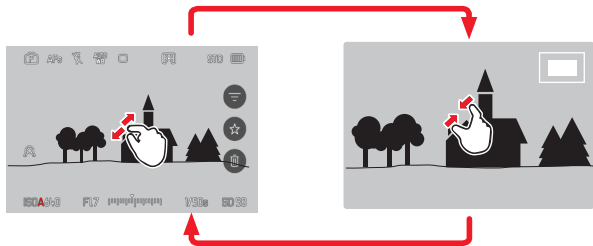

- ▶ Two-finger pinch/spread
  - The image will be zoomed in/zoomed out at the desired point.



- ▶ Move the position of an enlarged cropped section by swiping
  - The rectangle within the frame at the top right represents the current magnification, as well as its position in the displayed cropped section.

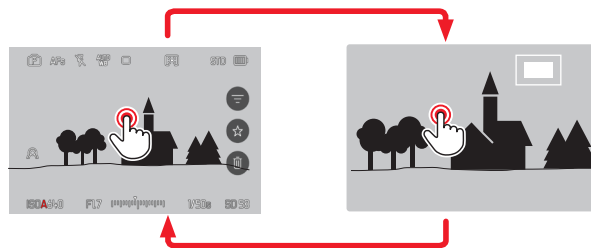

- ▶ Double tap
  - Toggles between the third zoom increment at the tap position and standard full screen view.

### Using button control

- ▶ Turn the right dial  
(in clockwise direction: increase magnification, anti-clockwise: decrease magnification)

or

- ▶ Press the joystick/thumbwheel
  - Toggles between the third zoom increment at the tap position and standard full screen view.
- ▶ Use the joystick to move the position of the cropped section while the image is magnified
  - The rectangle within the frame at the top right represents the current magnification, as well as its position in the displayed cropped section.

You can move directly from one image to the next in magnification mode, which will then also be displayed with the same magnification.

- ▶ Turn the thumbwheel to the left/right

### Notes

- It may not be possible to enlarge images taken with other camera types.
- Video recordings cannot be enlarged.

## DISPLAYING MULTIPLE IMAGES AT ONCE

The camera offers an overview function in which several thumbnail images can be viewed on one screen, which makes it easier to find a specific image. Choose to display 9 or 16 thumbnails for your overview.

### OVERVIEW

#### Using touch control

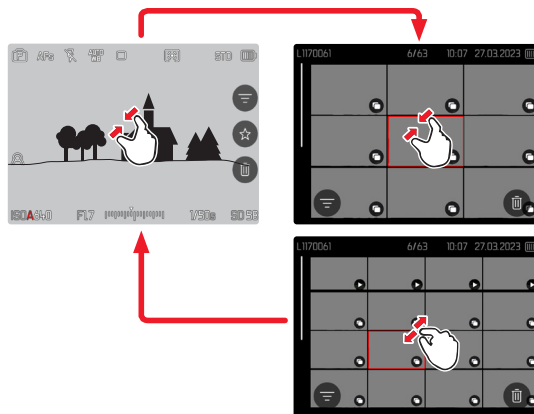

- ▶ Two-finger pinch
  - The display toggles between 9 or 16 thumbnails.

#### Viewing other images

- ▶ Swipe up or down



## Using button control

- ▶ Turn the right dial in anti-clockwise direction
  - An overview with 9 thumbnails is displayed. Another turn on the dial increases the number of displayed thumbnails to 16.

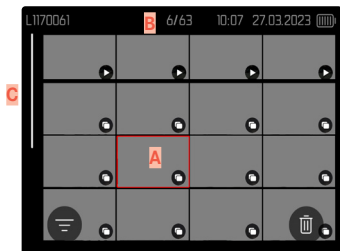
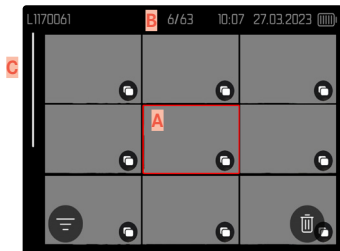

- A** Currently selected image
- B** Number of the currently selected images
- C** Scrollbar

The currently viewed image is framed in red and can be selected for a closer look.

## Navigating between images

- ▶ Press the joystick in the relevant direction
- or
- ▶ Turn the thumbwheel

## Displaying the image in full size

### Using touch control

- ▶ Two-finger spread
- or
- ▶ Tap the desired image

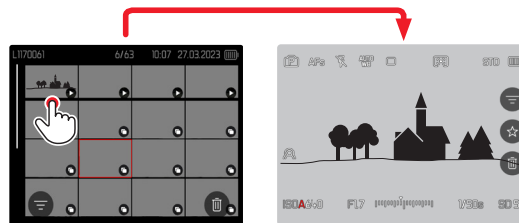

### Using button control

- ▶ Turn the right dial in clockwise direction
- or
- ▶ Press joystick, thumbwheel or **PLAY** button

## TAGGING/RATING OF IMAGES

Images can be marked as favorites to find them quicker or to simplify the later deletion of multiple images. Tagging can be done in regular view mode or in the overviews.

### Tagging a recording

- ▶ Press the function button **4**

or

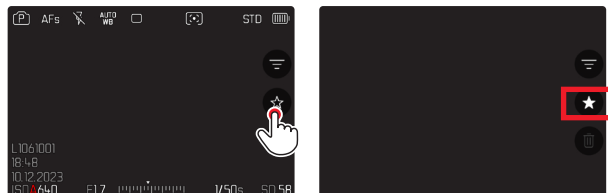

- ▶ Tap the ★ icon
  - The ★ icon is highlighted.
  - The icon will appear in the header on the far right when viewing images in full size, and in the lower left corner of the thumbnail overview.

### Removing a tag

- ▶ Press the function button **(i4)**

or

- ▶ Tap the ★ icon

## DELETING IMAGES

There are several methods available to delete images:

- deleting individual images
- deleting multiple images
- deleting all images without a icon/ranking
- deleting all images



### Important

- Once deleted, images are no longer retrievable.



## DELETING INDIVIDUAL IMAGES



- ▶ Tap the Delete  icon
  - A confirmation prompt appears.
  - The LED will flash during the delete process. The process may take a few seconds.
  - The next image will be displayed once deletion is complete. The following message appears if no other images are saved on the card: `No valid picture to play`.

or

- ▶ Press the function button 
  - The Delete screen appears.

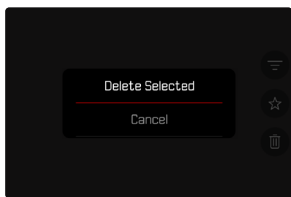

## Cancelling a deletion and returning to normal review mode

- ▶ Press the **PLAY** button

### Notes

- The Delete screen can be called up only by pressing the **MENU** button when in overview mode, because the menu function `De-lete` of the “Play menu” is not available in this context.



## DELETING MULTIPLE IMAGES

You can highlight multiple images in a Delete overview with twelve thumbnails for simultaneous deletion.

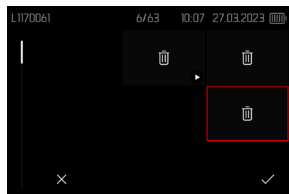

- ▶ Turn the right dial to the left
  - The overview screen appears.
- ▶ Press the **MENU** button
- ▶ Select **Delete Multi**
  - The Delete overview appears.

Any number of images can be selected in this view.

### Selecting images for deletion

- ▶ Select an image
  - ▶ Press the joystick/thumbwheel
- or
- ▶ Tap the desired image
    - The images selected for deletion are marked with a red Delete icon .

### Deleting the selected images

- ▶ Press the **MENU** button

or

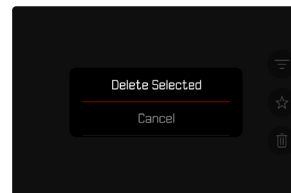
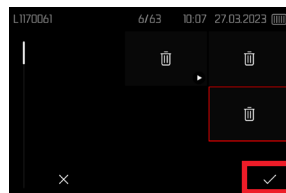

- ▶ Tap the “Confirm” icon
- ▶ Select **Delete Selected**
  - The images selected for deletion are marked with a red Delete icon .

### Cancelling a deletion and returning to normal review mode

- ▶ Press the **MENU** button





## DELETING ALL UNRATED IMAGES

- ▶ Press the **MENU** button
- ▶ Select **Delete All without ★**

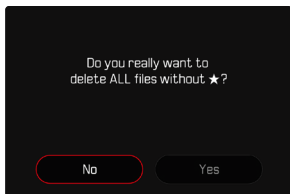
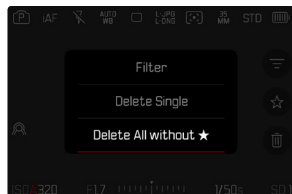

- The confirmation prompt **Do you really want to delete ALL files without ★?** appears.
- ▶ Select **Yes**
- The LED will flash during the deletion process. The process may take a few seconds. The next marked image appears once deletion is complete. The message **No valid picture to play** appears if no other images are saved on the card.

## DELETING PICTURE SERIES

Picture series can be displayed in groups for quick deletion. The pictures will have to be displayed in groups.

- ▶ Select **Play Mode Setup** in the main menu
- ▶ Select **Group display mode**
- ▶ Select **On**

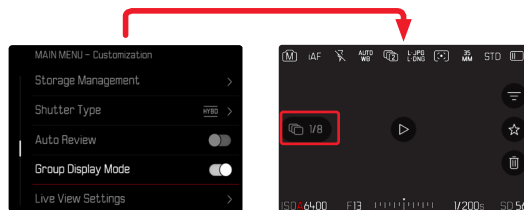

- ▶ Select the representative image

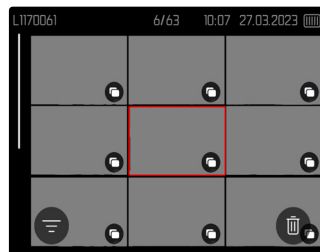

- ▶ Delete
  - All pictures in the picture series will be deleted.



## PREVIEW OF LATEST IMAGE

Photos can be displayed automatically directly after they are taken to e.g. check the success of the shots quickly and easily. A duration for the automatic display can be configured.

- ▶ Select **Auto Review** in the main menu
- ▶ Select **Setting**
- ▶ Select the desired function or duration in the submenu  
(1 s, 3 s, 5 s, Permanent, Shutter Button Pressed)

**Permanent:** The most recent frame is displayed until automatic review is ended by pressing the **PLAY** button or by tapping the shutter button.

**Shutter Button Pressed:** The most recent frame is displayed for as long as the shutter button is pressed down.

### Notes

- Various control elements change back to regular review mode to execute their normal functions while automatic review is selected. The camera will remain in review mode until it is exited.
- Marking and deleting can only be done in regular review mode and not during automatic review.
- When shooting with the Continuous Shooting or Interval Shooting functions, then the last image in the series will be displayed or – if the save process is still incomplete – the last image in the series saved to the memory card.
- Where display times were configured (1 s, 3 s, 5 s) automatic review can be ended immediately by pressing the **PLAY** button or tapping the shutter button.



## VIDEO SETTINGS

### SENSOR FORMAT

The image data of the entire 35 mm sensor can be used or only that of a cropped section, which corresponds to the APS-C format. This can be helpful, e.g. when only limited storage capacity remains or a lens developed specifically for APS-C is used.

Factory setting: 35 mm

- ▶ Select **Sensor Format** in the main menu
- ▶ Select the desired setting  
(35 mm, APS-C)

#### Note

- The setting switches automatically to APS-C when an APS-C-specific lens is mounted.

### FILE FORMAT

Video can be recorded in the file formats MOV or MP4.

Various combinations of resolution and frame rate can be configured depending on the file format chosen. The settings are done separately. You could therefore select the combination **C4K/29.97 fps** for the MOV format or **FHD/59.94 fps** for MP4. The preset video format settings are then accessed automatically, when one of the two file formats is selected.

#### Note

- You can toggle between video file formats via the Control Center without having to (re)configure any settings.

## VIDEO FORMAT

The following combinations of resolution and frame rate are available: See the chapter “Technical Data” for a comprehensive list of all available combinations.

## SETTING THE VIDEO FORMAT

Via the Control Center



About the menu

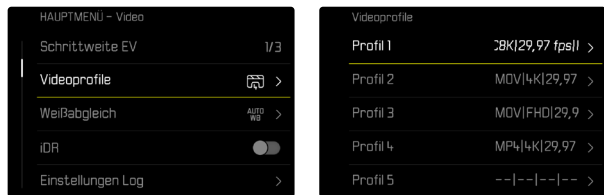

- ▶ Select **Video Profiles** in the main menu
- ▶ Select a profile

## Profile editing

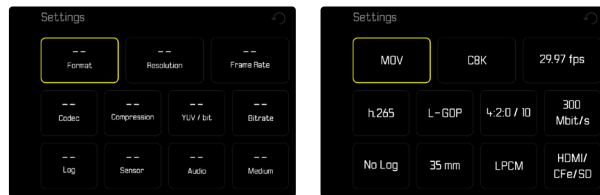

- ▶ Select **Video Profiles** in the main menu
- ▶ Select a profile
- ▶ Select a format  
(MOV, MP4)
- ▶ Select the desired resolution  
(MOV: C8K, 8K, C4K, 4K, FHD, FHD Slow Motion)  
(MP4: 8K, 4K, FHD)
  - Some fields are prepopulated automatically.
- ▶ Select the desired frame rate
  - Some fields are prepopulated automatically.
- ▶ Choose the desired sensor size  
(35 mm, APS-C)
- ▶ Choose the desired output medium  
(HDMI / CFe / SD, HDMI)



## VIDEO STYLE

### IMAGE PROPERTIES

The image properties of video recordings can be changed slightly using several parameters. These are summarized in pre-configured [Video Style](#) profiles.

### CONTRAST

The contrast setting, i.e. the difference between light and dark image sections, determines whether an image comes across as “flat” or “brilliant”. Increasing or decreasing this difference impacts on contrast, meaning that some image sections are rendered brighter or darker.

### SHARPNESS

The impression of sharpness in a picture is largely determined by edge sharpness, i.e. by how slight the transition area between light and dark is at edges in the shot. Expanding or reducing these areas will therefore change the impression of sharpness.

### COLOR SATURATION

The saturation factor in color images determines, whether colors in the shots appear “pale” and pastel-like or “bright” and colorful. While lighting conditions and weather (e.g. foggy/clear) are given in terms of shooting conditions, their rendering can be influenced.

## HIGHLIGHT/SHADOW

Depending on the exposure selected and the dynamic scope of the object, some details in brighter or darker areas may no longer be clearly visible. The parameters [Highlight](#) and [Shadow](#) allow differentiated control over very brightly or less brightly lit areas. Where, for example, part of the object is in shadow, a higher setting for [Shadow](#) can help brighten these areas to make details more visible. Conversely, existing shadows or particularly bright areas might be additionally emphasized for reasons of image composition. Positive values will brighten the targeted areas, while negative values will darken them.

## VIDEO PROFILES

### COLOR PROFILE

3 pre-configured color profiles are available:

- STD **Standard**
- VIV **Vivid**
- NAT **Natural**

- ▶ Select **Video Style** in the main menu
- ▶ Select a profile

### MONOCHROME PROFILE

There are two additional profiles available for monochrome video recordings:

- BW **Monochrome**
- BW **Monochrome High Contrast**

- ▶ Select **Video Style** in the main menu
- ▶ Select a profile

### Note

- The **Video Style** function is unavailable if any other setting but **Off** is selected for **Video Gamma**.

## CUSTOMIZING VIDEO PROFILES

These parameters can be adjusted for all available profiles (**Saturation** only for color profiles). See p. 74 for details on menu operation.

- ▶ Select **Video Style** in the main menu
- ▶ Select **Video Style Settings**
- ▶ Select a profile
- ▶ Select **Contrast/Highlight/Shadow/Sharpness/Saturation**
- ▶ Select the desired level  
(-2, -1, 0, +1, +2)

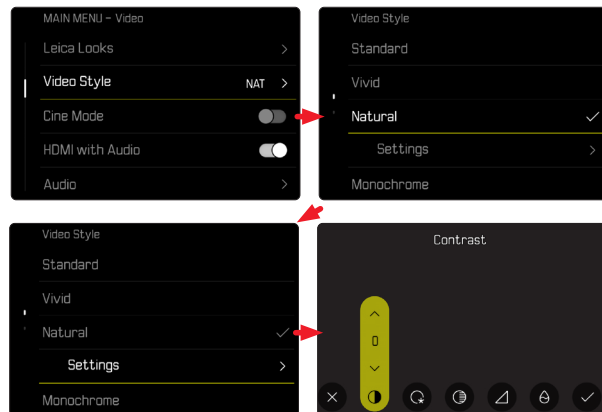



## AUDIO SETTINGS

### MICROPHONE

The sensitivity of the integrated microphone can be set.

Factory setting: 0 dB

Via the Control Center



### About the menu

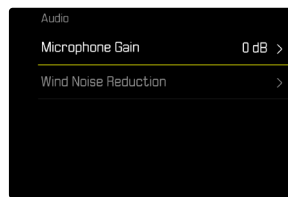

- ▶ Select **Audio** in the main menu
- ▶ Select **Microphone Gain**
- ▶ Select the desired level

(Off, +6 dB, +5 dB, +4 dB, +3 dB, +2 dB, +1 dB, 0 dB, -1 dB, -2 dB, -3 dB, -4 dB, -5 dB, -6 dB, -7 dB, -8 dB, -9 dB, -10 dB, -11 dB, -12 dB)



## Notes

- The Autofocus function and manual focusing adjustments generate noise that may be picked up in the recording.
- There will be no audio recorded if this setting is **Off**. As notification, the icon for the recording level changes as shown here .

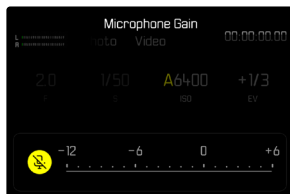

## WIND NOISE REDUCTION

Wind noise reduction can be adjusted individually for the internal and the external microphone.

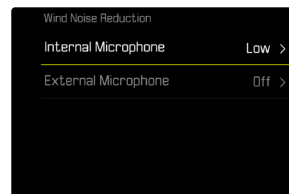

### INTERNAL MICROPHONE

Factory setting: **Low**

- ▶ Select **Audio** in the main menu
- ▶ Select **Wind Noise Reduction**
- ▶ Select **Internal Microphone**
- ▶ Select the desired setting (**High**, **Low**, **Off**)

### EXTERNAL MICROPHONE

Factory setting: **Off**

- ▶ Select **Audio** in the main menu
- ▶ Select **Wind Noise Reduction**
- ▶ Select **External Microphone**
- ▶ Select the desired setting (**High**, **Low**, **Off**)



## TIMECODE

The timecode is a data record that is generated and recorded alongside the image and audio data. It ensures the correct time assignment of frame and audio signals after cutting or after later separate processing. Timecode mode and start time can be selected.

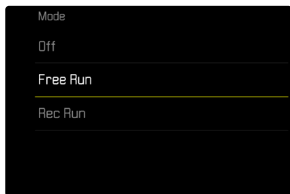
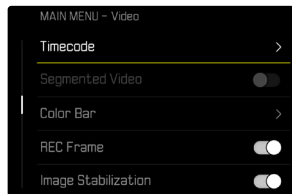

## TIMECODE MODE

Time information is written to the recorded video file if the timecode setting is activated.

Factory setting: **Off**

Off	Timekeeping begins at 00:00:00.00 for every recording.
Free Run	The timer continues running regardless of whether the camera is currently recording video.
Rec Run	The timer only runs while a video is being recorded. The timer will stop when recording ends and will continue when the next recording starts.

- ▶ Select **Timecode** in the main menu
- ▶ Select **Mode**
- ▶ Select the desired setting (**Off**, **Free Run**, **Rec Run**)



## START TIME

The start time can be reset manually or can be set to a specific value if multiple cameras are used for recording. Alternatively, the current time set in the camera can be specified as the timecode.

- ▶ Select **Timecode** in the main menu
- ▶ Select **Start Time**
- ▶ Select the desired setting  
(**Reset Timecode**, **Manual**, **Camera Time**)

The desired start time can be set in the format hour:minute:second:frame if **Manual** is selected.

## TC SYNCHRONIZATION

There is a choice of two methods for syncing the timecode record: The option **External** applies data from a connected timecode generator. It dictates the timecode signal. The camera applies the data received from the external signal.

The option **Master** forces the camera to apply the timecode signal generated by its internal timecode generator. The externally connected timecode generator applies the signal received from the camera and forwards it to the network.

- ▶ Select **Timecode** in the main menu
- ▶ Select **TC Synchronization**
- ▶ Select the desired setting  
(**External**, **Master**)

## VIDEO GAMMA

Video gamma can be set to HLG and L-Log or can be deactivated altogether.

Off	Optimization for playback compatible with all screen/TV devices in compliance with the BT.709 standard.
HLG	Optimization for HDR-capable UHD-TV devices.
L-Log	Optimization for professional reworking, e.g. color grading.

Factory setting: Off

- ▶ Select **Log Settings** in the main menu
- ▶ Select **Video Gamma**
- ▶ Select the desired setting  
(Off, HLG, L-Log)

### Notes

- **Video Gamma** is not available under the following conditions:
  - Recordings in MP4 format
  - Recordings in 8 bit
  - Recordings in slow motion
- The following functions are unavailable when **Video Gamma** is used:
  - iDR
  - Video Style

## HLG SETTINGS

Sharpness and saturation can be set. The factory setting is a median value 0 in both cases.

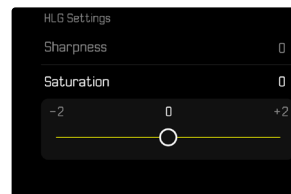
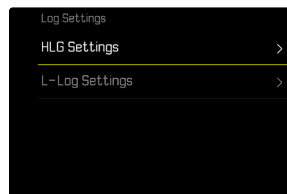

- ▶ Select **Log Settings** in the main menu
- ▶ Select **HLG Settings**
- ▶ Select **Sharpness** or **Saturation**
- ▶ Select the desired setting  
(-2, -1, 0, +1, +2)

## L-LOG SETTINGS

The sharpness for L-Log can be adjusted. Additionally, various LUT profiles can be applied as preview when using L-Log. Saved recordings remain unaffected.

### SHARPNESS

Factory setting: **-2**

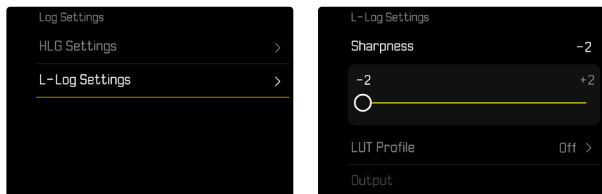

- ▶ Select **Log Settings** in the main menu
- ▶ Select **L-Log Settings**
- ▶ Select **Sharpness**
- ▶ Select the desired setting (**-2, -1, 0, +1, +2**)

## SETUP/MANAGEMENT OF LUT PROFILES

You can import custom LUT profiles to the camera to optimally meet your LUT preview expectations.

- ▶ Select **Log Settings** in the main menu
- ▶ Select **L-Log Settings**
- ▶ Select **Custom LUT**
  - A list of six memory slots is displayed. Three are reserved for use with HDMI output, and three for internal camera use (LCD panel/EVF).
  - Filled memory slots will show the name of the saved LUT profile. Free memory slots display the word **Unused**.

### EXAMPLE

In the following, the assignment shown below will be used for all subsequent figures. Two profile slots for internal camera display (LCD panel/EVF) are taken, all others are unused.

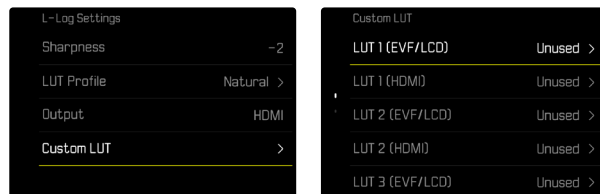



## Importing a custom LUT profile

- ▶ Download or export an LUT profile as a CUBE file
- ▶ Give the file a meaningful name (file name max. 8 characters, file ending “.cub”)
  - This file name (without the ending) will appear as a profile name in the camera after import. A later file name change on the camera will not be possible.
- ▶ Save the download to the memory card
  - Store the file in the main directory of the memory card (not in a sub-directory).
- ▶ Insert the memory card into the camera
- ▶ Select an unused memory slot
  - You will have to delete an existing profile first if there is no unused memory slot available.
  - The “Import” dialog appears. It displays the files found on the memory card.
  - The message **Import Failed** will appear if the camera does not find a compatible file.
- ▶ Select the profile to import
- ▶ Select **Yes**

## Notes

- You can only import LUT profiles with the file ending “.cub”.
- Files with the ending “.cube” will not be recognized. These can, however, simply be renamed before saving them to the SD card.
- File names must be max. 8 characters (incl. spaces) long.
- Incompatible files will not be recognized.
- A maximum of six profiles saved to the memory card will be displayed. The profiles found on the card will be displayed chronologically in ascending order: the most recently saved profile will appear at the top.
- In rare cases, a particular combination of memory card and computer may result in a search returning only three profile files.
- Where two memory cards are in use, and both contain compatible files, only the files on SD1 will be considered.



## Freeing a memory slot

- ▶ Select a profile
  - The “Delete” dialog appears.
- ▶ Select **Yes**

## Notes

- The pre-configured profiles **Natural** and **Classic** cannot be deleted.
- A profile that is currently in use cannot be deleted.

## USING LUT PROFILES

### CHANGING THE OUTPUT CHANNEL

The user can choose to apply the LUT profile for output via HDMI or in the camera (LCD panel/EVF).

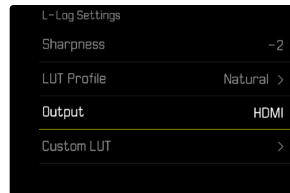
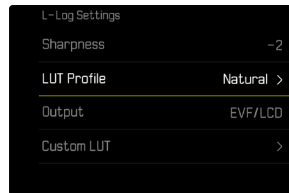

- ▶ Select **Log Settings** in the main menu
- ▶ Select **L-Log Settings**
- ▶ Select **Output**
- ▶ Select the desired setting (**EVF/LCD**, **HDMI**)

## Note

- The menu item **Output** is unavailable if the setting **Off** is selected for **LUT Profile**.



When toggling between the two output channels, the setting for the selected memory slot will remain unchanged. Since it is possible that different profiles are saved on the same slot depending on the output channel, it is possible that a different profile or an unused memory slot is selected. The name of the active profile will change accordingly next to the menu item **LUT Profile**. This does not apply for the pre-configured profiles, which exist on the same memory slot for both output channels.

## SELECTING THE LUT PROFILE

In addition to the two pre-configured LUT profiles, three more memory slots are available for custom LUT profiles.

- ▶ Select **Log Settings** in the main menu
- ▶ Select **L-Log Settings**
- ▶ Select **LUT Profile**
  - The list of profiles available for the active output channel appears.
- ▶ Select the desired setting  
(**Off**, **Natural**, **Classic**, **LUT 1**, **LUT 2**, **LUT 3**)

### Note

- Unused memory slots appear in the list as **LUT 1**, **LUT 2**, and **LUT 3**. A memory slot filled with a custom LUT profile will display its name instead.

The list of selectable LUT profiles depends on the currently selected output channel (camera/HDMI). The channel is displayed next to the menu item **Output**. When the channel is set to **HDMI**, the selection list will display the profiles available for HDMI output. The setting **EVF-LCD** will therefore show the profiles available for camera display.



## AUTOMATIC OPTIMIZATION

### VIDEO STABILIZATION

With video recording – in addition to optical stabilization by means of appropriately equipped lenses – a independent digital stabilization function is available that can be used with any lens. This function is particularly useful in conjunction with lenses that do not feature an OIS function.

Factory setting: **On**

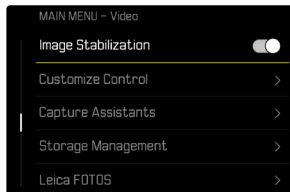

- ▶ Select **Image Stabilization** in the main menu
- ▶ Select **On**

## DARK AREA OPTIMIZATION (IDR)

### DYNAMIC RANGE

The contrast range of an object comprises all levels of brightness from the brightest to the darkest point in the image. All levels of brightness can be captured by the sensor, provided the contrast range of the object is lower than the dynamic range of the camera. In case of significant differences of brightness in the object (e.g. shootings of interior spaces with bright windows in the background, shootings with subject elements in shadow or directly lit by the sun, landscapes with dark areas and a very bright sky), the camera with its limited dynamic range will not be able to map the entire contrast range of the object. Information in 'edge areas' will be lost (under and overexposure).

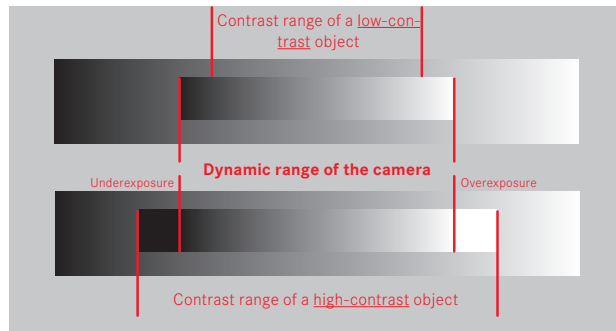

## iDR FUNCTION

The **iDR** (Intelligent Dynamic Range) function allows an optimization of the darker areas. Object details become much clearer.



You can specify beforehand if and to what extent you want to optimize darker areas (**High**, **Standard**, **Low**, **Off**). In the **Auto** setting, the camera will automatically select the right setting depending on the contrast range of the object.

In addition to that setting, the effect also depends on the exposure settings. The function will have the strongest effect in combination with low ISO values and fast shutter speeds. The effect is less pronounced with higher ISO values and/or slower shutter speeds.

Factory setting: **Auto**

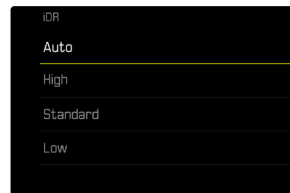
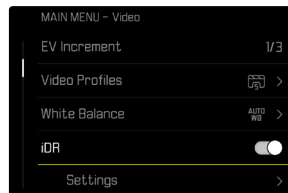

- ▶ Select **iDR** in the main menu
- ▶ Activate the function
- ▶ Select **Settings**
- ▶ Select the desired setting (**Auto**, **High**, **Standard**, **Low**)

### Note

- The optimization of darker areas will slightly reduce differentiation in very bright areas.

## DATA MANAGEMENT

### SEGMENTED RECORDING

Videos recorded in MOV format can be automatically segmented into individual one-minute files and saved. This method protects recordings against technical errors during the write process, in case the recording is interrupted. All previously saved one-minute segments will remain intact.

Factory setting: **Off**

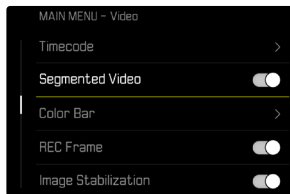

- ▶ Select **Segmented Video** in the main menu
- ▶ Select **On**

#### Notes

- This function is not available for the **MP4** video format setting.
- The individual recordings will not be played back automatically in sequence.
- Essential for segmentation is the playback time of the finished recording. Slow motion recordings will be segmented in a way that the finished recordings will have a playback time of about one minute.

### FORMATTING A MEMORY CARD

Memory cards that have already been in use with this camera will usually not require formatting. An unformatted memory card that is inserted into the camera for the first time must be formatted. We recommend formatting memory cards from time to time, because residual data traces (data pertaining to individual shots) may reduce the card's storage capacity.

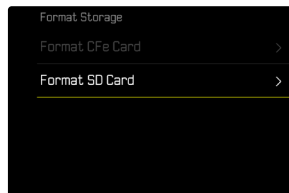
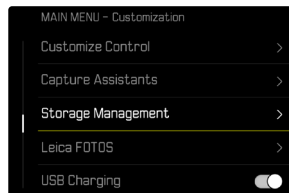

- ▶ Select **Storage Management** in the main menu
- ▶ Select **Format Storage**
- ▶ Select **Format CFe Card/Format SD Card**
- ▶ Confirm the selection
  - The status LED will flash during the process.



## Notes

- Never switch off the camera while data transfer is in progress.
- All data stored on the memory card will be lost during formatting. Formatting will not be prevented by the deletion protection set for individual shots.
- All images should therefore be regularly transferred to a safe mass storage medium, e.g. the hard disk of a computer.
- A simple formatting process will initially not irretrievably destroy existing data on the card. Only the directory will be deleted, which means the data will no longer be directly accessible. Data access can be restored with appropriate software. Only data that is overwritten when new data is saved will actually be irretrievable.
- A memory card should be formatted again in the camera if it was formatted in another device, e.g. a computer.
- Contact your retailer or Leica Customer Care for assistance if the memory card cannot be formatted/overwritten (see p. 340).

## DATA STRUCTURE

### FOLDER STRUCTURE

The files (= shots) on the memory cards are saved in automatically generated folders. The first three characters signify the folder number (numerals), the last five the folder name (letters). The first folder is assigned the name "100LEICA", the second "101LEICA". A folder will always be created with the next available number; you can have max. 999 folders.

### FILE STRUCTURE

The file names in these folders consist of eleven characters. In the factory settings, the first file is named "L1000001.XXX", the second "L1000002.XXX", etc. The first letter can be selected, the "L" from the factory settings denotes the camera brand. The first three characters signify the folder number (numerals). The next four digits denote the sequential file number. Once file number 9999 is reached, then a new folder will be automatically created, in which the file numbering begins at 0001 again. The last three places after the dot denote the file format (DNG or JPG).

## Notes

- When using memory cards that were not formatted with this camera, the file numbering will begin with 0001 again. Should the memory card already contain a file with a higher number, then numbering will be continued from that number.
- A relevant message will be displayed on the LCD panel once folder number 999 and file number 9999 are reached, and all numbering must be reset.
- Format the memory card and reset the frame number right after to reset the folder number to 100.

## EDIT FILE NAMES

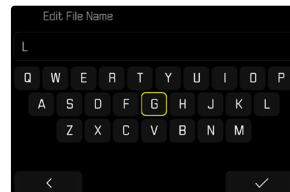
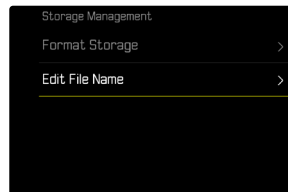

- ▶ Select **Storage Management** in the main menu
- ▶ Select **Edit File Name**
  - A keyboard submenu is displayed.
  - The input line contains the factory setting “L” as the first letter of the file name. Only this letter can be changed.
- ▶ Enter a letter of your choice (see p. 71)
- ▶ Confirm

## Notes

- The change to a file name applies to all subsequent shots or until a new change is made. The sequential number will not be affected; but it will be reset when a new folder is created.
- During a reset to factory settings, the first letter will always be reset to “L”.
- Lower case letters are unavailable.



## CREATING A NEW FOLDER

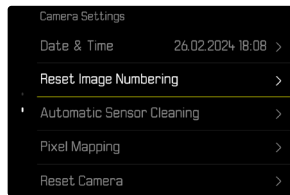

- ▶ Select **Camera Settings** in the main menu
- ▶ Select **Reset Image Numbering**
  - A relevant prompt is displayed.
- ▶ Confirm the creation of a new folder (**Yes**) or cancel the new folder (**No**)

### Note

- The name part (first letter) of a new folder created this way remains unchanged. The file numbers in that folder will start again at 0001.

## ADDING COPYRIGHT INFORMATION

This camera allows you to enter letters and other characters as a copyright mark for your image files.

You can enter up to 20 characters of information under 2 headings per shot.

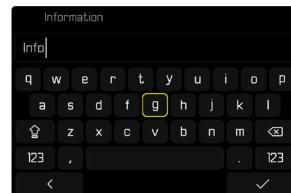
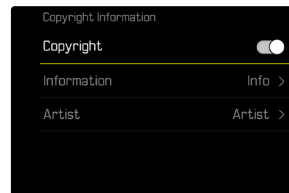

- ▶ Select **Camera Information** in the main menu
- ▶ Select **Copyright Information**
- ▶ Activate the **Copyright** function
- ▶ Select **Information/Artist** in the submenu
  - A keyboard submenu is displayed.
- ▶ Enter the desired information (see p. 71)
- ▶ Confirm

## LOGGING THE SHOOTING LOCATION (ONLY IN CONNECTION WITH THE LEICA FOTOS APP)

Location information can be sourced from a mobile device in connection with the Leica FOTOS app. Current location information will then be written to the Exif data of the images (geotagging).



- ▶ Activating GPS functions on a mobile device
- ▶ Activate Leica FOTOS and connect to the camera (see chapter “Leica FOTOS”)
- ▶ Activate geotagging for this camera in Leica FOTOS

### Notes

- The use of GPS and associated technologies may be restricted in some countries or regions. Violations will be prosecuted by local authorities. You should therefore contact your travel agent or the embassy of your destination country for relevant information beforehand.
- It will take a few seconds for the Bluetooth connection to establish. The configured shutdown time should be considered when choosing a delay time if shutdown is enabled in the camera.

## GEOTAGGING STATUS

The status of the current location information is displayed in the Control Center.

	The location information is current (most recent geolocation max. 15 mins prior).
	The location information is not necessarily current anymore (most recent geolocation max. 12 h prior).
	The available location information is outdated (most recent geolocation more than 12 h in the past). No location data will be written to Exif data.
No icon	Geotagging is deactivated.

Location information will be continuously updated as long as the camera is connected to Leica FOTOS. The Bluetooth function of the camera and the mobile device must therefore remain enabled to ensure latest information. It is, however, not necessary for the app to be running in the foreground.



## DATA TRANSFER

Data can be conveniently transferred to mobile devices via Leica FOTOS. Alternatively, a card reader or USB cable can be used for the transfer.

### ABOUT LEICA FOTOS

- ▶ See chapter “Leica FOTOS” (p. 294)

### VIA USB CABLE OR “LEICA FOTOS CABLE”

The camera supports multiple data transfer options. A transfer mode can be permanently selected or chosen every time a connection is established.

Factory setting: **Select on Connection**

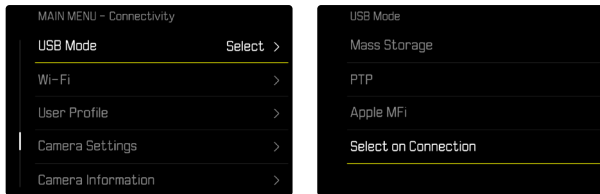

- ▶ Select **USB-Mode** in the main menu
- ▶ Select the desired setting (**Mass Storage**, **PTP**, **Apple MFi**, **Select on Connection**)

- **Apple MFi** is used for the communication with iOS devices (iPhone and iPad)
- **PTP** allows a data transfer to computers using MacOS or Windows with PTP-capable programs, as well as tethering to Capture One Pro and Lightroom Classic
- The setting **Select on Connection** will automatically propose a connection method depending on the type of cable connection.

### Notes

- We recommend using a card reader for the transfer of large files.
- The USB connection must not be interrupted while data is being transferred, as the computer or the camera could otherwise “crash” and irreparable damage could occur on the memory card.
- The camera must not be turned off or automatically shut itself down due to a lack of battery power while data is being transferred, as this can cause the computer to crash. For the same reason, the battery must never be removed from the camera while the connection is active.







## PRACTICAL DEFAULT SETTINGS

### TOUCH AF

Touch AF allows a direct placement of the AF frame.

Factory setting: **Touch AF**

- ▶ Select **Focusing** in the main menu
- ▶ Select **Touch AF**

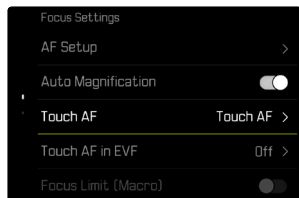

- ▶ Select **Touch AF**

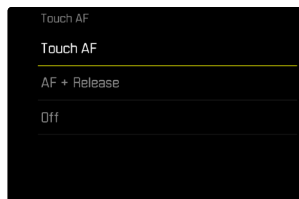

### Positioning the AF frame

- ▶ Tap the LCD panel in the desired position

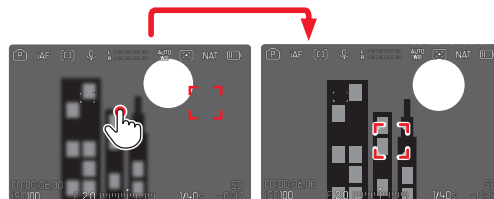

### Moving the focus frame back to the center of the screen

- ▶ Double-tap the LCD panel

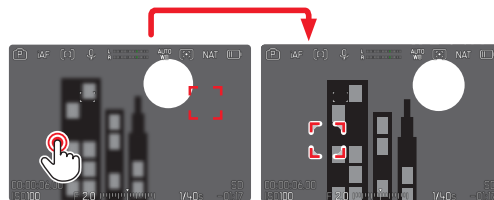

### Notes

- This function is available with all AF metering methods except **Multi-Field**.
- If the metering method **Tracking** is selected, the focus frame will remain at the selected position and autofocus commences when the shutter button is tapped. For all other AF metering methods, focusing occurs automatically.
- The position of the AF frame can only be reset with a double-tap, even if the setting is **Off**.

## TOUCH AF + SHUTTER BUTTON

The combination **Touch AF + Release** allows a direct placement of the AF frame for immediate recording.

- ▶ Select **Focusing** in the main menu
- ▶ Select **Touch AF**
- ▶ Select **Touch AF + Release**
- ▶ Tap the LCD panel in the desired position

### Note

- The AF frame cannot be reset as usual via a double tap if **Touch AF + Release** is activated.

## TOUCH AF IN EVF MODE

Touch AF is deactivated by default when EVF is in use to prevent any inadvertent altering of the AF frame. AF Quick Setting (see p. 123) continues to be accessible. This function can also be disabled if that is not wanted (e.g. when focusing with the left eye).

Factory setting: **Off**

- ▶ Select **Focusing** in the main menu
- ▶ Select **Touch AF in EVF**
- ▶ Select the desired setting  
(**On**, **AF Quick Setting only**, **Off**)
  - **AF Quick Setting only**
    - Accessing the AF Quick Setting (tap and hold)
  - **On**
    - Positioning the AF frame (tap)
    - Accessing the AF Quick Setting (tap and hold)
  - **Off**





## PERSONALIZED LENS SETTINGS

The total angle of rotation of the lens used for focusing can be individually adjusted. The setting selected indicates the angle of rotation required to change the focus setting from infinity to the nearest possible distance. Example: for a setting to **90°**, the entire focus range will be run through when the focus ring is turned by one quarter. A full turn of the focus ring will be needed for a setting to **360°**. Smaller values facilitate a faster, larger values a more precise adjustment. A setting to **Maximum** offers the highest precision.

Unlike the permanent settings, a setting to **Standard MF** will result in a non-linear dependency of rotation angle and focus setting. The extent of the change depends dynamically on the speed of rotation. With slow rotation, the same angle of rotation (e.g. 45°) causes a smaller change than with fast rotation.

Factory setting: **Standard MF**

- ▶ Select **Focus Settings** in the main menu
- ▶ Select **Manual Focus Throw**
- ▶ Select the desired setting  
(**Standard MF**, **90°**, **120°**, **150°**, **180°**, **210°**, **240°**, **270°**, **300°**, **330°**, **360°**, **Maximum**)

### Notes

- The settings **Standard MF** and **Maximum** are highly lens-dependent. **Maximum** may, for example, mean a rotation angle of 360° or 720°.

## EV INCREMENT

You can choose between 1/2 EV or 1/3 EV graduations. This will allow you to choose between stronger or more subtle effects for your relevant settings.

This setting doesn't just apply for exposure compensation settings. It also specifies the sensitivity of the setting wheels in standard shooting mode, i.e. the increment width with which the shutter speeds and the aperture will be set. A setting to **1/2** will change the shutter speeds and aperture values that much faster each time the dial is moved one click further and the correct setting is achieved quicker. A setting to **1/3** facilitates a more precise setting.

Factory setting: **1/3**

- ▶ Select **EV Increment** in the main menu
- ▶ Select the desired setting  
(**1/2**, **1/3**)

## AUDIO OUTPUT

### SETTING THE OUTPUT LEVEL

The volume level can be set for connected headphones.

- ▶ Press the function button **(9)**

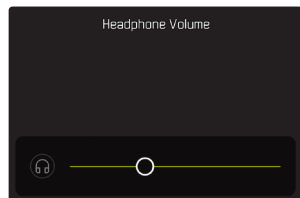

- ▶ Select the desired setting

## HDMI OUTPUT WITH/WITHOUT SOUND

HDMI output is available with or without audio.

Factory setting: **On**

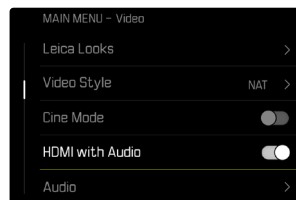

- ▶ Select **HDMI with Audio** in the main menu
- ▶ Select the desired setting

### Note

- An output with audio may result in some negligible delays. We recommend the setting **Off** to avoid this effect (if, for example HDMI Live View is required for a recording with an external recorder).





## AUXILIARY DISPLAYS

The Leica SL3 has 4 independent info profiles, which contain differing combinations of the available auxiliary displays. The following functions are available:

- Info Bars
- Grid lines (shooting mode only)
- Zebra
- Focus peaking
- Level Gauge (shooting mode only)
- Histogram (luminance or Waveform Monitor)
- Framelines

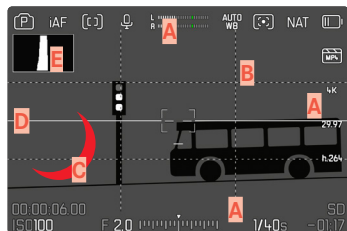

- A** Info bars (= header, footer, bar on the right)
- B** Grid lines
- C** Focus peaking
- D** Zebra
- E** Level gauge
- F** Histogram (depicted here: luminance histogram)

## INFO PROFILES

Up to 4 independent profiles can be used for video mode. The desired function can be selected and adjusted individually for each profile. During operation, the switch between info profiles is done via direct access (see p. 76). In factory settings, that will be the **FN** button. It allows quick switches between various views.

The following profiles are predefined in the factory settings:

Profile	Factory Settings	
1	Info bars only (Top / Bottom)	
2	Full screen view (all auxiliary displays Off)	
3	Info Bars (Top / Bottom + Right), Zebra, Focus Peaking, Histogram	
4	Info Bars (Top / Bottom + Right), Grids, Zebra, Level Gauge	

## CHANGING THE INFO PROFILES

- ▶ Press the function button with the **Toggle Info Levels** assignment
  - In factory settings, that will be the **FN** button.

### Note

- The same info profiles are available in playback mode as in shooting mode. The actual info profile currently in use, however, is saved separately.

## Briefly showing/hiding information

- ▶ Tap and hold the shutter button
  - (Only) the exposure information and currently active auxiliary functions will be visible.

## DEACTIVATING INDIVIDUAL INFO PROFILES

You can limit the number of info profiles by activating/deactivating individual profiles. At least one profile must always be active, but that can be an “empty” profile.

- ▶ Select **Capture Assistants** in the main menu
- ▶ Select a profile
- ▶ Select **On**



## CUSTOMIZING THE INFO PROFILES

- ▶ Select **Capture Assistants** in the main menu
- ▶ Select a profile
- ▶ Select **Settings**
- ▶ Select the desired function
- ▶ Select the desired setting

Function	Available settings
Info Bars	Top / Bottom (On, Off) Right (On, Off)
Grids	3 x 3, 6 x 4, Off
Zebra	Off, Upper Limit (value between 200 and 255)
Focus Peaking	On, Off Color (Red, Blue, Green, White) & Sensitivity (Low, Medium, High): Settings apply for <u>all</u> info profiles
Level Gauge	On, Off
Histogram	Luminance, Waveform Monitor, Off
Framelines	- 3 aspect ratio profiles (ration freely adjustable) - 2 completely customizable frameline profiles (Frame Size, Scale, Shading, Color, Frame Stroke, Frame Type)

### Note

- It is advisable to reserve one info profile as “empty”, in which all functions are set to **Off**. It allows you to temporarily hide all displays. In effect, you get an unobstructed view of the full screen image.

## SHOW AVAILABLE

### INFO BARS

The icons displayed represent currently active settings and exposure values. See chapter “Displays” for a full list of the various displays (see p.30).





## GRID LINES

The grids divide the image frame into multiple fields. They facilitate pictorial composition and an exact camera orientation. The grid line distribution can be adjusted to fit the object.



You can choose one of two grid displays. They divide the image field into 3x3 or 6x4 fields.

- ▶ Select **Capture Assistants** in the main menu
- ▶ Select a profile
- ▶ Select **Setting**
- ▶ Select **Grids**
- ▶ Select the desired setting  
(3 x 3, 6 x 4, Off)

## ZEBRA

The Zebra display marks very bright image areas. This function is a very easy and exact tool for checking the correct exposure setting. Overexposed areas will appear white with moving black stripes.

### SETTING THE LIMIT VALUE

You can set a threshold value for these displays, i.e. define a value at what degree of overexposure they will appear, so that you can adjust these displays to specific conditions or in line with your own composition ideas.

- ▶ Select **Capture Assistants** in the main menu
- ▶ Select a profile
- ▶ Select **Settings**
- ▶ Select **Zebra**
- ▶ Select **Upper Limit**
- ▶ Select the desired value  
(200 to 255)
- ▶ Tap and hold the shutter button
  - The Zebra display appears.



## FOCUS PEAKING

This assist function highlights the edges of in focus subject elements in color. The color can be user-specified. The sensitivity can be additionally adjusted.

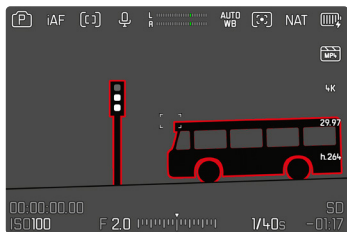

## HIGHLIGHT COLOR

The color can be user-specified. This setting will apply for all info profiles.

Factory setting: **Red**

- ▶ Select **Capture Assistants** in the main menu
- ▶ Select a profile
- ▶ Select **Settings**
- ▶ Select **Focus Peaking**
- ▶ Select **Color**
- ▶ Select the desired setting  
(**Red**, **Green**, **Blue**, **White**)

## SENSITIVITY

Factory setting: **Medium**

- ▶ Select **Capture Assistants** in the main menu
- ▶ Select a profile
- ▶ Select **Settings**
- ▶ Select **Focus Peaking**
- ▶ Select **Sensitivity**
- ▶ Select the desired setting  
(**Low**, **Medium**, **High**)

## Note

- Focus peaking is based on subject contrast, i.e. differences between light and dark. As a result, high contrast subject elements could be marked, even if they are not completely in focus.

## LEVEL GAUGE

The integrated sensors of the camera show its orientation. These indicators ensure exact camera orientation along the longitudinal and transverse axes of critical objects, e.g. architecture.

Deviations in relation to the longitudinal axis (i.e. when the camera is tilted up or down in the direction of view) are indicated by a short line in the center of the image (1). Deviations in relation to the transverse axis (when the camera is tilted to the left or right) are indicated by two long lines to the left and right of the image center (2).



- ▶ Select **Capture Assistants** in the main menu
- ▶ Select **Level Gauge**
- ▶ Select **On**

### Note

- The camera will switch the aspect of the level gauge automatically for shoots in vertical format.

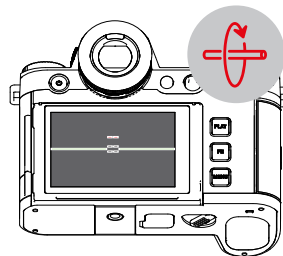
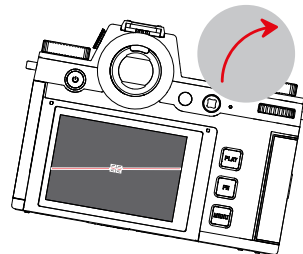
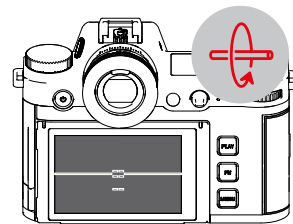
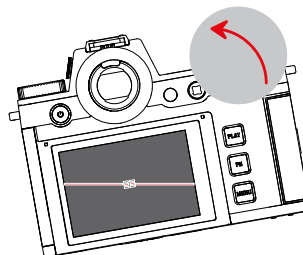
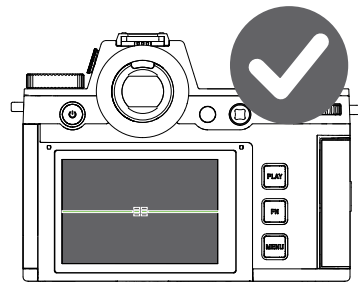



## HISTOGRAM

Histogram represents the brightness distribution in the image. The horizontal axis shows the graduated values from black (left) through gray to white (right). The vertical axis corresponds to the number of pixels at each brightness level.

This type of rendering allows an additional quick and easy assessment of the exposure setting.



Factory setting: **Off**

- ▶ Select **Capture Assistants** in the main menu
- ▶ Select a profile
- ▶ Select **Settings**
- ▶ Select **Histogram**
- ▶ Select **Luminance**

## Notes

- The histogram is always based on the brightness displayed; depending on the settings used, it may not represent the final exposure.
- In shooting mode, the histogram should be regarded as a “trend indicator”.
- The histogram during rendering may differ slightly from the one during exposure.
- The Histogram always refers to the currently displayed cropped section of the image.



## WAVEFORM MONITOR (WFM)

The Waveform Monitor (WFM) allows a quick and safe assessment of the luminance and color distribution within the current scene. Image faults become more easily apparent, which might otherwise be missed while recording with a smaller screen.

Factory setting: **Off**

- ▶ Select **Capture Assistants** in the main menu
- ▶ Select a profile
- ▶ Select **Settings**
- ▶ Select **Histogram**
- ▶ Select **Waveform Monitor**



The Waveform Monitor displays the luminance distribution for the entire visible image as a percentage (IRE). A value of 0% corresponds to a luminance value of 16 (in 8-bit encoding), while a value of 100% corresponds to a luminance value of 235 (in 8-bit encoding).

The visualization displays solid lines at 0%, 50%, and 100%. The dotted lines below them represent the values 109% and -4%.

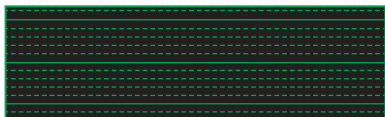

## Notes

- Waveform Monitor and Histogram cannot be displayed at the same time.
- The Waveform Monitor will not be displayed on the external device during HDMI output.
- The Waveform Monitor is available only in shooting mode, not in playback mode.
- The exposure compensation and ISO values (ISO only when accessed directly) can be adjusted using a menu bar. The screen image remains visible and shows the immediate effect of the selected setting. Should the Waveform Monitor be active, then it will remain visible in these cases, and will also display the effects of the latest setting.



## ADJUSTING VISUALIZATION

The size and position of the Waveform Monitor can be adjusted to current requirements.

### Starting the adjustment

- ▶ Touch and hold the LCD panel on the Waveform Monitor
  - White triangles appear at two corners of the Waveform Monitor. All other displays disappear.

### Adjusting the size

The size is adjustable in four increments.

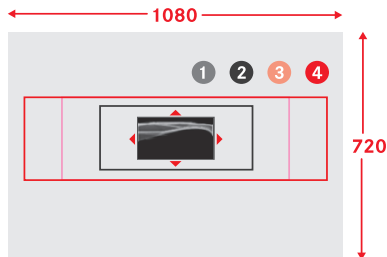

- ▶ Turn the thumbwheel  
(to the right: larger, to the left: smaller)
- or
- ▶ Two-finger pinch/spread

### Note

- The Waveform Monitor will appear smaller in the EVF than on the LCD panel.

## Adjusting the position

You can choose any position.

- ▶ Press the joystick in the relevant direction  
or
- ▶ Tap the LCD panel in the desired position

### Completing the adjustment

- ▶ Press the joystick/thumbwheel  
or
- ▶ Tap the shutter button

## ASPECT RATIO DISPLAY

The actually recorded aspect ratio depends on the set resolution (see p. 235). It is possible, however, to have colored auxiliary lines displayed to show other aspect ratios (e.g. 4:3). Multiple auxiliary lines can be displayed at the same time. No auxiliary lines are displayed in factory settings.

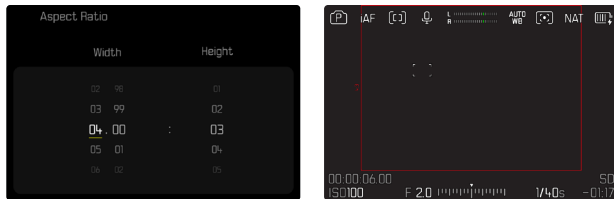

- ▶ Select **Capture Assistants** in the main menu
- ▶ Select a profile
- ▶ Select **Setting**
- ▶ Select **Framelines**
- ▶ Select the desired setting  
(4:3, 5:3, 37:20)

### Notes

- The format limits of a wider aspect ratio (than that of the recorded video) are indicated by horizontal green lines, those of a narrower one by vertical red lines.
- The auxiliary lines are labeled with the relevant aspect ratio.

## FRAMELINE

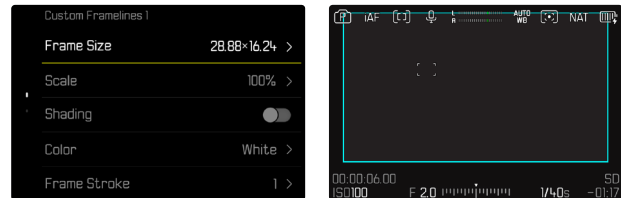

- ▶ Select **Capture Assistants** in the main menu
- ▶ Select a profile
- ▶ Select **Setting**
- ▶ Select **Framelines**
- ▶ Select a profile  
(Custom Framelines 1, Custom Framelines 2)
- ▶ Select the desired setting



## VIDEO ASSIST FUNCTIONS

### REFERENCE VALUES

A color bar can be displayed and also recorded for calibration purposes. A test sound with a frequency of 1 kHz will (optionally, three volume settings) be emitted.

### COLOR BAR

A choice of three color bars (SMPTE, EBU, ARIB) is available.

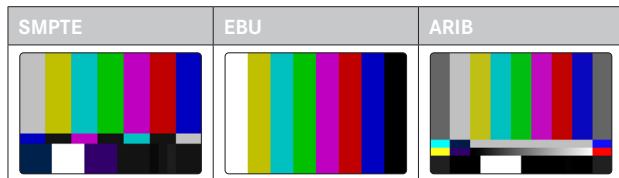

- ▶ Select **Color Bar** in the main menu
- ▶ Select the desired setting  
(Off, SMPTE, EBU, ARIB)

### OPERATING HINT/AUXILIARY DISPLAYS

The test image will always appear regardless of the current Info Profile settings. An operating hint is displayed. The info displays can be accessed at any time.

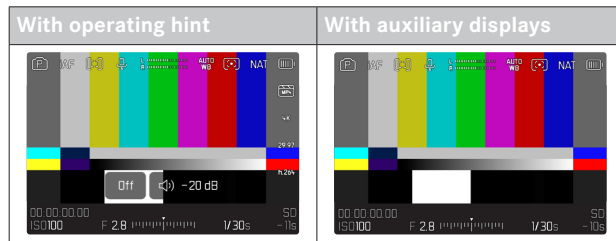

### Displaying information and auxiliary displays

- ▶ Press the function button with the **Toggle Info Levels** assignment
  - In factory settings, that will be the **FN** button.
  - The operating hint is hidden and the most recently active Info Profile is displayed.
  - The following auxiliary displays will not appear while the color bar is visible: Focus Peaking, Histogram, Level Gauge, Zebra.

### Ending the display of the color bar

- ▶ Press the joystick/thumbwheel
  - The color bar and test sound end.



## TEST SOUND

A test sound with a frequency of 1 kHz will be emitted whenever the color bar is accessed. Der operating hint at the top right of the image shows the current volume. Available setting options: **Off**, **-20 dB**, **-18 dB**, **-12 dB**. The selected setting will remain for all subsequent accesses.

Factory setting: **-18 dB**

### Setting the volume

- ▶ Press the joystick left/right

or

- ▶ Turn the thumbwheel to the left/right

### Notes

- The operating hint will be hidden after ten seconds have elapsed without any change to the volume setting and will reappear, when the next change is made.
- During HDMI output, the test sound will only be output on the connected device and not on the camera.
- During HDMI output, the test sound will be output on the connected device even if the menu item **HDMI Output** is set to **Without Audio**.
- During HDMI output, the operating hint will only be displayed in Live View mode of the camera, and not on the external device.

## APPLICATION

For HDMI output, the reference values are used for the configuration of the external device. The reference values can be irrespectively recorded at the start of a video for later use in post-production.

- ▶ Select the desired color bar
- ▶ Set the volume or mute the test sound
- ▶ Display Info Displays as needed
- ▶ Press the shutter button
  - Start the recording. The test sound is no longer output via the speakers, but will still be recorded.
- ▶ Press the joystick/thumbwheel
  - The color bar and test sound end.
  - Recording continues.



## REC FRAME

The timecode counter highlighted in red signifies a running video recording. The option REC Frame offers an even better visualization of the process. With the option set to **On**, the entire screen content will be framed. It will appear in red while the camera is recording video.

Factory setting: **On**

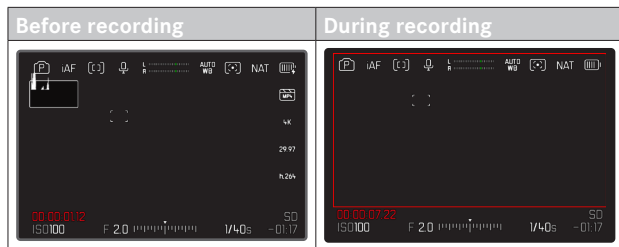

- ▶ Select **REC Frame** in the main menu
- ▶ Select **On**

## Quick option for hiding/displaying the REC Frame

The red dot is part of the info bars and is displayed or hidden alongside them (via the Info profiles). The recording status will still be displayed via the REC frame, without impeding the view of the image content. The REC frame can also be displayed or hidden while recording.

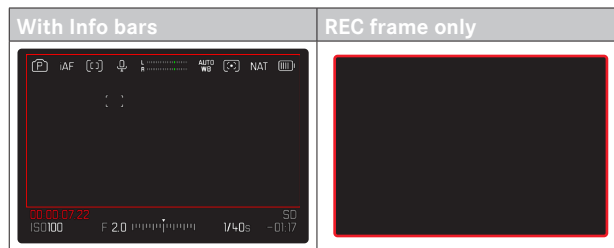

- ▶ Assigning the **REC Frame** setting to a function button
- ▶ Press the function button
  - Displays/hides the REC Frame.

## MF ASSIST FUNCTIONS



### AF ASSIST LAMP

The AF assist lamp could be a visible disturbance in video recordings and is therefore always without function in video mode, no matter the setting for [AF Assist Lamp](#).

### ACOUSTIC AF CONFIRMATION

You can set an acoustic confirmation signal for successful focus metering in AF mode.

- ▶ Select [Camera Settings](#) in the main menu
- ▶ Select [Acoustic Signal](#)
- ▶ Select [AF Confirmation](#)
- ▶ Select [On](#)
- ▶ Select [Volume](#)
- ▶ Select [Low/High](#)

#### Note

- The signal only appears during the focusing for a recording, not during recording.



## RECORDING VIDEO

The settings described in this chapter only apply for video operations. They are therefore part of the video menu and must always be accessed and configured from within video mode (see chapter “Camera operation” in the section “Menu Control”). Any menu items of the same name in the photo menu are not affected.

### Notes

- As only part of the sensor area is used in video recordings, the relevantly effective focal length is increased, which slightly reduces the size of the image sections.
- The max. file size for uninterrupted video recording is 192 GB. Once a recording exceeds this file size, the overrun will be automatically stored in a new file.
- Some menu items are unavailable in Video mode. The text in the relevant line is displayed in gray to signify the existence of a submenu.
- Unlike in photo mode, the joystick is used exclusively for focusing (metering and saving) in video mode. A coupling of exposure metering and focusing is not done, no matter which metering method is selected.
- The automatic LCD panel and EVF shutdown will also deactivate the AF system (see p. 89). We therefore recommend the **Off** setting if autofocus is to be used in HDMI recordings.

## VIDEO MODE AND CINE MODE

Cine mode is optimized for use by cinematography professionals. The mode is reduced to the most important points and the use of terminology from cinematography ensure a seamless user experience.

(Semi) automatic exposure programs (**F**, **A**, **S**) and the automatic control of light sensitivity (**Auto ISO**, **Floating ISO**) remain disabled. Light sensitivity is stated as an **ASA** value.

Unlike other video modes, the shutter speeds are not set as absolutes, but as shutter angles, relative to the selected frame rate.

In conjunction with suitable lenses, the Cine mode allows the Leica SL3 the use of T-stops to ensure exact same exposure scenarios independent of camera settings.

Factory setting: **Video**

## Activating Cine Mode

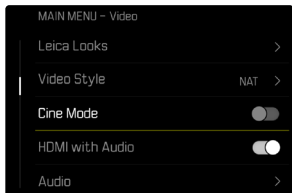

- ▶ Select **Cine Mode** in the main menu
- ▶ Select **On**

### Note

- The settings for light sensitivity (ISO/ASA), aperture and shutter speeds are saved separately for Video and Cine mode.

## START/EXIT VIDEO MODE

The camera will always be in Photo mode at initial activation or after a reset to factory settings. There are two methods for toggling between Photo and Video mode:

### Using touch control

#### Variant 1

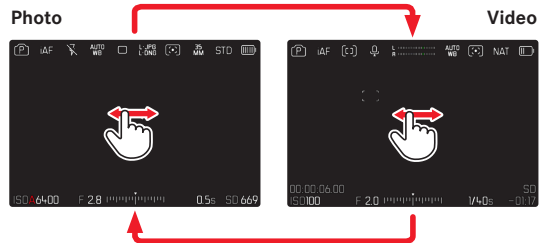

#### Variant 2

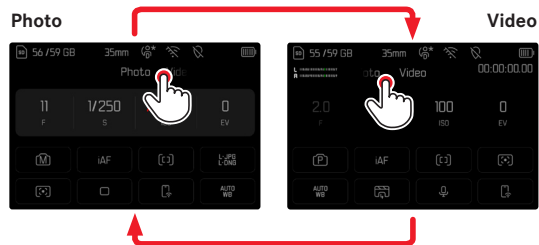

## Using button control

- ▶ Press the function button with the assignment **Photo <> Video**
  - In factory settings, that will be function button **F** (top left).

### Note

- The camera switches to the most recently set photo or video mode.

## START/END VIDEO RECORDING



- ▶ Press the shutter button
  - Video recording begins.
  - Timecode counter is highlighted in red.
  - Recording time is running.
  - The Status LED flashes.
- ▶ Press the shutter button again
  - Video recording ends.
  - Timecode counter is highlighted in gray.

### Notes

- The current shooting is shown in the top display with a dot below the mode.
- Basic shooting settings (see p. 196) must be configured before shooting.
- No direct access to menu functions is possible during video recording.



## DISPLAY AND OPERATION VIA USB-PTP USING EXTERNAL ACCESSORY (LIKE GIMBALS)

Leica SL3 allows connecting an optional Gimbal like DJI Ronin RS2 via USB-PTP. The Gimbal supports blur-free recordings.

- ▶ Select **USB-Mode** in the main menu
- ▶ Select **PTP** or **Select on Connection**
- ▶ Connecting the Gimbal to the camera (see Gimbal operating instructions)

Once the PTP connection is established, the camera can also be triggered via the shutter button on the Gimbal.

Many Gimbal models allow controlling the focus function of the camera, provided it is in MF mode.

### Note

- The camera screen will switch off for technical reasons if external devices connected to the USB or HDMI output are operated simultaneously.

## FOCUSING

Your Leica SL3 allows automatic as well as manual focusing. There are 3 operating modes and 4 metering methods available for automatic focusing. Only manual setting options are available for MF lenses.

### TAKING VIDEOS WITH AF

Focusing is done as needed when **AFs** is in use. The area in the AF metering field will be focused continuously if **AFc** and **Intelligent AF** are in use. Continuous focusing can be suppressed by using a metering memory lock.

### TAKING VIDEOS WITH MF

Focusing is done manually via the focus ring. The joystick can be used as needed to do an AF metering (in **AFs** mode).

### Note

- Autofocus can be overridden manually at any time by turning the focus ring, while pressing and holding the shutter button at the first pressure point. The set focus will remain unchanged until the shutter button is released.



## AUTOFOCUS MODES

The following AF modes are available: **AFs**, **AFc** and **Intelligent AF**. The currently selected AF mode is shown in the header line.

Factory setting: **Intelligent AF**

- ▶ Select **Focus Mode** in the main menu
- ▶ Select the desired setting  
(**Intelligent AF**, **AFs**, **AFc**)

### INTELLIGENT AF (iAF)

Suitable for all objects. In this mode, the camera will refocus as soon as it registers a color or brightness/contrast change in the entire image section. The focus field depends on the autofocus metering method selected.

### AFs (single)

A meaningful option if the focus setting should remain constant for an extended period of time. Allows greater control over focusing and helps to avoid incorrect focusing.

### AFc (continuous)

Suitable for objects in motion. Focusing is continuously adjusted to the object in the AF frame.

Facilitates an intuitive focus control, specifically in conjunction with Touch AF.

## CONTROLLING THE AUTOFOCUS

### TOUCH AF

During video recordings, Touch AF facilitates a more intuitive focus control, even if the main object moves outside the center of the frame. See p. 218 for more information.

- ▶ Tap the LCD panel in the desired position
  - Focusing is done after the touch.

### SUPPRESSING CONTINUOUS FOCUSING

Continuous focus adjustments can be suppressed by initiating a metering memory lock.

Use the following control elements depending on the currently selected mode:

Intelligent AF	Shutter button (tap and hold)
	Joystick (press and hold)
AFc	Joystick (press and hold)

The camera stores the focus setting. That makes it easier to change the image section when focusing is fixed. The focus remains constant as long as the control element is held. Automatic focusing will only resume after the control element is released.





## AUTOFOCUS METERING METHODS

The AF mode offers various metering methods for focusing. A successful focus setting is identified by a green frame, an unsuccessful one is shown in red.

Factory setting: **Field**



- ▶ Select **AF Mode** in the main menu
- ▶ Select the desired setting  
(**Multi-Field**, **Spot**, **Field**, **Zone**, **Tracking**, **Eye/Face/Body Detection**, **Animal Detection (Beta)**)

### Note

- AF focusing can be unsuccessful:
  - if the distance to the object is too great (macro mode) or too small
  - if the object is not sufficiently illuminated

## MULTI-FIELD

Several focus area are detected automatically.

## SPOT/FIELD

Both methods detect only those parts of the object that are within the relevant AF frames. The metering fields are indicated by a small frame (field metering) or a cross (spot metering). The very small measuring range for spot metering allows focusing on tiny details of the subject. Simply move the AF frame to another position.

The slightly larger measuring range in field metering is less critical for focusing, but still permits selective metering.

- ▶ Press the joystick in the relevant direction

or

- ▶ Tap the LCD panel in the desired position  
(While Touch AF is activated)

### Notes

- In both cases, the metering fields remain at their last positions set, even if the metering method is changed or the camera is switched off.
- The metering fields are joined together when the exposure metering method **Spot** is combined with the AF metering methods **Spot**, **Field** and **Zone**. Exposure metering will then occur at the point specified by the AF frame, even if it is moved.



## ZONE

With this metering method, subject sections are recorded with a coherent group comprising 5 x 5 fields.

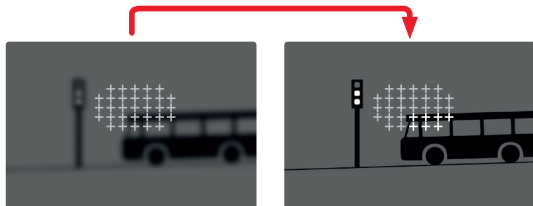

Once the setting has been made, the focus frames are displayed where object sections are displayed in focus.

## TRACKING

This field metering variant helps in the capture of moving objects. The focus on the object in the focus frame is continuously adjusted, once it is detected.

- ▶ Aim the focus frame at the desired object (by panning the camera shifting the focus frame)
- ▶ Tap and hold the shutter button

or

- ▶ Press and hold the joystick
  - The camera focuses on the object.
  - The focus frame “tracks” the saved object and focus is continuously adjusted.

### Note

- This metering method focuses continuously, even if the AF mode **AFs** was set.

## START POSITION FOR TRACKING

Factory setting: **Center**

You can specify the starting point for tracking.

Last Position	Ending position of the most recent tracking
Recall	Starting position of the most recent tracking
Center	Center of the screen

- ▶ Select **Focus Settings** in the main menu
- ▶ Select **AF Setup**
- ▶ Select **AF Tracking Start Position**
- ▶ Select the desired setting  
(**Last Position**, **Recall**, **Center**)

## PERSON DETECTION (FACE DETECTION)

Person detection is an expansion of the face detection feature. In addition to biometric patterns of faces, the camera also detects body patterns and uses them for focusing. Tracking will therefore continue, once a person is detected and measured, even if the face may not be in view at some point. This feature prevents inadvertent “jumps” to other faces if several persons are in the frame.

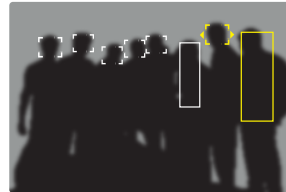



When face detection detects an eye, the focus will be on that eye. Should more than one eye be detected, then the user can choose the eye to focus on. The currently selected eye will be highlighted. Additionally, the desired face can be easily selected if there are several faces in the frame.



### Toggling between faces and/or eyes

- ▶ Press the joystick in the relevant direction

### ANIMAL DETECTION

This version of Eye/Face/Body Detection also includes the recognition of some typical pet types.

## AF SETTINGS

### SENSITIVITY

Specifies the sensitivity of contrast metering.

Factory setting: 0

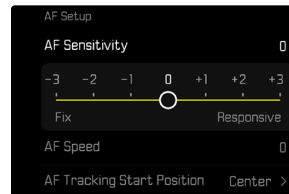

- ▶ Select **Focus Settings** in the main menu
- ▶ Select **AF Setup**
- ▶ Select **AF Sensitivity**
- ▶ Select the desired setting  
(-3, -2, -1, 0, +1, +2, +3)

## SPEED

Where objects are not as fast-moving, it is advisable to set AF Speed to a slightly lower value. This will prevent overly abrupt focus changes. For very fast-moving objects, a high setting will guarantee a correct focus.

Factory setting: 0

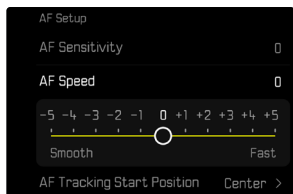

- ▶ Select **Focus Settings** in the main menu
- ▶ Select **AF Setup**
- ▶ Select **AF Speed**
- ▶ Select the desired setting  
(-5, -4, -3, -2, -1, 0, +1, +2, +3, +4, +5)

## FOCUS LIMIT

The focus area can be limited to the macro range. This will speed up automatic focusing considerably.

Factory setting: Off

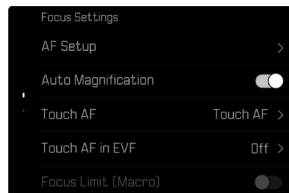

- ▶ Select **Focus Settings** in the main menu
- ▶ Select **Focus Limit (Macro)**
- ▶ Select **On**

### Notes

- The focusing range differs depending on the lens used (see relevant instructions).
- This function is not available for specific lenses:
  - lenses mounted via an adapter (e.g. Leica M lenses with L adapter M)
  - specific Leica SL lenses



## AF QUICK SETTING

The AF Quick Setting allows quick changes to the focus frame size in some AF metering methods.

The screen image will remain visible continuously while settings are being adjusted.

### ACCESSING AF QUICK SETTING

- ▶ Tap and hold the LCD panel
  - All auxiliary displays are hidden.
  - Red triangles appear at two corners of the focus frame if the metering method **Field**/**Zone**/**Eye**/**Face**/**Body Detection**/**Animal Detection (Beta)** is set.

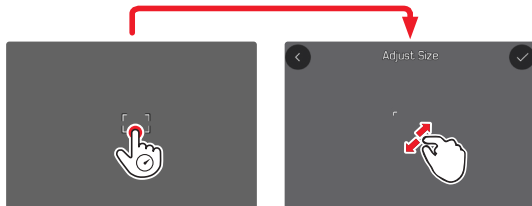

- In all other AF modes, the **AF Mode** menu bar will be displayed directly.

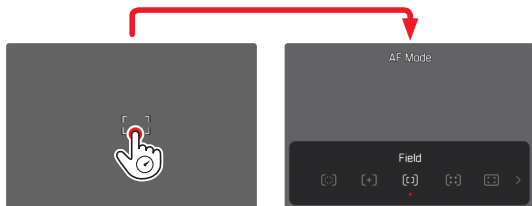

## ADJUSTING THE AF FRAME SIZE

(**Field**/**Zone**/**Eye**/**Face**/**Body Detection**/**Animal Detection (Beta)** only)

- ▶ Turn the thumbwheel
- or
- ▶ Two-finger pinch/spread
  - The size of the AF frame is adjustable in 3 increments.

### CHANGING THE AF METERING METHOD

The user needs to access the **AF Mode** menu bar first if the active AF mode is **Field** or **Eye**/**Face**/**Body Detection**:

- ▶ Press the function button at the front (bottom)
  - The **AF Mode** menu bar appears.
- ▶ Use the thumbwheel to select the desired metering method
  - Alternatively, you can use the right dial for the setting.
  - The setting is applied automatically after 3 seconds, the menu bar disappears.

### Note

- AF Quick Setting can only be accessed via the right dial if the function **Touch AF** is active (see p. 218).

## MF ASSIST FUNCTIONS

### ENLARGEMENT IN AF MODE

You can access the enlargement function independent of focusing for a better assessment of the settings.

The function **Magnification** must be assigned to one of the function buttons to use this feature (see p. 76).

Factory setting: Function button at the front (top)

#### Assigning a function to a specific function button

- ▶ See p. 76

#### Accessing the enlargement function

- ▶ Press the function button
  - An enlarged image section appears. The position of the enlargement depends on the position of the AF frame.
  - The rectangle within the frame at the top right represents the current magnification, as well as its position in the displayed cropped section.

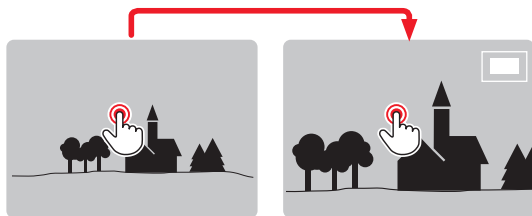

#### Adjusting the enlargement function

- ▶ Turn the thumbwheel
  - The image section toggles between magnification factors.

#### Changing the position of the enlarged section

- ▶ Press the joystick in the relevant direction

#### Exiting the enlargement function

- ▶ Tap the shutter button

or

- ▶ Press the function button again

#### Notes

- The enlargement function remains active until it is exited.
- The most recently magnification function will still be active the next time the feature is accessed.

### AF ASSIST LAMP

The AF assist lamp is not active in video mode.

### ACOUSTIC AF CONFIRMATION

You can set an acoustic confirmation signal for successful focus metering in AF mode (see p. 90).

#### Note

- This function is unavailable while recording.



## SHIFTING THE AF FRAME

All AF metering methods permit shifting the AF frame before focusing.

- ▶ Press the joystick in the relevant direction

or

- ▶ Tap the LCD panel in the desired position  
(While Touch AF is activated)

### Notes

- The focus frame will remain at the most recently used position for this AF metering method even if the user changes the AF metering method or the camera is switched off.
- The metering fields are joined together when the exposure metering method **Spot** is combined with the AF metering methods **Spot**, **Field** and **Zone**. Exposure metering will then occur at the point specified by the AF frame, even if it is moved.

## MANUAL FOCUSING (MF)

Manual focusing offers more control and is less prone to incorrect settings than the AF modes.

- ▶ Select **Focus Mode** in the main menu
- ▶ Select **MF**
  
- ▶ Start video recording
- ▶ Turn the focus ring to select the desired focusing





## MF ASSIST FUNCTIONS

The following assist functions are available in MF mode.

### FOCUS PEAKING

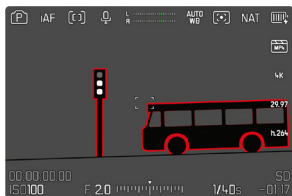
This assist function highlights the edges of in focus subject elements in color.



When Focus Peaking is activated,  will appear to the right of the frame with a display of the color used. The color can be user-specified. The sensitivity can be additionally adjusted. The activation of this function is controlled vis the info profiles (see p. 222).

- ▶ Activate the function
- ▶ Turn the focus ring to mark the desired subject elements

#### Note

- Focus peaking is based on subject contrast, i.e. differences between light and dark. As a result, high contrast subject elements could be marked, even if they are not completely in focus.

## ENLARGEMENT IN MF MODE

The larger the details of the object are shown, the better you can assess their sharpness and the more accurately you can focus.

This function can be automatically activated during manual focusing or can be accessed independently.

### ACCESS VIA THE FOCUS RING

Turning the focus ring will automatically enlarge a image section.

- ▶ Select **Focus Settings** in the main menu
- ▶ Select **Auto Magnification**
- ▶ Select **On**
- ▶ Turn the focus ring
  - An enlarged image section appears. The position of the enlargement depends on the position of the AF frame.
  - The rectangle within the frame at the top right represents the current magnification, as well as its position in the displayed cropped section.
  - The enlargement starts at the 1st of 3 enlargement increments.

### Adjusting the enlargement function

- ▶ Turn the thumbwheel/right dial

### Changing the position of the enlarged section

- ▶ Move the position of an enlarged cropped section by swiping or
- ▶ Press the joystick in the relevant direction



## Exiting the enlargement function

- ▶ Tap the shutter button

or

- ▶ Decrease the enlargement, until the full image is visible again

### Notes

- The magnification will automatically return to normal viewing size about 5 s after the last movement of the focus ring.
- This function is unavailable while recording.

### ACCESS VIA THE FUNCTION BUTTON

This function can be assigned to a function button.

### Assigning a function to one of the function buttons

- ▶ See p. 76

## Accessing the enlargement function

- ▶ Press the function button
  - An enlarged image section appears. The position of the enlargement depends on the position of the AF frame.
  - The rectangle within the frame at the top right represents the current magnification, as well as its position in the displayed cropped section.
  - The enlargement starts at the 1st of 3 enlargement increments.

## Adjusting the enlargement function

- ▶ Turn the thumbwheel/right dial

## Changing the position of the enlarged section

- ▶ Move the position of an enlarged cropped section by swiping

or

- ▶ Press the joystick in the relevant direction

### Exiting the enlargement function

- ▶ Tap the shutter button

### Note

- The enlargement function remains active until it is exited.

## DISTANCE DISPLAY

Distance information is shown in the top display during manual focusing.

- Focus Mode MF: when the shutter button is pressed to the first pressure point
- Focus Mode AF: when the shutter button is pressed and held at the first pressure point, followed by a turning of the focus ring

The unit of measure (m or ft) can be selected, see p. 85.

### Note

- The focus distance is estimated based on the focus position transmitted by the lens.

## FOLLOW FOCUS

This function facilitates automatic transitions to specified focus settings (focus positions). Up to three such focus positions can be pre-configured and optionally be set up with a delay time. When a focus position is accessed, the camera will automatically focus on the set distance. The transition will then be achieved smoothly and with a configurable speed. That way, soft, almost unnoticeable transitions are created. Prerequisite is that the relevant distances are known beforehand.

The specified focus positions can be accessed individually or in an automated sequence.

- ▶ Select **Focus Mode** in the main menu
- ▶ Select **Follow Focus**
- ▶ Select **Focus Position**
  - “Follow Focus” is activated. The Follow Focus menu appears.

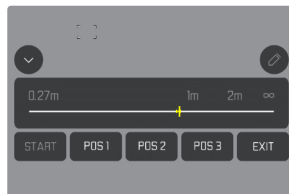

- The Follow Focus menu remains visible until the function is exited.

## FUNCTION BEHAVIOR

The function continues to run regardless of whether the camera is currently recording. All operating procedures described in the following can therefore also occur while actively recording. It is also possible to start and stop a recording during an active focus sequence, or to exit the Follow Focus menu while recording.

### Notes

- The following limitations apply while the function is active:
  - Depending on their assignments, some function buttons may be unavailable.
  - EVF is unavailable.
- **Follow Focus** is not available under the following conditions:
  - Recordings in slow motion
  - When using a lens adapter
  - When using MF lenses
  - When using lenses with AF/MF switch if the MF setting is selected

## FOLLOW FOCUS MENU

All operation is done via touch control only.

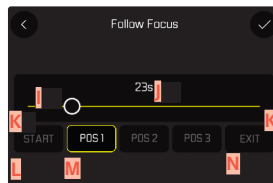
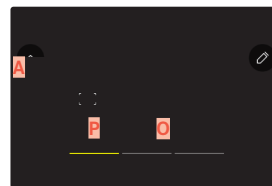
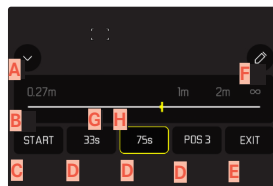

- A** Button for expanding/reducing the Follow Focus menu
- B** Focus position settings bar (Sharp focus in m or ft)
- C** "START" button (initiates the automatic focus sequence)
- D** Focus positions
- E** "EXIT" button (exits the Follow Focus menu)
- F** "Edit" button (only for pre-configured focus positions)
- G** Display of the set distance
- H** Display of the distance range in clear focus (Depth of field range, depending on the in-focus distance and the exposure value)
- I** Delay time settings bar
- J** Set delay time
- L** "Back" button
- M** Currently selected focus position
- N** "Confirm" button
- O** Running delay time
- P** Currently set focus position

The Follow Focus menu can be reduced to essential elements for better visibility.

- ▶ Tap button **A**
  - The Follow Focus menu toggles between full and reduced view.

#### Note

- Focus positions cannot be selected directly in reduced view.

## PREPARATION

### CONFIGURING A FOCUS POSITION

- ▶ Tap the desired focus position
  - The delay time settings menu appears.

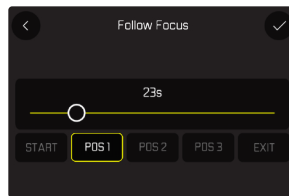

#### Setting a delay time

Delay times up to 120 s can be set (default setting is 0 s).

- ▶ Tap the desired setting directly via the settings bar
  - The selected time is displayed above the settings bar.
- ▶ Tap the “Confirm” button
  - The distance settings menu appears.



## Setting the distance

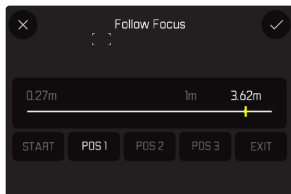

- ▶ Select the desired distance
  - Focusing can be done manually or via AFs (joystick/Touch AF). The shutter button remains locked.
  - The settings bar displays the set distance.
- ▶ Tap the “Confirm” button
  - The display returns to the top level of the Follow Focus menu.



- The settings bar displays the set distance.
- The set delay time is displayed instead of **POS 1**, **POS 2** or **POS 3**.

## Canceling the setting

- ▶ Tap the “Back” button
  - The display reverts to the previous menu level.

## CHANGING THE FOCUS POSITION

- ▶ Tap the desired button
  - The “Edit” button appears.

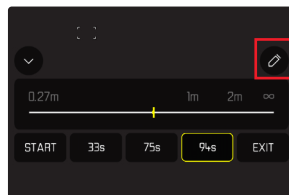

- ▶ Tap the “Edit” button
  - Any running delay time or focus setting is canceled.
  - The delay time settings menu appears.
- ▶ Define a new focus position

## USE

The **Follow Focus** function can be utilized in two ways.

- The pre-configured focus positions are accessed individually as needed.
- All configured focus positions are selected automatically in sequence.

Both methods can also be combined.

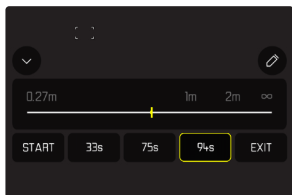

## ACCESS AS NEEDED

The configured focus positions can be accessed any number of times.

With delay time:

- The active delay time is displayed in Yellow and counts down.
- After that, the transition to the next desired focus position begins.

Without delay time:

- The transition to the next desired focus position is immediate.
- ▶ Tap the desired focus position
  - The camera focuses with the set speed on the configured distance (once the delay time has elapsed - if set).



## Note

- The transition to a focus position can be canceled via the “STOP” button, as long as it is not yet completed.





## AUTOMATIC SEQUENCE

An automatic sequence of focus positions can be initiated if at least two positions have been configured.

### START

- ▶ Configure at least two focus positions
- ▶ Tap the “START” button
  - The “START” button becomes “STOP” for the duration of the sequence.
  - All configured focus positions will be accessed in sequence (once the set delay time has elapsed - if any).
  - All other buttons are deactivated while the focus sequence runs.



### Note

- The automatic focus sequence can be run any number of times. The focus sequence will automatically revert to the first position when it is restarted.

### CANCEL

- ▶ Tap the “STOP” button
  - The running focus sequence is canceled.

### Initiating the automatic focus sequence directly at the beginning of the recording

The automatic focus sequence can be initiated directly at the beginning of the recording.

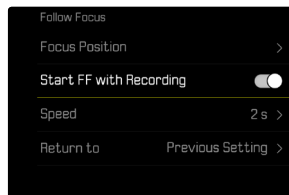

- ▶ Select **Focus Mode** in the main menu
- ▶ Select **Follow Focus**
- ▶ Select **Start FF with Recording**
- ▶ Select **On**

### Exiting the function

- ▶ Canceling a running sequence
- ▶ Tap the “EXIT” button
  - The “EXIT” button is unavailable while a focus sequence is running.



## OTHER SETTINGS

### SPEED

The speed at which one focus position transitions to the next can be configured. This setting will then apply for all transitions.

Factory setting: 2 s

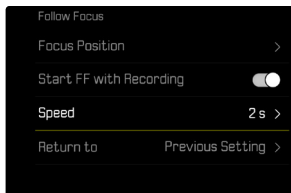

- ▶ Select **Focusing** in the main menu
- ▶ Select **Focus Mode**
- ▶ Select **Follow Focus**
- ▶ Select **Speed**
- ▶ Select the desired setting  
(10 s, 4 s, 2 s, 1 s, 1/2 s)

## SUBSEQUENT FOCUS MODE

After exiting, you can switch automatically to a pre-configured focus mode (e.g. **MF**) or to the most recently used focus mode.

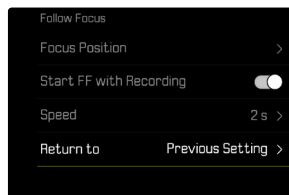

- ▶ Select **Focusing** in the main menu
- ▶ Select **Focus Mode**
- ▶ Select **Follow Focus**
- ▶ Select **Return to**
- ▶ Select the desired setting  
(**Intelligent AF**, **AFs**, **AFc**, **MF**, **Previous setting**)



## ISO SENSITIVITY

### (Video mode)

The ISO setting covers a range between ISO 50 and ISO 100,000, allowing you to adapt to the relevant situation as required.

There is more leeway for the use of preferred shutter-speed/aperture combinations when choosing an automatic ISO setting. You can set priorities within the scope of the automatic setting.

Factory setting: **ISO 100**

### FIXED ISO VALUES

The user can select ISO values between 50 and 100,000. Manual ISO setting occurs in increments of 1/2 EV, 1/3 EV, or 1/6 EV, depending on the selected **ISO Increment** setting. The number of available ISO values depends on the selected **ISO Increment** (under the menu item **ISO Settings**).

#### Using the dial

Factory setting: Left Dial

- ▶ Turn the left setting wheel
  - The ISO value display changes accordingly in the top display and on screen.

#### Via the Control Center

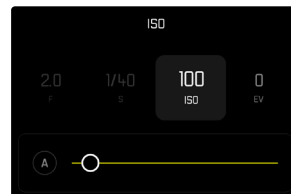
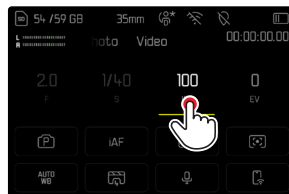

#### Using the function buttons

- ▶ Press and hold the desired function button
- ▶ Select **ISO**
- ▶ Select the desired setting

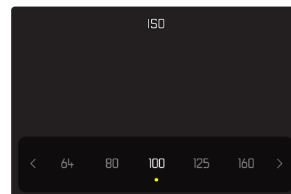
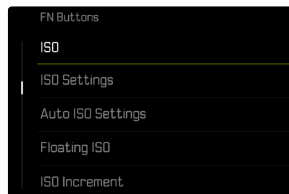

#### Note

- When high ISO values are used or the image is edited later, image noise, as well as vertical and horizontal stripes may become visible, particularly in larger, evenly lit areas of the object.

## AUTOMATIC SETTING

The camera automatically adjusts the sensitivity to ambient brightness and/or to the configured shutter-speed/aperture combination. In conjunction with aperture-priority mode, this function extends the range for automatic exposure control. The automatic setting of ISO sensitivity occurs in increments of 1/2 EV, 1/3 EV, or 1/6 EV, depending on the **ISO Increment** setting selected.

### Via the Control Center

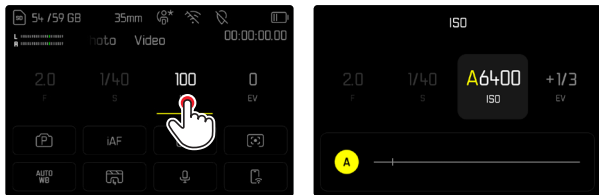

### Using the function buttons

- ▶ Press and hold the desired function button
- ▶ Select **ISO**
- ▶ Select the desired setting

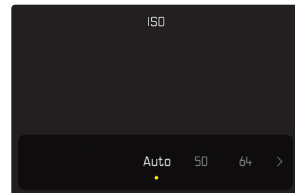
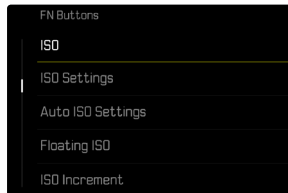

- ▶ Select **ISO** in the main menu
- ▶ Select **Auto ISO**

### Note

- This function is not available in Cine mode.



## LIMITING SETTING RANGES

A max. ISO value can be set, which will then limit the automatic setting range (**Max. ISO value**). A max. exposure time can also optionally be configured. There are automatic settings and fixed max. shutter speeds **1/30**s and **1/2000**s available for that purpose.

### LIMITING ISO VALUES

All values from ISO 200 are available.

Factory setting: **6400**

- ▶ Select **ISO Settings** in the main menu
- ▶ Select **Auto ISO Settings**
- ▶ Select **Maximum ISO**
- ▶ Select the desired value

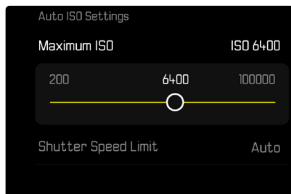

## LIMITING SHUTTER SPEED RANGES

Factory setting: **Auto**

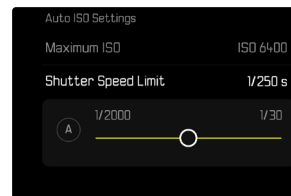
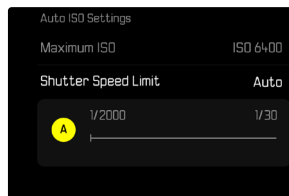

- ▶ Select **Auto ISO Settings** in the main menu
- ▶ Select **Shutter Speed Limit**
- ▶ Select the desired value  
(**Auto**, **1/2000**, **1/1000**, **1/500**, **1/250**, **1/125**, **1/60**, **1/30**)

## DYNAMIC ISO SETTING

The thumbwheel and right setting dial can be configured to allow manual ISO settings in real time. That is the factory setting in the operating modes **S**, **A** and **M**. Turning the dial will cycle through all setting values available in the **ISO** menu. That means that **Auto ISO** can also be selected.

## FLOATING ISO

This function complements Auto ISO. Light strength changes with many zoom lenses when the focal length is changed. Floating ISO will in this situation adjust the sensitivity in fine graduations and will simultaneously ensure that the selected settings of aperture value and shutter speed remain constant in (semi) automatic exposure modes. This will specifically in video shootings prevent visible jumps in brightness.

Factory setting: **On**

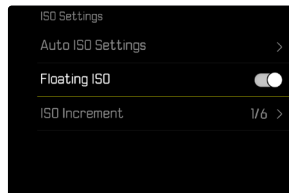

- ▶ Select **Floating ISO** in the main menu
- ▶ Select **On**

### Notes

- **Floating ISO** can work only if the original ISO setting allows scope for change, i.e. the highest/lowest ISO setting is not already being used. The **Floating ISO** warning icon will be displayed in that case.
- This function is not available in Cine mode.



## ASA SENSITIVITY (Cine-Mode)

The sensitivity setting in Cine mode is always done manually. The menu item **Exposure Index** replaces the menu item **ISO**. The value is stated in ASA units. Automatic settings (Auto ISO/Floating ISO) are unavailable.

Factory setting: **100 ASA**

### Via the Control Center

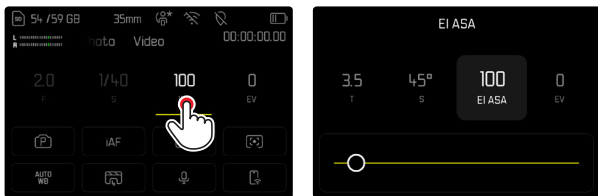

### Using the function buttons

- ▶ Press and hold the desired function button
- ▶ Select **ASA**
- ▶ Select the desired setting

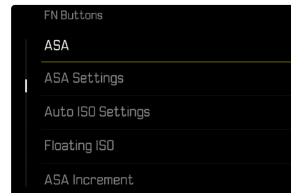
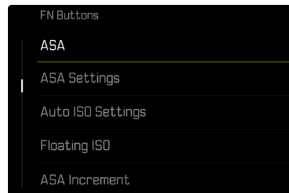

- ▶ Select **ASA** in the main menu
- ▶ Select the desired setting

## WHITE BALANCE

In digital photography, White Balance ensures neutral color rendering in any light. White Balance relies on the setting made in the camera, which light color is to be rendered as 'white'.

Four methods are available:





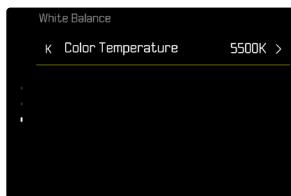
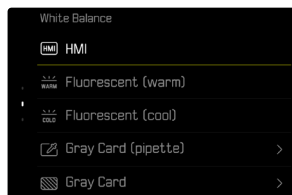
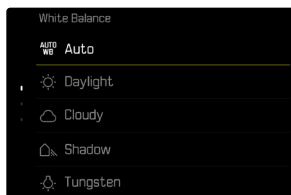

- automatic control
- fixed presets
- manual setting via metering
- direct setting of the color temperature

Factory setting: **Auto**



## AUTOMATIC CONTROL/FIXED SETTINGS

- **Auto**: for automatic control, which delivers neutral results in most situations
- Various fixed presets for most frequently encountered light sources:



	<b>Daylight</b>	For outdoor shootings in sunlight
	<b>Cloudy</b>	For outdoor shootings in cloudy conditions
	<b>Shadow</b>	For outdoor shootings with the main subject in shadow
	<b>Tungsten</b>	For indoor shootings with (predominantly) incandescent lamp light
	<b>HMI</b>	For indoor shootings with (predominantly) light from metal halide lamps
	<b>Fluorescent (warm)</b>	For indoor shootings with (prevailing) light from fluorescent tubes with warm light color
	<b>Fluorescent (cool)</b>	For indoor shootings with (prevailing) light from fluorescent tubes with cool light color

- ▶ Select **White Balance** in the main menu
- ▶ Select the desired setting



## MANUAL SETTING VIA METERING

( Gray Card /  Gray Card (pipette))

This metering variant captures all color hues in the metering field and uses these to calculate a mean gray value. The variant  Gray Card is suited best for subjects in which you can clearly identify a neutral gray or pure white area. If that is not the case, or should you wish to base your metering on an off-center detail, then  Gray Card (pipette) will be a better choice.

### Note

- A value configured using this method will remain unchanged (i.e. it will be used for all subsequent photographs) until new measurements are taken or one of the other white balance settings is selected.

## GRAY CARD (PIPETTE)

This metering variant captures only the color hue metered within the metering field and calculates the mean gray value from it.

- ▶ Select **White Balance** in the main menu
- ▶ Select **Gray Card (pipette)**
  - The following appears on the LCD panel:
    - the image based on automatic white balance
    - a cross in the middle of the image



- ▶ Aim the metering field at a white or neutral gray area

### Repositioning the focus frame

- ▶ Press the joystick in the relevant direction

### Performing measurement

- ▶ Shutter release

or

- ▶ Press the joystick/thumbwheel
  - The measurement is taken.

### Cancelling measurements

- ▶ Press the **FN** button



## GRAY CARD

This metering variant captures all color hues in the metering field and uses these to calculate a mean gray value.

- ▶ Select **White Balance** in the main menu
- ▶ Select **Gray Card**
  - The following appears on the LCD panel:
    - the image based on automatic white balance
    - a frame in the center of the image

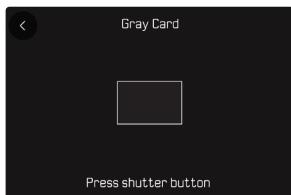

- ▶ Aim the metering field at a white or neutral gray area
  - The screen image changes dynamically in line with the reference area in the frame.

## Performing measurement

- ▶ Shutter release

or

- ▶ Press the joystick/thumbwheel
  - The measurement is taken.

## Cancelling measurements

- ▶ Press the **FN** button

## DIRECT SETTING OF THE COLOR TEMPERATURE

Values between 2000 and 11500 K (Kelvin) can be set directly. That gives you a very wide range, which covers virtually all color temperatures occurring in real life and within which you can adapt color rendering to any light color and your personal preferences with incredible detail.

Factory setting: **5500 K**



- ▶ Select **White Balance** in the main menu
- ▶ Select **Color Temperature**
- ▶ Select the desired value



## EXPOSURE

The exposure setting is done dynamically via the two assigned dials. Function assignments can be modified, see p. 77.

Exposure settings can be done quickly and easily via the Control Center.

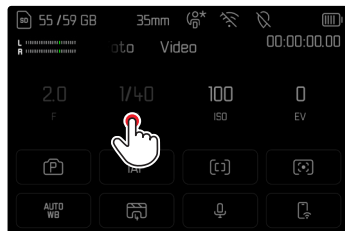

- ▶ Tap the desired control panel
  - The active control panel is highlighted in gray.
  - A setting band appears instead of the menu items. A dot marks the current setting. The current setting value is displayed above the dot.
- ▶ Tap the setting band briefly in the desired position, or drag the dot to the desired position

## EXPOSURE METERING METHODS

The following exposure metering methods are selectable. Factory setting: **Multi-Field**

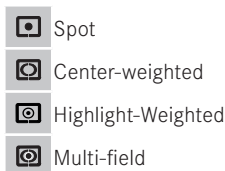

- ▶ Select **Exposure Metering** in the main menu
- ▶ Select the desired metering method (**Spot**, **Center-Weighted**, **Highlight-Weighted**, **Multi-Field**)
  - The selected metering method is displayed in the header line of the screen image.

Spot metering allows a shifting of the focus point:

- ▶ Press the joystick in the relevant direction

### Notes

- The exposure information (ISO value, aperture, shutter speed and light balance with exposure compensation scale) will help to determine the settings required for correct exposure.
- The most important displays (ISO value, aperture and shutter speed) will also appear in the top display.



## SPOT

This metering method is concentrated exclusively on a small area in the center of the image. The metering fields are joined together when the exposure metering method **Spot** is combined with the AF metering methods **Spot**, **Field** and **Zone**. Exposure metering will then occur at the point specified by the AF frame, even if it is moved.

## CENTER-WEIGHTED



This method considers the entire image field. The subject elements captured in the center will, however, impact on the calculation of the exposure value more so than areas around the edges.

## MULTI-FIELD

This metering method is based on the detection of multiple values. These values are used in an algorithm to calculate an exposure value appropriate for a good rendering of the assumed main subject.

## HIGHLIGHT-WEIGHTED

This method considers the entire image field. The exposure value will, however, be adjusted to very bright subject elements. That prevents the overexposure of bright subject elements without having to measure them individually. This metering method is particularly useful for objects that are significantly more brightly lit than the rest of the frame (e.g. people in a spotlight), or that reflect the light significantly (e.g. white clothing).

Multi-field	Highlight-weighted
	
	
	



## EXPOSURE MODES

You can choose one of four video shooting modes:

- Program AE mode (**P**)
- Aperture-priority mode (**A**)
- Shutter-priority mode (**S**)
- Manual setting (**M**)

Cine mode also offers another, fully manual mode.

### Notes

- When using a lens with an aperture ring (e.g. Leica M lenses), only the exposure modes **A** (aperture-priority) and **M** (manual setting) will be available. Where that is the case, **F0.0** is displayed as the aperture value.
- The following applies for all exposure modes: the available shutter speeds for custom settings or those available for automatic settings depend on the selected frame rate ([Video Resolution](#), see p. 197).
- When Auto ISO is active, the camera uses the dynamic adjustment function for the ISO value for the exposure setting. Depending on the exposure mode selected, the automatic ISO setting interacts with automatically controlled aperture and/or shutter speed settings.

## SELECTING A MODE

### Via the thumbwheel

- ▶ Press the thumbwheel
  - The currently selected mode is shown in the top display. The currently selected mode is marked in red on screen.
- ▶ Turn the thumbwheel to select the desired mode
  - The mode display changes in the top display and on screen. All modes can be reached by turning the wheel in either direction.
  - The selected mode will be applied automatically approx. 2 s after the thumbwheel is moved the last time.



### Applying the selected mode immediately

- ▶ Press the joystick/thumbwheel
- or
- ▶ Tap the shutter button

## Via the Control Center

- ▶ Tap the control panel

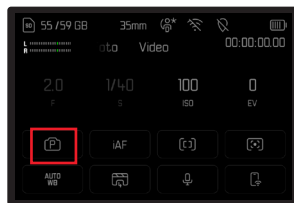

- ▶ Tap the desired exposure mode

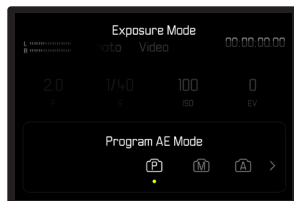

## FULLY AUTOMATIC EXPOSURE SETTING – P

### PROGRAM AE MODE – P

The exposure is controlled by an automatic shutter speed and aperture setting.

The exposure compensation and recording level are controlled directly via the setting wheels.



- ▶ Select the operating mode **P** (see p. 268)
- ▶ Set exposure compensation as needed
- ▶ Start video recording

### Note

- Automatic exposure control takes into account any fluctuations in brightness. Set the shutter speed manually if this is undesirable, e.g. for landscape recordings or panning.



## SEMI-AUTOMATIC EXPOSURE SETTING – A/S

### APERTURE-PRIORITY MODE- A

Aperture-priority mode sets the exposure automatically according to the manually selected aperture. It is therefore specifically suitable for video recordings in which the depth of field is a critical compositional element.

The range of the depth of field can be diminished with an accordingly small aperture value. This will set off the focused area against the unfocused background. Conversely, a greater aperture value will increase the range of the depth of field. Such a setting is advisable if the foreground and background should be rendered in sharp focus. The selected aperture setting will be maintained for the duration of the recording.

- ▶ Select the operating mode **A** (see p. 268)
- ▶ Set the desired aperture value
- ▶ Start video recording

### SHUTTER-PRIORITY MODE – S

Shutter-priority mode will set exposure automatically according to the manually selected shutter speed. The selected shutter speed will be maintained for the duration of the recording.



- ▶ Select the operating mode **S** (see p. 268)
- ▶ Set the desired shutter speed
- ▶ Start video recording

## MANUAL EXPOSURE SETTING – M

The following manual settings for shutter speed and aperture are a good choice:

- to maintain constant exposure settings between multiple recordings
- to maintain constant exposure settings while recording, specifically in conjunction with fixed ISO settings
- ▶ Select the operating mode **M** (see p. 268)
- ▶ Select desired exposure
  - The exposure compensation is done using the scale of the light balance.
- ▶ Start video recording

Displays on the light balance:

	Correct exposure
	Underexposure or overexposure by the displayed value
	Underexposure or overexposure by more than 3EV (Exposure Value)

## EXPOSURE COMPENSATION

Exposure compensation values can be set in the range  $\pm 3$  EV (EV: Exposure Value). The available values depend on the global setting **EV Increment** (see p. 220).

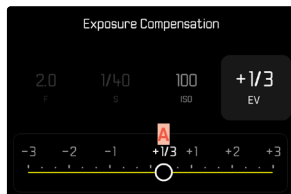

**A** Set compensation value (marks at 0 = Off)

- ▶ Select **Exposure Compensation** in the main menu
  - A scale appears as a submenu item on the LCD panel.
- ▶ Set the value on the scale
  - The set value is displayed above the scale.
  - While setting the value, you can see the effect on the screen image, which becomes darker or lighter.

## Notes

- This function is assigned to one of the setting wheels in the three (semi) automatic exposure modes and therefore quickly accessible (see p. 77).
- The set exposure compensation is indicated by a mark on the exposure compensation scale in the footer line (see p. 32).
- The following applies for set compensation values, no matter how they were initially set: They remain effective until they are manually reset to 0, even if the camera is switched off and on again in the meantime.
- Changes to the **EV Increment** setting (see p. 220) lead to the cancellation of a compensation that has been set, i.e. in such cases it is automatically reset to 0.



## PLAYBACK MODE

Playback mode is used to display and manage the stored recordings. The switchover between shooting and playback mode, as well as most other actions can be completed using gesture or key control. Please see p. 61 for more information about the available gestures.

### Notes

- Recorded videos are not automatically rotated in playback mode to utilize the full screen area.
- It may not be possible to render files with this camera that were not recorded with this device.
- In some cases, the screen image may not have the expected quality, or the LCD panel will remain blank and only display the file name.
- You can toggle back from playback mode to shooting mode at any time by tapping the shutter button.

## CONTROL ELEMENTS IN PLAYBACK MODE

### CONTROL ELEMENTS ON THE CAMERA

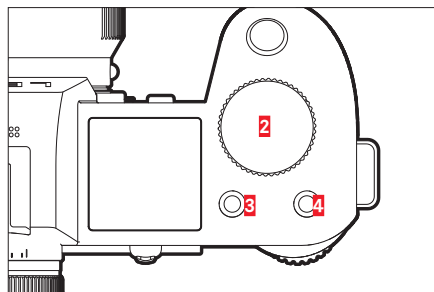
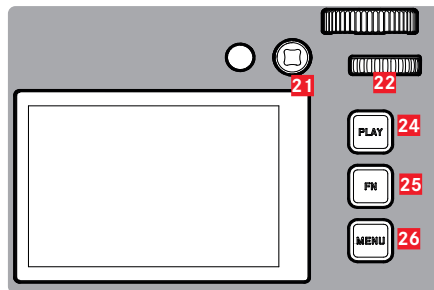

- |                          |                                      |
|--------------------------|--------------------------------------|
| <b>2</b> Right dial      | <b>22</b> Thumbwheel (turn or press) |
| <b>3</b> Function button | <b>24</b> <b>PLAY</b> button         |
| <b>4</b> Function button | <b>25</b> <b>FN</b> button           |
| <b>21</b> Joystick       | <b>26</b> <b>MENU</b> button         |



## DIRECT ACCESS IN PLAYBACK MODE

The function buttons can have individual assignments in playback mode as well.

In factory settings, the function buttons have the following assignments:

Button	Function
Right dial	Magnification
Function button <b>3</b>	Delete Single
Function button <b>4</b>	Mark shots (Rate / Unrate)
FN button	Toggle Info Levels

The descriptions in the next few sections presume factory settings.

### Note

- The assigned function is independent of the current display mode; the delete functions overview can therefore be accessed directly in full screen display mode.
- The assigned function is unavailable if the function button addresses an on-screen control element (e.g. in the “Delete” screen).

## CONTROL ELEMENTS ON THE LCD PANEL

On-screen control elements generally function by intuitively by touch. Many can also be selected by pressing one of the three buttons to the right of the LCD panel (**PLAY** button, center button, **MENU** button). A control element in the header is accompanied by an icon denoting the relevant button. A control element on the edge of the screen will be positioned directly next to the relevant button.

You have e.g. two options to select the Favorites icon ★:

- Tap on the Favorites icon directly
- Press the relevant button  
(Factory setting: Function button **4**)

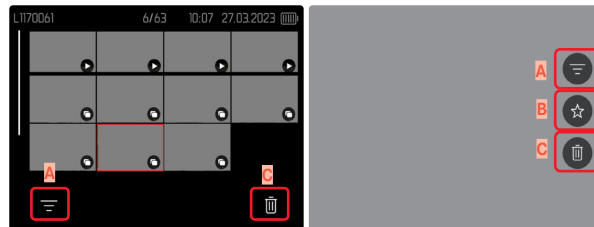

- A** Control element “Filter”
- B** Control element “Favorites”
- C** Control element “Delete”



## INITIATE/EXIT PLAYBACK MODE

### Using touch control

- ▶ Swipe down

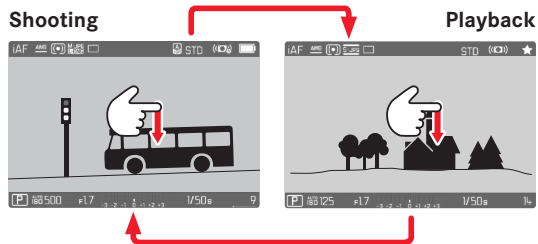

### Using button control

- ▶ Press the **PLAY** button
  - The last image taken appears on the screen.
  - The following message appears if the inserted memory card does not contain any image data: **No valid picture to play.**
  - The **PLAY** button function differs, depending on the current camera setting

Initial situation	After pressing the PLAY button
Full screen display of an image	Shooting mode
Display of an enlarged cropped section/or several thumbnails	Full screen display of the image

## SELECTING/SCROLLING THROUGH IMAGES

The images are visually arranged in a horizontal reel. The sorting will be strictly chronological. When the end of an image series is reached, the display automatically jumps back to the first image in the series. All images can therefore be reached by scrolling either right or left.

### SINGLE

#### Using touch control

- ▶ Swipe to the left or right

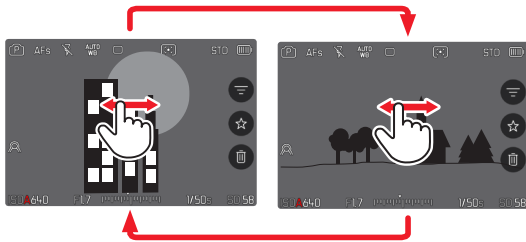

#### Using button control

- ▶ Press the joystick left/right
- or
- ▶ Turn the thumbwheel

## CONTINUOUS

- ▶ Swipe to the left or right and hold the finger on the edge of the screen
  - The subsequent shots will move past continuously.



## STORAGE LOCATIONS

Leica SL3 offers with two separate storage locations.

When review mode is accessed, the last captured image will always be displayed first. That also applies on the storage location displayed first.

When scrolling through images and also in the overview, the images saved to the same storage location are available first.



### Switching the displayed storage location

- ▶ Reduce the view as much as possible (see p. 79)
  - The storage location selection view appears.
  - The currently selected storage location is displayed with a color fill.



- ▶ Press the directional pad left/right
  - The newly selected storage location appears with a color frame.
- ▶ Press the center button
- ▶ Re-enlarge the view

## INFO DISPLAYS IN PLAYBACK MODE

The same info profiles are available in playback mode as in shooting mode. The actual info profile currently in use, however, is saved separately. It is therefore possible to use an empty info profile completely without assist function icons in playback mode, without having to set them again when switching to shooting mode. See p. 115 for setting options and additional information. The assist functions **Grid**, **Level Gauge**, **Framelines**, or **Waveform Monitor** are not available in review mode.

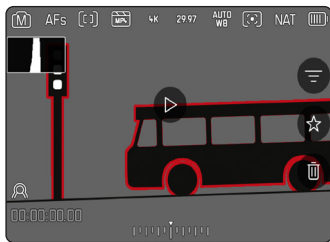

### Switching between info profiles

- ▶ Press the **FN** button
  - The info bars appear (header and footer line always appear/disappear together in review mode).
  - Where the options **Histogram** (**Luminance** only) and **Clipping** are selected, these displays will also be visible.



Info Bars



Empty info profile

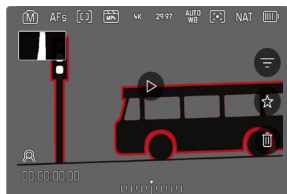

Info Bars, Focus Peaking,  
Histogram



Info Bars, file information



## DISPLAYING MULTIPLE IMAGES AT ONCE

The camera offers an overview function in which several thumbnail images can be viewed on one screen, which makes it easier to find a specific image. Choose to display 9 or 16 thumbnails for your overview.

### OVERVIEW

#### Using touch control

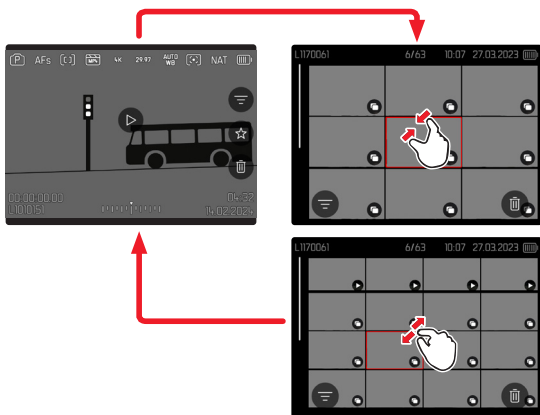

- ▶ Two-finger pinch
  - The display toggles between 9 or 16 thumbnails.

#### Viewing other images

- ▶ Swipe up or down

#### Using button control

- ▶ Turn the right dial in anti-clockwise direction
  - An overview with 9 thumbnails is displayed. Another turn on the dial increases the number of displayed thumbnails to 16.

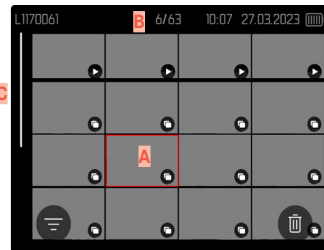
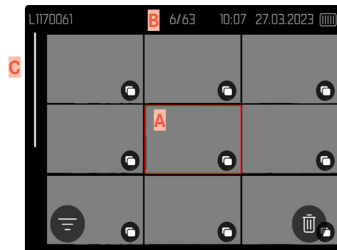

- A** Currently selected image
- B** Number of the currently selected images
- C** Scrollbar

The currently viewed image is framed in red and can be selected for a closer look.

## Navigating between images

- ▶ Press the joystick in the relevant direction
- or
- ▶ Turn the thumbwheel

## Displaying the recording in full size

### Using touch control

- ▶ Two-finger spread
- or
- ▶ Tap the desired image

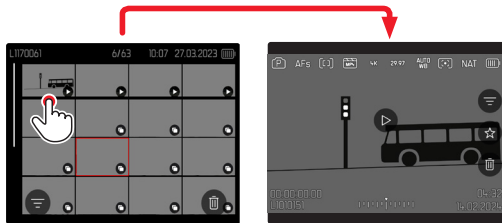

### Using button control

- ▶ Turn the right dial in clockwise direction
- or
- ▶ Press joystick, thumbwheel or **PLAY** button

## TAGGING/RATING OF RECORDINGS

Images can be marked as favorites to find them quicker or to simplify the later deletion of multiple images. Tagging can be done in regular view mode or in the overviews.

### Tagging a recording

- ▶ Press the function button **4**
- or

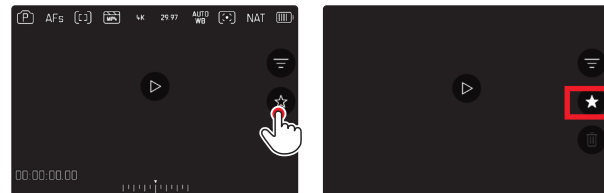

- ▶ Tap the ★ icon
  - The ★ icon is highlighted.
  - The icon will appear in the header on the far right when viewing images in full size, and in the lower left corner of the thumbnail overview.

### Removing a tag

- ▶ Press the function button **14**
- or
- ▶ Tap the ★ icon



## DELETING RECORDINGS

There are several methods available to delete recordings:

- deleting individual recordings
- deleting multiple recordings
- deleting all recordings without a icon/ranking
- deleting all recordings

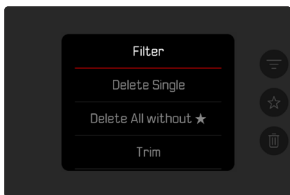

### Important

- Once deleted, images are no longer retrievable.

## DELETING INDIVIDUAL RECORDINGS



- ▶ Tap the Delete  icon
  - The recording will be deleted without additional confirmation prompt.
  - The LED will flash during the delete process. The process may take a few seconds.
  - The next image will be displayed once deletion is complete. The following message appears if no other recordings are saved on the card: **No valid picture to play.**

or

- ▶ Press the function button 
  - The Delete screen appears.

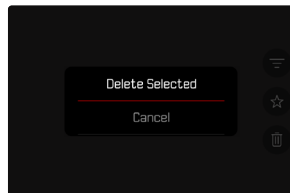



## Cancelling a deletion and return to the normal playback mode

- ▶ Press the **PLAY** button

### Notes

- The Delete screen can be called up only by pressing the **MENU** button when in overview mode, because the menu function **Delete** of the “Play menu” is not available in this context.
- The “Scroll” and “Magnify” functions will always be available, even if the “Delete” screen is active.

## DELETING MULTIPLE RECORDINGS

You can highlight multiple images in a Delete overview with twelve thumbnails for simultaneous deletion.

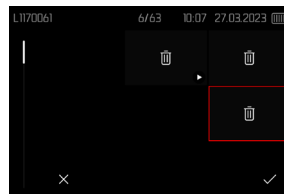

- ▶ Turn the right dial to the left
  - The overview screen appears.
- ▶ Press the **MENU** button
- ▶ Select **Delete Multi**
  - The Delete overview appears.



Any number of recordings can be selected in this view.

### Selecting recordings for deletion

- ▶ Select an image
- ▶ Press the joystick/thumbwheel

or

- ▶ Tap the desired image
  - The images selected for deletion are marked with a red Delete icon .

### Deleting the selected recordings

- ▶ Press the **MENU** button

or

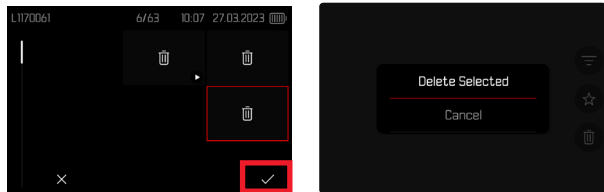

- ▶ Tap the “Confirm” icon
- ▶ Select **Delete Selected**
  - The images selected for deletion are marked with a red Delete icon .

### Cancelling a deletion and return to the normal playback mode

- ▶ Press the **MENU** button

## DELETING ALL UNRATED IMAGES

- ▶ Press the **MENU** button
- ▶ Select **Delete All without ★**

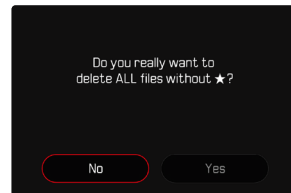
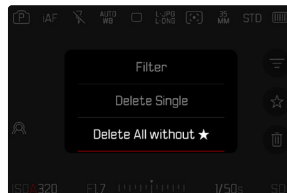

- The confirmation prompt **Do you really want to delete ALL files without ★?** appears.
- ▶ Select **Yes**
  - The LED will flash during the deletion process. The process may take a few seconds. The next marked image appears once deletion is complete. The message **No valid picture to play.** appears if no other recordings are saved on the card.





## PAUSE PLAYBACK

- ▶ Tap anywhere on the LCD panel
- or
- ▶ Press the joystick/thumbwheel

## RESUMING PLAYBACK

### Using touch control

While the control elements are visible:

- ▶ Tap anywhere on the LCD panel

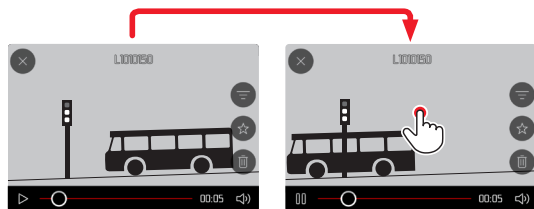

### Using button control

While the control elements are visible:

- ▶ Press the joystick/thumbwheel

## NAVIGATE TO ANY POINT IN THE FILE

### QUICK JUMP

#### Using touch control

While the control elements are visible:

- ▶ Tap the Playback status bar at the desired position

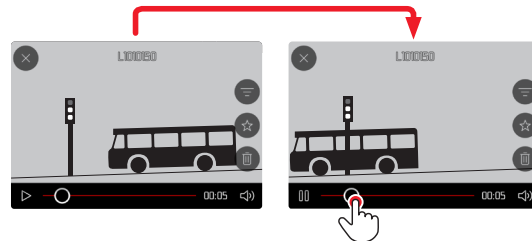

#### Using button control

- ▶ Press and hold the joystick left/right

## PRECISE SELECTION

- ▶ Turn the thumbwheel

## END PLAYBACK

### Using touch control

While the control elements are visible:

- ▶ Tap the “Go back” icon ↶

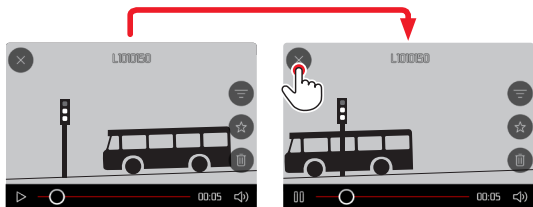

### Using button control

- ▶ Press the **PLAY** button

## SETTING THE VOLUME

### Using touch control

While the control elements are visible:

- ▶ Tap the volume icon
- ▶ Tap the volume bar at the desired position

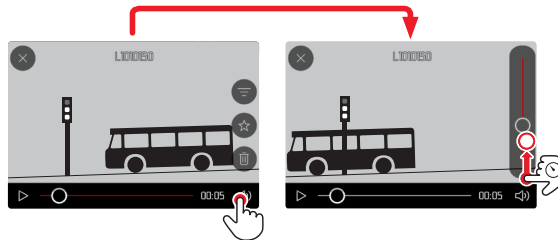

### Using button control

- ▶ Press the joystick up/down
  - The volume bar appears.
- ▶ Press the joystick up (louder) or down (quieter)

### Note

- Sound is switched off at the lowest part of the bar and the volume icon changes to .

## VIDEO EDITING

### Using button control

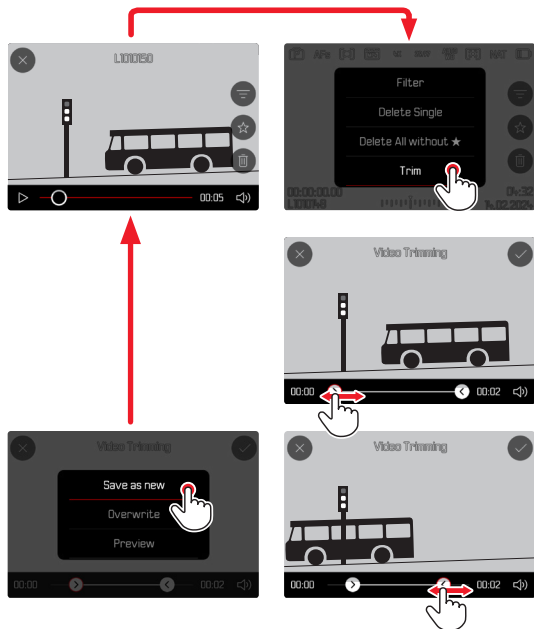

## ACCESSING THE VIDEO EDITING FUNCTION

- ▶ Press the **MENU** button
- ▶ Select **Video Trimming**
  - The video editing screen appears, the left cutting mark is highlighted in red (= active).

## CHANGING THE CURRENT CUTTING POINT

- ▶ Press the joystick left/right
  - The selected cutting point is highlighted in red (= active).

## MOVING THE ACTIVE CUTTING POINT

- ▶ Turn the thumbwheel
  - The currently selected time of the relevant cutting point is displayed at the bottom left of the footer line. A still of the video sequence at that point is displayed in the background.



## CUTTING

- ▶ Press the thumbwheel or the joystick to confirm the cuts
  - The **Video Trimming** menu appears.
- ▶ Select a function from the **Video Trimming** menu  
(**Save as new**, **Overwrite**, **Preview**)

<b>Save as new</b>	The new video is <u>additionally</u> saved, the original video remains unchanged.
<b>Overwrite</b>	The newly cut video is saved and the original one is deleted.
<b>Preview</b>	The new video is played. The newly cut video is not saved and the original remains unchanged.

## CANCELLING THE VIDEO EDITING FUNCTION

The editing function can be canceled at any time, provided no selection was made in the **Video Trimming** menu.

- ▶ Press the **PLAY** button
  - The video playback screen reappears.

## Notes

- In all three cases, a notification screen appears while the data is being processed. Then the new video is played back.
- The numbering of existing recordings will not be changed when **Save as new** is selected. The newly created video will be added to the end of the series of videos.



## OTHER FUNCTIONS

The settings described in this chapter apply for photo and video mode alike. They are therefore available in the picture and video menu (see chapter “Camera Operation” under “Menu Control”). A setting selected in one of the modes will also apply to the other.

## RESETTING THE CAMERA TO FACTORY SETTINGS

This function allows you to reset all your custom menu settings back to the factory settings. You can optionally exclude the user profiles, Wi-Fi and Bluetooth settings, as well as the image numbering from the reset individually.

- ▶ Select **Camera Settings** in the main menu
- ▶ Select **Reset Camera**
  - The prompt **Do you want to reset the camera settings?** appears.
- ▶ Confirm (**Yes**) or reject (**No**) restoring the default settings
  - Selecting **No** will cancel the reset and the display will return to the main menu. Selecting **Yes** will trigger additional prompts regarding the settings you can opt to keep.
- ▶ Confirm or reject the reset of the user profiles (**Yes**) / (**No**)
- ▶ Confirm or reject the reset of the Wi-Fi and Bluetooth settings (**Yes**) / (**No**)
- ▶ Confirm or reject the reset of the image numbering (**Yes**) / (**No**)
- ▶ Confirm or reject the reset of the LUT profiles (**Yes**) / (**No**)
- ▶ Confirm or reject the reset of the Leica Looks profiles (**Yes**) / (**No**)
  - The message **Please Restart the Camera** appears.
- ▶ Switch the camera off and on again





## Notes

- Date & time, as well as the preferred language will have to be set up again after a reset. Relevant prompts will appear on screen.
- You reset the image numbering separately via the menu item **Reset Image Numbering** (see p. 288).

## FIRMWARE UPDATES

Leica is continuously working on the further improvement and optimization of your camera. Since many camera functions are entirely controlled by software, some of these improvements and additions to the functional scope can be installed in retrospect. Leica offers firmware updates at irregular intervals, which you can download from our website.

Leica will notify you of any new updates, once you have registered your camera. Users of Leica FOTOS will also be automatically notified about firmware updates for their Leica cameras.

There are two options for installing firmware updates.

- conveniently via the Leica FOTOS app (see p. 294)
- directly via the camera menu



## Finding the currently installed firmware version

- ▶ Select **Camera Information** in the main menu
  - The current firmware version is displayed next to the menu item **Camera Firmware Version**.

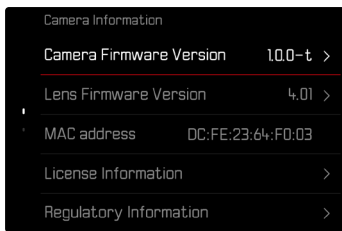

More information about registering, firmware updates and how to download them to your camera, as well as any amendments and additions to this manual can be found in the customer area of our website at:

<https://club.leica-camera.com>

## EXECUTING A FIRMWARE UPDATE

Any interruption of a running firmware update may cause serious and irreparable damage to your equipment!

You will therefore have to take particular note of the following, when carrying out a firmware update:

- Do not switch off the camera!
- Do not remove the memory card!
- Do not remove the rechargeable battery!
- Do not detach the lens!

### Notes

- A warning message will appear if the battery is insufficiently charged. Recharge the battery and then repeat the process described above.
- You will find additional device and country-specific registration marks and numbers in the **Camera Information** submenu.



## PREPARATION

- ▶ Fully charge and insert the rechargeable battery
- ▶ Remove the second card (where applicable) from the camera
- ▶ Any stored firmware files on the memory card must be removed
  - We recommend saving any images on the memory card and reformatting it before the update.  
(Caution: Loss of data! **All** data stored on the memory card will be lost during formatting.)
- ▶ Download the latest firmware version
- ▶ Save the download to the memory card
  - The firmware file must be stored in the main directory of the memory card (not in a sub-directory).
- ▶ Insert the memory card into the camera
- ▶ Switch the camera on

## UPDATING THE CAMERA FIRMWARE

- ▶ Preparation
- ▶ Select **Camera Information** in the main menu
- ▶ Select **Camera Firmware Version**
- ▶ Select **Firmware Update**
  - A prompt with information about the camera is displayed.
- ▶ Check the version information
- ▶ Select **Yes**
  - The prompt **Save profiles on SD Card?** appears.
- ▶ Select **Yes/No**
  - The update will start automatically.
  - The status LED will flash during this process.
  - Once the process has completed successfully, a relevant on-screen message and prompt to restart the device will appear on screen.
- ▶ Switch the camera off and on again

### Note

- Date & time, as well as the preferred language will have to be set up again after the restart. Relevant prompts will appear on screen.
- These settings will be applied automatically if the update is loaded via Leica FOTOS.



## UPDATING THE LENS FIRMWARE

Where available, you can optionally carry out firmware updates for lenses. The instructions provided for camera firmware updates apply.

- ▶ Preparation
- ▶ Select **Camera Information** in the main menu
- ▶ Select **Lens Firmware Version**
- ▶ Select **Firmware Update**
  - A prompt with information about the camera is displayed.
- ▶ Check the version information
- ▶ Select **Yes**
  - The update will start automatically.
  - The lower status LED will flash during this process.
  - Once the process has completed successfully, a relevant on-screen message and prompt to restart the device will appear on screen.
- ▶ Switch the camera off and on again





## LEICA FOTOS

The camera can be controlled remotely using a smartphone/tablet PC. This will require an installation of the Leica FOTOS app on the mobile device. Leica FOTOS furthermore offers a variety of other useful functions:

- Geotagging for images
- File transfer
- Downloading firmware updates
- Self-timer delay time selection via remote control, e.g. for group photographs
- Loading and transferring Leica Looks

A list of available functions and instructions for their use can be found in the Leica FOTOS app. Please read the legal notes on page 4.

- ▶ Scan the following QR code with the mobile device



or

- ▶ The app is available from Apple App Store™/Google Play Store™

## SELECTING A WI-FI BAND

Leica SL3 supports the use of various Wi-Fi frequencies in a number of regions.

- ▶ Select **Camera Settings** in the main menu
- ▶ Select **WLAN**
- ▶ Select **Wi-Fi band**
- ▶ Select the desired setting

### Note

- The menu item will appear grayed out, where this option is unavailable.

## CONNECTIVITY (iPhone users)

### FIRST-TIME CONNECTION TO A MOBILE DEVICE

The camera can be paired with a mobile device when the two devices connect for the first time.

### CONNECTION WIZARD

The connection wizard appears at initial startup of the camera or after a camera reset. These settings are also available via the menu item **Leica FOTOS**.

The following screen appears after you have selected the language.

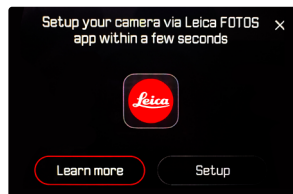

#### Starting the connection wizard

- ▶ Select **Setup** or **Learn more**

#### Exiting the connection wizard

- ▶ Tap the icon in the top right corner of the screen

## VIA LEICA FOTOS CABLE (for iPhone only)



- ▶ Select **iOS**
  - The following screen appears.

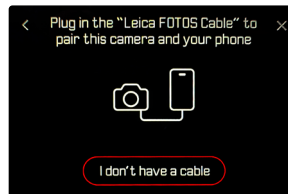

- ▶ Connect the camera and mobile device via the Leica FOTOS cable
- ▶ Follow the instructions provided by the Leica FOTOS app



## WITHOUT LEICA FOTOS CABLE

### IN THE CAMERA



- ▶ Select **iOS**
  - The following screen appears.



- ▶ Select **I don't have a cable**
- ▶ Select **Next**
- ▶ Wait until the QR code appears on the LCD panel

## ON THE MOBILE DEVICE

- ▶ Launch the Leica FOTOS app
- ▶ Select “Add Camera”
- ▶ Select the camera model
  - Connection is being established. The process may take a few seconds.
  - Once successfully connected, the Status LED will light briefly, and the camera displays a relevant message.





## USING THE MENU TO

Where the connection wizard was not used or other mobile devices should be connected, the same settings are always accessible via the menu item **Leica FOTOS**.

### IN THE CAMERA

- ▶ Select **Leica FOTOS** in the main menu
- ▶ Select **Pairing**
- ▶ Wait until the QR code appears on the LCD panel

### ON THE MOBILE DEVICE

- ▶ Launch the Leica FOTOS app
- ▶ Select “Add Camera”
- ▶ Select the camera model
  - Connection is being established. The process may take a few seconds.
  - Once successfully connected, the Status LED will light briefly, and the camera displays a relevant message.

### Notes

- The pairing process may take a few minutes to complete.
- Each mobile device only needs to be paired with the camera once. The process adds the device to the list of known devices.
- The Bluetooth function is disabled if the connectivity mode **Off** is selected (see p.300). **Pairing** will not be available, and the relevant menu item will be grayed out.

## CONNECTING WITH PAIRED DEVICES

### VIA LEICA FOTOS CABLE (for iPhone only)

The Leica FOTOS Cable makes connectivity particularly easy and quick.

- ▶ Connect the camera and mobile device via the Leica FOTOS cable
  - The connection is established automatically.

### Note

USB mode must be set to **Apple MFi** or **Select on Connection** to ensure an automatic connection via the Leica FOTOS Cable.

### VIA WI-FI

#### IN THE CAMERA

- ▶ Select **Leica FOTOS** in the main menu
- ▶ Select **Connectivity**
- ▶ Select **Performance Mode** or **Eco Mode**

#### ON THE MOBILE DEVICE

- ▶ Launch the Leica FOTOS app
- ▶ Select the camera model
- ▶ Confirm the prompt
  - The camera connects to the mobile device automatically.



## CONNECTIVITY (Android users)

### FIRST-TIME CONNECTION TO A MOBILE DEVICE

The connection is established via WLAN. A pairing of the camera and the mobile device is required for a first-time connection to a mobile device. A connection is established via the connection wizard at initial setup of the camera or later via the menu.

### CONNECTION WIZARD

The connection wizard appears at initial startup of the camera or after a camera reset. These settings are also available via the menu item **Leica FOTOS**.

The following screen appears after you have selected the language.

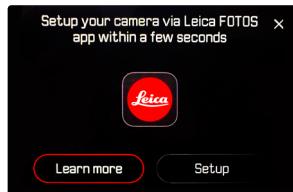

#### Starting the connection wizard

- ▶ Select **Connect to app**

#### Exiting the connection wizard

- ▶ Tap the icon in the top right corner of the screen

#### Going back one step

- ▶ Tap the icon in the top left corner of the screen

### IN THE CAMERA



- ▶ Select **Android**
- ▶ Select **Next**
- ▶ Wait until the QR code appears on the LCD panel

### ON THE MOBILE DEVICE

- ▶ Launch the Leica FOTOS app
- ▶ Select “Add Camera”
- ▶ Select the camera model
  - Connection is being established. The process may take a few seconds.
  - Once successfully connected, the Status LED will light briefly, and the camera displays a relevant message.



## USING THE MENU TO

Where the connection wizard was not used or other mobile devices should be connected, the same settings are always accessible via the menu item **Leica FOTOS**.

### IN THE CAMERA

- ▶ Select **Leica FOTOS** in the main menu
- ▶ Select **Pairing**
- ▶ Wait until the QR code appears on the LCD panel

### ON THE MOBILE DEVICE

- ▶ Launch the Leica FOTOS app
- ▶ Select “Add Camera”
- ▶ Select the camera model
- ▶ Select “Scan the QR code”
- ▶ Scan the QR code
  - Connection is being established. The process may take a few seconds.
  - Once successfully connected, the Status LED will light briefly, and the camera displays a relevant message.

### Notes

- The pairing process may take a few minutes to complete.
- Each mobile device only needs to be paired with the camera once. The process adds the device to the list of known devices.
- The Bluetooth function is disabled if the connectivity mode **Off** is selected (see p.300). **Pairing** will not be available, and the relevant menu item will be **grayed out**.

## CONNECTING WITH PAIRED DEVICES

### IN THE CAMERA

- ▶ Select **Leica FOTOS** in the main menu
- ▶ Select **Connectivity**
- ▶ Select **Performance Mode** or **Eco Mode**

### ON THE MOBILE DEVICE

- ▶ Launch the Leica FOTOS app
- ▶ Select the camera model
- ▶ Confirm the prompt
  - The camera connects to the mobile device automatically.



## CONNECTIVITY MODES

Three connection options are available.

Factory setting: Performance Mode

- ▶ Select Leica FOTOS in the main menu
- ▶ Select Connectivity
- ▶ Select Performance Mode/Eco Mode/Off

	Faster connection (Factory setting)	Extended battery life	All RF connections deactivated
	Performance Mode	Eco Mode	Off
Bluetooth (Geotagging)	On	On	-
Wi-Fi (Data transfer) (Remote control)	The Leica FOTOS connection remains active.	Automatic On / Off The connection to the Leica FOTOS app is established automatically as needed, and disconnected after ≥ 5 min. of inactivity	-
Wi-Fi Sleep Timer	Never	After 5 min	-
Remote Camera Activation	Always available	This function is available up to 7 days after the camera was switched off	-



## PERFORMANCE MODE

Bluetooth is permanently activated, allowing anytime Geotagging (where enabled). Wi-Fi is similarly permanently activated. This option offers the fastest access to Leica FOTOS and therefore an excellent user experience.

- ▶ Select **Leica FOTOS** in the main menu
- ▶ Select **Connectivity**
- ▶ Select **Performance Mode**

## ECO MODE

Bluetooth is permanently activated, allowing anytime Geotagging (where enabled). Camera Wi-Fi will be enabled only during the transfer of settings or files, and will otherwise remain off. This is a power saving option.

- ▶ Select **Leica FOTOS** in the main menu
- ▶ Select **Connectivity**
- ▶ Select **Eco Mode**

## AIRPLANE MODE (Off)

All RF connections will be deactivated if this option is selected

- ▶ Select **Leica FOTOS** in the main menu
- ▶ Select **Connectivity**
- ▶ Select **Off**

## EXECUTING A FIRMWARE UPDATE

Any interruption of a running firmware update may cause serious and irreparable damage to your equipment!

You will therefore have to take particular note of the following, when carrying out a firmware update:

- Do not switch off the camera!
- Do not remove the memory card!
- Do not remove the rechargeable battery!
- Do not detach the lens!

Leica FOTOS will notify you when firmware updates are available for your Leica cameras.

- ▶ Follow the instructions provided by the Leica FOTOS app

### Notes

- A warning message will appear if the battery is insufficiently charged. Recharge the battery and then repeat the process described above.
- Alternatively, firmware updates can also be installed via the camera menu (see p. 289).



## REMOTE CAMERA CONTROL

You can take pictures and record video remotely via the mobile device, and can also change image settings or transfer data to the mobile device. A list of available functions and instructions for their use can be found in the Leica FOTOS app.

### REMOTE CAMERA ACTIVATION

The camera can be activated remotely from off or standby if this function is activated in the camera. The Bluetooth function must be active.

- ▶ Select **Leica FOTOS** in the main menu
- ▶ Select **Connectivity**
- ▶ Select **Performance Mode/Eco Mode**
  - The camera will scan for known devices and automatically establishes a connection.

### Important information

- Remote activation will activate the camera even if it was switched off via the main switch.
- Accidental remote camera activation may result in unwanted pictures taken and excessive power consumption.
- A third-party device can – provided it has been paired with the camera – access the camera remotely if your own mobile device is not currently connected or its Bluetooth function is deactivated. This poses a danger of unauthorized access to your data or camera functions.

### Solution

- Only activate this function just before you want to use it.
- Disable the function as soon as it is no longer needed.



## CARE/STORAGE

We recommend the following if the camera will not be used for an extended period of time:

- Switch off the camera
- Remove the memory card
- Remove the battery (after approx. 2 months the set date and time will be lost)

## CAMERA HOUSING

- Keep your equipment meticulously clean, as any kind of dirt residue presents a breeding ground for micro organisms.
- Only clean the camera with a soft, dry cloth. Stubborn dirt should first be moistened with a watered-down detergent and can then be wiped away with a dry cloth.
- Wet a soft cloth with tap water, wring it out thoroughly and use it to wipe down the camera. Then wipe it down thoroughly with a dry cloth.
- Wipe the camera with a clean, lint-free cloth to remove stains and fingerprints. Tougher dirt in hard to reach corners of the camera housing can be removed with a small brush. Take care not to touch the shutter blades.
- Store the camera in a closed and padded container to prevent friction damage and protect it against dust accumulation.
- Keep the camera in a dry, sufficiently ventilated place, where it will not be subjected to high temperatures and humidity. Make sure to remove all moisture from the camera if it was used in humid conditions.
- Do not store the camera in a leather case for extended periods of time to prevent fungal contamination.

- Empty your camera bag completely if it ever gets wet during use. Your equipment might otherwise be subjected to moisture and tanning residue released by the moist leather.
- All mechanical bearings and sliding surfaces on your camera are lubricated. Remember to press the shutter button several times every three months to prevent the lubrication points hardening if the camera will not be used for an extended period of time. We also recommend repeated adjustment and use of all the other operating elements.
- When using your camera in tropical climates, make sure to expose the equipment to daylight and fresh air as much as possible to prevent fungal growth. Storage in airtight containers or cases is recommended only in conjunction with a desiccant like silica gel.

## LENS

- A soft-bristle brush will usually suffice to remove dust from the outer lenses. Remove more severe soiling with a clean, soft cloth that is completely free of foreign matter. Wipe the lens in a circular motion from the center outward. We recommend using micro-fiber cloths that come in a protective container and are available from photography shops and other optical retailers. These cloths are machine-washable at 40°C. Do not use fabric softener and do not iron them. Never use spectacle lens cleaning cloths, as these are soaked in chemicals, which could damage the glass of the camera lenses.
- Attach a transparent UVA filter for optimal front lens protection in unfavorable conditions (e.g. sand, salt water spray). Please remember that the filter may create unwanted light reflections in some backlight situations and in case of high contrasts.
- Lens caps also protect the lens against accidental fingerprint smudges and rain.



- All mechanical bearings and sliding surfaces on your lens are lubricated. Make sure to periodically move the focus ring and the aperture ring to prevent seizing if the lens will not be used for an extended period of time.

## VIEWFINDER/LCD PANEL

- Switch off your camera and leave it to stand at room temperature for around 1 hour if condensation has formed on or in the camera. The condensation will disappear, once the camera temperature has reached room temperature.

## RECHARGEABLE BATTERY

- Lithium-ion rechargeable batteries should only be stored partially charged, i.e. not fully depleted or fully charged. The camera LCD panel will show the current charge level of the battery. Charge the battery twice a year for around 15 minutes to avoid deep discharge in case of very long storage periods.

## MEMORY CARDS

- Make sure to store memory cards in their anti-static container when not in use.
- Do not store memory cards where they will be exposed to high temperatures, direct sunlight, magnetic fields or static electricity. Always remove the memory card if the camera will not be used for an extended period of time.
- We recommend formatting memory cards from time to time, as fragmented residual data from deleted files may block some of the storage capacity.

## SENSOR

### AUTOMATIC SENSOR CLEANING

Dust residue on sensors can be easily removed. This function causes the sensor to vibrate slightly, which "shakes off" loose dust particles. This function can be accessed and used as needed.

- ▶ Select **Camera Settings** in the main menu
- ▶ Select **Automatic Sensor Cleaning**
- ▶ Select **Yes**
  - Automatic sensor cleaning commences.
  - The camera vibrates for a moment.
  - The message **Please Restart the Camera** appears.
- ▶ Switch the camera off and on again



## PIXEL MAPPING

Defective pixels may appear on the image sensor of digital cameras over time. The camera compensates for these defective pixels automatically by calculating the data captured by other pixels surrounding defective ones. This feature requires a process known as “pixel mapping” to recognize and register defective pixels. The camera does this automatically every two weeks. The function can also be accessed manually if needed.

- ▶ Select **Camera Settings** in the main menu
- ▶ Select **Pixel Mapping**
- ▶ Select **Yes**
  - Pixel mapping is executed. The process may take a few seconds.
  - The message **Please Restart the Camera** appears.
- ▶ Switch the camera off and on again



Problem	Possible causes to check	Troubleshooting suggestions
<b>Battery issues</b>		
Battery is depleted too quickly	Battery too cold	Warm the battery (e.g. in pants pocket) and only insert directly before use
	Battery too hot	Allow battery to cool down
	LCD panel or EVF set too bright	Reduce brightness
	Power save mode deactivated	Activate <a href="#">Auto Power Off</a>
	AF mode permanently activated	Select other mode
	Permanent WLAN connection	Deactivate WLAN when not in use
	Continuous use of LCD panel (e.g. in Live View mode)	Deactivate the function
	Battery has been recharged too many times	The battery has reached the end of its operating time Replace battery
	Tracking-AF with AFc activated	Use AFs or MF
Preview of the recorded images ( <a href="#">Auto Review</a> ) activated	Deactivate the function	
Charging process not starting	Incorrect battery polarization or faulty charger connection	Check polarization and connection
Charging takes too long	Battery too hot or too cold	Charge the battery at room temperature
Charging pilot light is on, but battery isn't charging	The battery contacts are dirty	Clean the contacts with a soft, dry cloth
	Battery has been recharged too many times	The battery has reached the end of its operating time Replace battery
<b>Camera problems</b>		
The camera suddenly switches itself off	Battery is depleted	Charge or replace the battery
The camera won't switch on	Battery is depleted	Charge or replace the battery
	Battery too cold	Warming the battery (e.g. in pants pocket)
The camera switches off again immediately after it is switched on	Battery is depleted	Charge or replace the battery
Camera is heating up	Heat development due to high-res video recording (4K) or serial exposures with DNG	Not a fault; allow camera to cool down if it gets too hot
Camera does not recognize the memory card	The memory card is not compatible or defective	Replace the memory card
	Memory card is incorrectly formatted	Format the memory card in the camera (Caution: Loss of data!)

<b>Menus and displays</b>		
Electronic viewfinder is dark	EVF brightness is set too low	Set the EVF brightness
Display language is not English	-	Select <b>English</b> in the <b>Language</b> menu
Electronic viewfinder is dark	Switchover between EVF and LCD incorrectly set	Select a suitable setting
Viewfinder is out of focus		Check the diopter setting and adjust as needed
The LCD panel is too dark or too bright/not clear	The brightness setting is incorrect	Adjust the display brightness
	Viewing angle is too small	View the LCD panel at a perpendicular angle
	Brightness sensor is blocked	Make sure that the brightness sensor is not blocked
<b>Favorites</b> menu does not appear	The favorites menu is empty	Add at least one function
Live View stops suddenly or doesn't start	The camera is hot due to high ambient temperature, extended Live View operation, extended video shooting or continuous shooting	Allow camera to cool down
The brightness in Live View mode is not the same as in the images	The brightness settings for the LCD panel have no influence over the exposures	Adjust the brightness settings as needed
	Exposure preview is deactivated	Activate the function
The number of remaining shots does not count down after shooting	The image requires only very little memory space	This is not a fault; the number of remaining shots is calculated as approximations
<b>Shooting</b>		
Image noise appears on the LCD panel/in the viewfinder when the shutter button is pressed to the first pressure point	The gain is increased to aid image composition if the object is insufficiently lit with reduced lens aperture	Not a fault - image quality will not be impacted
LCD panel/viewfinder deactivates after a very short time	Power Save settings are activated	Change the settings as needed
The display switches off after shooting/the LCD panel goes dark after shooting	Flash loads after shooting, LCD panel deactivates during load time	Wait until the flash is charged
Flash won't fire	The flash cannot be used with the current settings	Refer to the list of flash function-compatible settings
	Battery is depleted	Charge or replace the battery
	Pressing the shutter button while flash is still loading	Wait until the flash is loaded
	Electronic shutter function is selected	Change the setting
The flash does not fully illuminate the object	Automatic bracketing or continuous shooting is activated	Change the setting
	Object is outside the flash range	Move object into flash range
	Flash is covered	Make sure the flash unit is not covered by your finger or some object

The camera won't release/shutter button is deactivated/shooting not possible	Memory card is full	Replace the memory card
	The memory card is not formatted	Reformat the memory card (Caution: Loss of data!)
	The memory card is write protected	Deactivate the write protection on the memory card (small lever on the side of the memory card)
	Dirt on the memory card contacts	Clean the contacts with a soft cotton or linen cloth
	The memory card is damaged	Replace the memory card
	The sensor is overheating	Allow camera to cool down
	The camera has switched off automatically (Auto Power Off)	Switch the camera on again deactivate auto shutdown as needed
	Image data is being written to the memory card and the cache is full	Wait
	Noise reduction function is working (e.g. after night photography with long exposure times)	Wait or deactivate noise reduction
	Battery is depleted	Charge or replace the battery
	Camera is processing a image	Wait
Image numbering has reached its limit	See section "Data Management"	
Image does not sharpen automatically	AF is deactivated	Activate AF
No face detection/faces are not recognized	Face is covered (sunglasses, hat, long hair, etc.)	Remove distracting objects
	Face takes up to little space in the picture composition	Change image composition
	Face is tilted or horizontal	Keep face straight
	Camera not held straight	Hold camera straight
	Face is insufficiently lit	Use flash, improve illumination
Camera selects incorrect object	The incorrectly selected object is closer to the image center than the main object	Change the image section or take picture using the focus lock
	The incorrectly selected object is a face	Deactivate face detection
No continuous shooting available	The camera is overheated and the function was temporarily disabled to protect the camera	Allow camera to cool down
The image on the LCD panel displays lots of noise	Light enhancement function of the LCD panel in dark surroundings	Not a fault - image quality will not be impacted
Image storage takes a long time	Noise reduction is activated for long-term exposures	Deactivate the function
	The memory card inserted is slow	Use a suitable memory card
Manual white balance is unavailable	The image object is too bright or too dark	

Camera does not focus	Desired object part is too close to the camera	Select Macro mode
	Desired object part is very far away	Exit Macro mode
	Object not suitable for AF	Use Focus lock or select manual focus
AF frame is framed in red with activated AF; images out of focus	Focusing was unsuccessful	Try to focus again
No AF frame selectable	Focus ring not in AF position	Turn the focus ring to the AF position
	Automatic Metering Field Control or Face Detection in AF Mode is selected	Select other control mode
	Image review is activated	Deactivate image review
	Camera is in Standby mode	Press the shutter button to the first pressure point
AF assist lamp does not light up	Camera is in video shooting mode	Change the mode
	Function is deactivated	Activate AF
<b>Video recording</b>		
No video is recorded	The camera is overheated and the function was temporarily disabled to protect the camera	Allow camera to cool down
Video shooting stops	Maximum length of individual video sequence was reached	
	The memory card's write speed is too low for the selected video resolution/compression	Insert another memory card or change the storage method
L-Log is not selectable in video mode	A 10 bit format was not selected as the video format	Switch to 10bit format or MOV in video format
In video mode, I see ASA instead of ISO, angle instead shutter speed and T-aperture values instead of F-values	Cine was selected as shooting mode	Switch from Cine to Video mode
There are visible exposure jumps during zooming	The camera is set to Auto ISO	Activate Floating ISO
<b>Review and photo management</b>		
Selected images cannot be deleted	Some of the selected images are write protected	Remove write protection (using the device with which the file was originally set to write protected)
File numbering does not start at 1	The memory card contains previously stored images	See section "Data Management"
The time and date settings are incorrect or are not displayed	The camera has not been in use for an extended period of time (the battery was removed)	Insert a charged battery and configure the correct settings
The time and date stamp on images are incorrect	Time settings are incorrect	Set the time correctly Caution: Time settings will be lost if the camera is not used/remains in storage with a depleted battery over an extended period of time

The time and date stamp on images are unwanted	Setting was ignored	Cannot be removed in retrospect Deactivate the function as needed
Images are damaged or missing	The memory card was removed while the readiness indicator was flashing	Never remove the memory card while the readiness indicator is flashing. Charge the battery.
	The memory card formatting is faulty or the card is damaged	Reformat the memory card (Caution: Loss of data!)
The most recent image is not displayed on the LCD panel	Preview is deactivated	Activate <b>Auto Review</b>
Parts of my video scenes are not fully in the picture	Difference of aspect ratios between camera and playback medium	Set the correct aspect ratio on the camera
<b>Image quality</b>		
The image is too bright	Light sensor was covered during shooting	Make sure that the light sensor is not obstructed
Image noise	Long exposure times (> 1 s)	Activate the noise reduction function for long-term exposure
	ISO sensitivity set too high	Decrease ISO sensitivity
Unnatural colors	White balance not or incorrectly set	Adjust white balance to light source or adjust manually
Round white stains, similar to soap bubbles	Flash photography in a very dark environment: reflections of dust particles	Deactivate the flash
Images are out of focus	Lens is dirty	Clean the lens
	Lens is obstructed	Make sure that lens is unobstructed
	Camera moved during shooting	Use flash
		Mount the camera on a tripod
Macro Function	Use faster shutter speeds	
Images are overexposed	Flash is activated in bright surroundings	Change the flash mode
	Strong light source in the image	Avoid strong light sources in the image
	(Half) backlight falling into the lens (also from light sources outside the image range)	Use the lens hood or change to another object
	Selected exposure time is too long	Select a shorter exposure time
Out of focus/picture stabilizer not functioning	Shooting at a dark location without flash	Use a tripod
The image is grainy or there is image noise	ISO sensitivity set too high	Decrease ISO sensitivity
Horizontal stripes	Picture was taken with electronic shutter under a light source like a fluorescent lamp	Try shorter shutter speeds



Unnatural colors and brightness	Shooting in artificial light or extreme brightness	Set white balance or select correct lighting presets
No images are displayed	No memory card inserted	Insert a memory card
	The photos were taken with another camera	Transfer the files to another device to view them
Images cannot be displayed	File name was changed on a PC	Use suitable software for file transfers from a PC to the camera
<b>Video quality</b>		
Video recordings show flickering/stripes	Light source interference in artificial lighting	Select a different frame rate (suitable for the local alternating current (AC) grid frequency) under <b>Video Profiles</b>
Camera noise in video recording	The dials were used	Avoid using the dials during video shootings
No sound on video recording	Playback volume is set too low	Increase playback volume
	Microphone was covered during shooting	Make sure the microphone is not obstructed while shooting video
	Speakers are covered	Make sure that speakers are unobstructed during playback
	Microphone was deactivated while recording	Activate the microphone
Flickering or horizontal stripes in the video recording	CMOS sensors will display this phenomenon when light sources like LED lamps or fluorescent tubes are used	Quality may be improved by selecting a manual shutter speed (e.g. 1/100s)
<b>Smartphones/WLAN</b>		
WLAN connection gets interrupted	Camera deactivates when it overheats (safety feature)	Allow camera to cool down
Cannot pair with a mobile device	The camera was already paired with the mobile device	Delete the camera registration from the Bluetooth settings in the mobile device and repeat pairing process
Mobile device connection/image transfer not working	The mobile device is too far away	Bring the devices closer to each other
	Interference from other devices in the vicinity, e.g. other smartphones or a microwave oven	Increase distance to interfering devices
	Interference from multiple mobile devices in the vicinity	Re-establish the connection/disconnect other mobile devices
	Mobile device is currently connected to another device	Check connection
Camera does not appear on the WLAN configuration screen of the mobile device	Mobile device does not recognize camera	Switch the WLAN function of the mobile device off and on again

### FUNCTION BUTTONS

The following control elements are available for direct access (see p. 76).

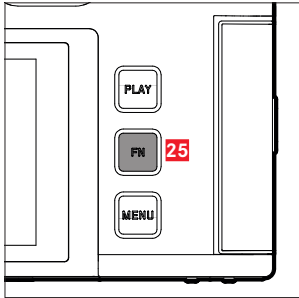

- 25** FN button
- 20** Function button

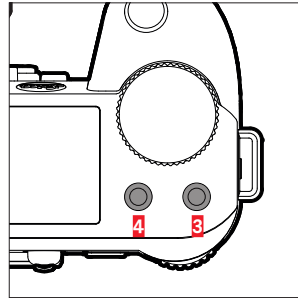
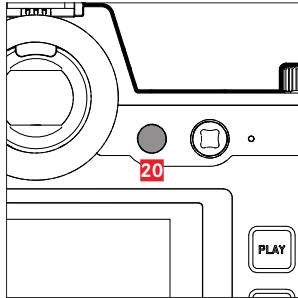

- 3** Function button
- 4** Function button
- 9** Function button
- 10** Function button

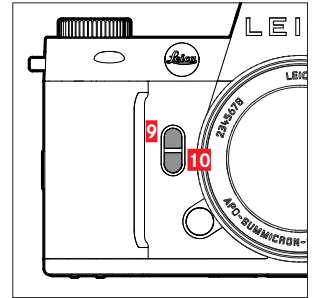

### LEGEND

- ◆ = Accessible via the Control Center
- = Available for function buttons
- = Factory setting on the function buttons

## DIRECT ACCESS



Function	PHOTO		VIDEO/CINE		
	Control Center	Function buttons	Control Center	Function buttons	
Photo <> Video	◆	● ● (4)	◆	● ● (4)	
Toggle Info Levels		● ● (25)		● ● (25)	
Magnification		● ● (9)		●	
Toggle AF/MF		●		●	
Toggle Focus Point		●			
Exposure/DOF Simulation		●			
Toggle Video Gamma				●	
Audio Levels (Microphone Gain + headphone volume)			◆	● ● (9)	
Exposure Mode	◆		◆		
Focus Mode	◆	●	◆	●	
AF Mode	◆	● ● (10)	◆	● ● (10)	
Focus Settings					
AF Setup		●		●	
AF Profiles		●			



Function	PHOTO		VIDEO/CINE	
	Control Center	Function buttons	Control Center	Function buttons
Focus Aid		●		
AF Assist Lamp		●		
Auto Magnification		●		●
Touch AF		●		●
Touch AF in EVF		●		●
Focus Limit (Macro)		●		●
Manual Focus Throw		●		●
Exposure Metering	◆	●	◆	●
ISO Settings	◆	●	◆	●
Auto ISO Settings		●		● (in video mode only)
Floating ISO		●		●
ISO Increment		●		●
EV Increment		●		●
Drive Mode	◆	●		
Interval Shooting		●		
Exposure Bracketing		●		
Self-timer		●		

Function	PHOTO		VIDEO/CINE	
	Control Center	Function buttons	Control Center	Function buttons
White Balance	◆	● ● 3	◆	●
Gray card		●		●
Color Temperature		●		●
File Format	◆	●		
DNG Resolution		●		
JPG Settings				
JPG Resolution		●		
Noise Reduction (JPG)				
Leica Looks		●		
iDR		●		●
Film Style		●		
Noise Reduction (long exposure)		●		
Perspective Control		●		
Sensor Format		●		
Stabilization		●		
Image Stabilization		●		●
Panning Mode				
Aspect Ratio		●		
Flash Settings		●		



Function	PHOTO		VIDEO/CINE	
	Control Center	Function buttons	Control Center	Function buttons
Flash Mode				
Flash Exp. Compensation		●		
Flash Sync				
Customize Control				
Dials (AF lenses)		●		●
Dials (MF lenses)		●		●
Dial Lock		●		●
Joystick Lock		●		●
Capture Assistants		●		●
Image Overlay		●		
Focus Peaking		●		●
Clipping / Zebra		●		●
Framelines				●
Waveform Monitor				●
Storage Management				
Format Storage		●		●
Storage Options		●		
Shutter Type		●		
Auto Review		●		
Group Display Mode		●		

Function	PHOTO		VIDEO/CINE	
	Control Center	Function buttons	Control Center	Function buttons
Live View Settings				
Exposure Preview		●		
Enhanced Live View		●		
Leica FOTOS	◆	●	◆	●
USB Charging		●		●
USB Mode				
Wi-Fi				
User Profile		●		●
Camera Settings				
Display Settings				
EVF <> LCD		●		●
			20	20
Power Saving				
Lens Profiles		●		●
Distance Unit				
Acoustic Signal		●		●
Date & Time				
Reset Image Numbering				
Automatic Sensor Cleaning				
Pixel Mapping				

Function	PHOTO			VIDEO/CINE		
	Control Center	Function buttons		Control Center	Function buttons	
Reset Camera						
Camera Information						
Language						
Exposure Compensation	◆	●		◆	●	
ISO (Photo & Video)*	◆	●	●	◆	●	●
Exposure Index (Cine)*			3			3
Video Profiles				◆	●	
Log Settings					●	
HLG Settings						
L-Log Settings						
LUT Profile					●	
Leica Looks					●	
Video Style					●	
Cine Mode					●	
HDMI with Audio						
Audio						
Microphone Gain					●	
Wind Noise Reduction					●	
Timecode					●	
Segmented Video					●	



Function	PHOTO		VIDEO/CINE	
	Control Center	Function buttons	Control Center	Function buttons
Color Bar				•
REC Frame				•

\* Some function are available only via direct access. These are listed at the top of the table.



## DIRECT ACCESS IN REVIEW MODE

Function	Review (photo)/Playback (video)	
	Play Menu	Function buttons
Toggle Info Levels		● (25)
Rate / Unrate		● (3)
EVF <> LCD		● (20)
Magnification (photos only)		● (10)
Delete Single	●	● (4)
Delete Multi	●	● (9)
Delete All without ★	●	●



## A

A (aperture-priority mode).....	150, 268
Academy, Leica .....	339
Accessories.....	3
Acoustic signals .....	88
Adapter .....	43
AE-L .....	155, 156
AF assist lamp .....	121, 132, 233
AFc.....	123, 238
AF confirmation.....	88, 121
AF-L .....	156
AF/MF, toggling.....	123
AF mode.....	123, 238
AF Mode.....	124, 239
AF Quick Setting .....	130
AFs.....	123, 238
Airplane mode .....	299
Aperture.....	147, 266
Aperture-priority mode .....	150, 268
App .....	292
Apple MFi.....	108, 214
ASA .....	260
Aspect ratio (video) .....	229
Assist function .....	113, 220, 230
Assist functions, AF.....	121, 131, 233, 245
Assist functions, MF.....	134, 247
Autofocus.....	123, 127, 238

Auto ISO.....	138, 257
Automatic review.....	184, 193
Auxiliary displays.....	113, 220

## B

Basic image settings (photo).....	90
Basic recording settings (video).....	194
Basic settings, camera .....	82
Basic settings, recording (video).....	194
Basic settings, shooting (photo) .....	90
Bluetooth.....	298
Brightness, EVF .....	86
Brightness, LCD panel .....	86
Bulb.....	153
Button assignment .....	74

## C

Calibration.....	230
Camera information.....	287
Camera, reset.....	286
Care .....	302
Carry strap.....	10, 34
Center-weighted metering.....	146, 265
Charger.....	9, 34
Charge status, charger .....	35
Charge status, LCD panel.....	33
Charging the battery.....	35
Cine.....	234
Clipping.....	116, 183, 223, 275
Color bar .....	230

Color Bar .....	230	Depth of field.....	159
Color profile .....	96	Depth-of-field preview button.....	159
Color rendering, EVF .....	86	Dial, front .....	55, 75
Color rendering, LCD panel .....	86	Diopter compensation .....	45
Color saturation, image properties (photo) .....	95	Direct access .....	74, 313
Color saturation, image properties (video).....	196	Displays.....	28, 30, 32, 113, 220
Color settings, EVF.....	86	Display, settings .....	84
Color settings, LCD panel.....	86	Display, standby .....	87
Color temperature .....	143, 263	Disposal .....	6
Connection, mobile devices .....	292	Distance display .....	136, 249
Connectivity .....	298	Distance unit.....	83
Contact, Leica .....	338	DNG .....	91
Continuous shooting .....	160	DNG Resolution .....	92
Contrast, image properties (photo).....	95	DOF (Depth of Field).....	159
Contrast, image properties (video) .....	196	Drive Mode.....	122, 160, 161
Control Center .....	28, 30, 64	Dynamic ISO setting.....	140, 259
Copyright .....	106, 212	Dynamic Range .....	101, 207
Customer Service.....	338		
Custom LUT profiles .....	203		
		<b>E</b>	
<b>D</b>		Editing, video.....	284
Dark area optimization .....	101, 207	Electronic shutter .....	88, 145
Data management .....	102, 209	Electronic shutter sound .....	88
Data structure .....	104, 210	Enhanced Live View.....	120
Data transfer .....	108, 214	EVF .....	87
Date .....	71, 82	EV Increment.....	112, 218
Deactivation, LCD panel .....	87	Exposure .....	144, 264
Deletion, photos.....	189, 278	Exposure, automatic.....	149, 267
Deletion, user profiles .....	79	Exposure bracketing.....	163
		Exposure compensation .....	158, 269

Exposure compensation, flash.....	176	Flash, firing point.....	174
Exposure lock.....	155	Flash, operating mode.....	173
Exposure, long-term.....	98, 152	Flash, range.....	175
Exposure, manual.....	151, 268	Flash, setting.....	173
Exposure metering, flash.....	172	Flash, synchronization.....	174
Exposure, metering methods.....	146, 264	Flash units, compatible.....	171
Exposure, modes.....	147, 266	Floating ISO.....	140, 259
Exposure preview.....	155	FN button.....	58, 313
Exposure simulation.....	155	Focus assist.....	134, 247
Exposure time, max.....	152	Focusing.....	123, 237
Eye sensor.....	85	Focusing, automatic.....	123, 238
<b>F</b>			
Face detection.....	126, 241	Focusing, manual.....	133, 246
Factory settings.....	286	Focusing, metering methods.....	124, 239
FAQ.....	306	Focus limit.....	130, 243
Favorites, menu.....	313	Focus mode.....	123, 237
Favorites, shots (photo).....	189, 277	Focus peaking.....	117, 134, 224, 247
Field metering.....	124, 239	Folder, creating new.....	106, 212
File format.....	91, 194	Folders.....	104, 210
File name.....	105, 108, 211, 214	Folder structure.....	104, 210
Files, RAW.....	91	Follow Focus.....	249
Film Style.....	95	Format.....	91, 194
Firing point, flash.....	174	Formatting, memory card.....	103, 209
Firmware.....	14, 287	<b>G</b>	
Fixed ISO value.....	137, 256	General information.....	12
Flash.....	171	Gimbal.....	237
Flash, control.....	174	Gray card.....	142, 262
Flash, exposure compensation.....	176	Grid.....	116, 223
Flash, exposure metering.....	172		

<b>H</b>	
Handgrip .....	46
HDMI .....	219
HDR .....	163
Highlight, image properties (photo).....	95
Highlight, image properties (video) .....	196
Highlight-Weighted, exposure .....	147, 265
Histogram.....	119, 226
Horizon.....	118, 225
<b>I</b>	
iDR .....	101, 208
Image numbering.....	104, 210
Image numbering, reset.....	106, 212
Image Overlay .....	169
Image properties .....	94
Image, series.....	160, 161, 163
Image stabilization (picture).....	99
Image stabilization, video .....	207
Increment, EV.....	112, 218
Individual button assignment.....	74
Info Bars.....	115, 222
Info profiles .....	113, 220
Information displays .....	113, 220
Information, legal .....	4
Information, regulatory.....	5
Inserting/removing the battery .....	36
Intelligent AF .....	123, 238
Intelligent Dynamic Range .....	101, 207
Interval shooting.....	161
ISO Sensitivity.....	137, 256
ISO setting, dynamic .....	140, 259
ISO value, greatest .....	139, 258
<b>J</b>	
Joystick .....	56, 78
JPG.....	91
<b>K</b>	
Keyboard.....	69
Keylock .....	78
<b>L</b>	
Language.....	82
LCD panel.....	84
Left dial .....	55, 75
Legal information.....	4
Leica Akademie .....	339
Leica Customer Care.....	338
Leica FOTOS.....	7, 292
Leica Looks .....	97
Lens .....	9, 40, 290, 302
Level gauge .....	118, 225
Lock .....	78
Long-term exposure .....	98, 152
LUT.....	203
<b>M</b>	
Magnification, MF assist function.....	134
Magnification, recording mode (video).....	245, 247

Magnification, review mode (photo).....	186
Magnification, shooting mode (photo) .....	131, 134, 245
Magnifying glass.....	134
Main menu .....	66
Main switch.....	52
Manual exposure setting .....	151, 268
Manual focusing.....	133, 246
Maximum Exposure Time .....	152
Memory card.....	10, 13, 38, 102, 103, 209, 303
Menu bar.....	70
Menu control.....	60
Menu language.....	82
Menu navigation.....	63, 67
Menu screen .....	61
Metering method, AF.....	124, 239
Metering method, exposure.....	146, 264
MF.....	133, 246
Microphone.....	198
M (Manual exposure setting) .....	151, 268
Mode, switching.....	235
Monochrome (picture).....	96
Monochrome recording, video.....	197
Monochrome shooting (photo) .....	96
Monochrome (video) .....	197
MOV.....	194
MP4.....	194
Multi-field metering, exposure.....	146, 265
Multi-field metering, focusing.....	124, 239

**N**

Name, file.....	104, 105, 108, 210, 211, 214
Name, folder .....	104, 210
Navigation, menu.....	63, 67
Noiseless.....	88
Noise reduction.....	98, 99, 150, 152
Number pad .....	69

**O**

Offline mode.....	299
One-Minute videos.....	209
Operating mode, exposure .....	147, 266
Operating mode, flash .....	173
Operation, customized .....	74
Optical image stabilization.....	99
Overlay.....	169
Overview, parts .....	24

**P**

Part Designations.....	24
Person detection.....	126, 241
Perspective Control.....	166
Photo Aspect Ratio.....	94
Photos, delete .....	189, 278
Photos, rating.....	189, 277
Photos, tagging .....	189, 277
Pixel Mapping.....	304
Playback mode.....	270
Playback, video .....	281
PLAY button .....	57





Short cut .....	74	Timecode .....	200
Shutter button .....	54	Time lapse .....	161, 185
Shutter, electronic .....	88, 145	Time zone .....	83
Shutter-priority mode .....	151, 268	Tones .....	88
Shutter release .....	54	Touch AF .....	110, 216
Shutter speed .....	147	Touch control .....	59, 110, 216
Shutter-speed/aperture combination .....	147, 266	Tracking .....	125, 240
Signals, acoustic .....	88	Transfer, data .....	108, 214
Silent .....	88	Troubleshooting .....	306
Silent operation .....	88	TTL metering .....	171, 172
Smartphone .....	292		
Sound .....	88, 283	<b>U</b>	
Spot metering, exposure .....	146, 265	Update, firmware .....	14, 287
Spot metering, focusing .....	124, 239	USB .....	36
S (Shutter-priority mode) .....	151, 268	USB mode .....	108, 214
Standby mode .....	84	User-defined operation .....	74
Storage .....	302	User profiles .....	79
Submenu .....	66		
Switching, mode .....	180, 235, 272	<b>V</b>	
Switching on, camera .....	52	Video .....	234, 281
Sync point .....	174	Video format .....	195
		Video Gamma .....	202
<b>T</b>		Video mode .....	234
Tagging, shots (photo) .....	189, 277	Video stabilization .....	207
Tally .....	232	Video Style .....	196
Technical Data .....	330	Volume, acoustic signals .....	88
Test image .....	230	Volume, video .....	283
Tethering .....	108, 214		
Thumbwheel .....	56, 75	<b>W</b>	
Time .....	71, 82	Warning signal .....	88

Waveform Monitor .....	227
White balance.....	141, 261
Wi-Fi/WLAN.....	7, 298
Wind noise reduction.....	199

**Z**

Zebra.....	223
Zone, focusing.....	125, 240

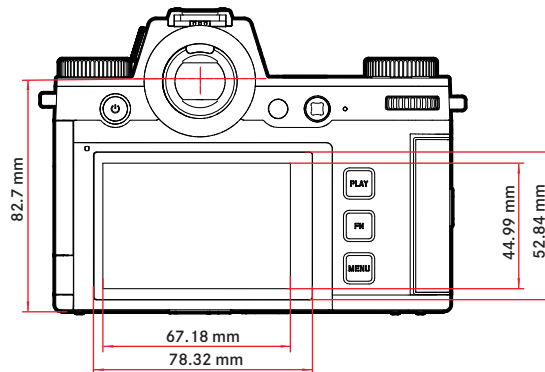
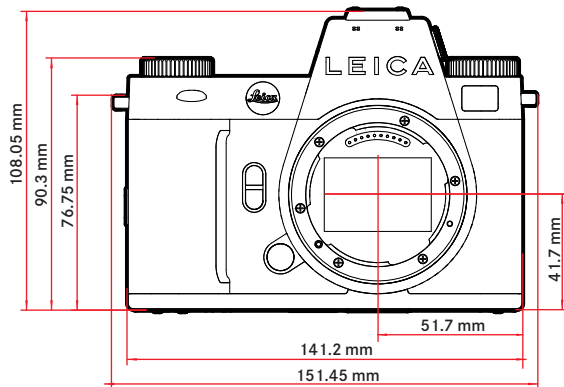
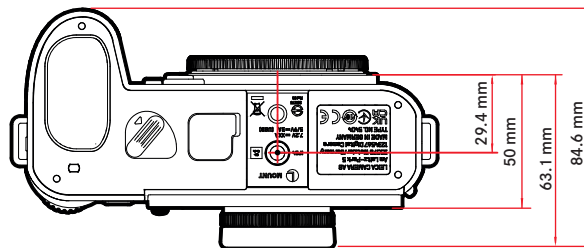
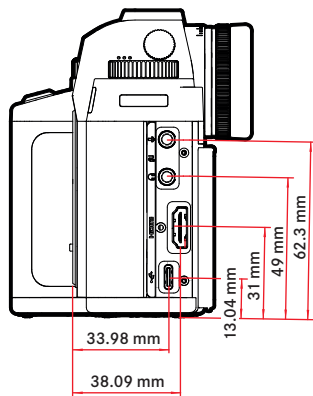

**CAMERA****Designation**

Leica SL3

**Camera type**

Mirrorless full-frame system camera

**Type No.**

5404

**Order No.**

10 607 EU/US/CN, 10 608 JP, 10 609 ROW

**Buffer memory**

8 GB

Capacity, depending on frame rate and picture format, estimated quantity (number of possible images in the buffer memory)

Continuous shooting	DNG	DNG + JPG	JPG
15 fps, 12 bit	60fps	60fps	60fps
9 fps, 12 bit	75fps	65fps	75fps
7 fps, 12 bit	80fps	70fps	80fps
6 fps, 14 bit	90fps	75fps	90fps
5 fps, 12 bit, AF	90fps	75fps	90fps
4 fps, 14 bit, AF	100fps	80fps	105fps
2 fps, 14 bit, AF	400fps	120fps	unlimited

The values depend on the type of memory card used (SD or CFexpress) / resolution

**Storage medium**

UHS-II (recommended), UHS-I, SD/SDHC/SDXC card + CFexpress card type B (recommended)

**Material**

Full metal housing: magnesium and aluminum, leatherette covering, splash water protected in accordance with IEC Standard 60529 (protection type IP54)

**Lens mount**

Leica L bayonet with contact strip for communication between lens and camera

**Operating conditions**

-10 to +40°C

**Interfaces**

- ISO accessory shoe with additional control contacts
- Timecode Interface
- HDMI jack 2.1 Type A
- USB 3.1 Gen1 Type-C
- Audio output 3.5 mm/Audio input 3.5 mm
- Communication interface in the bottom cover of the multifunction handgrip

**Tripod thread**

A 1/4 DIN 4503 (1/4") with stainless steel in the base

**Weight**

Approx. 769.7 g (without battery, SD card, body cap)

**SENSOR****Sensor size**

CMOS sensor, 62.39 MP/60.3 MP (total/effective)

**Processor**

Leica Maestro series (Maestro IV)

**Image stabilization**

5-axis image stabilization up to 5-stops

**Filter**

RGB color filter, UV/IR filter, no low-pass filter



## File formats

Photo: DNG™ (raw data), DNG + JPG, JPG (DCF 2.0, Exif 2.31)

Video:

MP4	h.265	AAC	48 kHz/16 bit
	h.264	AAC	48 kHz/16 bit
MOV	h.265	LPCM	48 kHz/24 bit
	h.264	LPCM	48 kHz/24 bit
	ProRes	LPCM	48 kHz/24 bit

## Image resolution

35 mm	JPG		DNG	
<b>L</b>	9520x6336	60.3 MP	9520x6336	60.3 MP
<b>M</b>	7392x4928	36.4 MP	7404x4928	36.5 MP
<b>S</b>	5280x3504	18.5 MP	5288x3518	18.6 MP
APS-C	JPG		DNG	
<b>L</b>	6256x4160	26.0 MP	6256x4168	26.1 MP
<b>M</b>	4864x3232	15.7 MP	4868x3242	15.8 MP
<b>S</b>	3472x2304	8.0 MP	3476x2314	8.0 MP

## File size

DNG™: approx. 70 MB, depending on resolution and image content

JPG: depending on resolution and image content

Video: max. length depending on ambient temperature and available memory space

## Color depth

DNG™: 14 bit (12 bit possible depending on continuous shooting mode selected)

JPG: 8 bit

## Color space

Photo: sRGB

Video: Rec. 709/Rec. 2020 (HLG/L-Log)

## Shooting Mode Video

Video mode: P - A - S - M

Cine mode: M

## Video Resolution

	RESOLUTION
C8K (17:9)	8192x4320
8K (16:9)	7680x4320
C4K (17:9)	4096x2160
4K (16:9)	3840x2160
Full HD (16:9)	1920x1080

## Video frame rate / bit rate

MOV C8K				
MOV C8K (recording to SD)				
29.97fps	C8K 4:2:0 / 10bit	h.265	L-GOP	300Mbps
25.00fps	C8K 4:2:0 / 10bit	h.265	L-GOP	300Mbps
24.00fps	C8K 4:2:0 / 10bit	h.265	L-GOP	300Mbps
23.98fps	C8K 4:2:0 / 10bit	h.265	L-GOP	300Mbps
MOV C8K (HDMI output without HLG/L-Log and without recording to SD)				
29.97fps	8K 4:2:0 / 8bit	h.265	L-GOP	300Mbps
25.00fps	8K 4:2:0 / 8bit	h.265	L-GOP	300Mbps
24.00fps	8K 4:2:0 / 8bit	h.265	L-GOP	300Mbps
23.98fps	8K 4:2:0 / 8bit	h.265	L-GOP	300Mbps
MOV C8K (HDMI output with HLG/L-Log or during recording to SD)				
29.97fps	C4K 4:2:2 / 10bit	h.265	L-GOP	300Mbps
25.00fps	C4K 4:2:2 / 10bit	h.265	L-GOP	300Mbps
24.00fps	C4K 4:2:2 / 10bit	h.265	L-GOP	300Mbps
23.98fps	C4K 4:2:2 / 10bit	h.265	L-GOP	300Mbps
MOV 8K				
MOV 8K (recording to SD)				
29.97fps	8K 4:2:0 / 10bit	h.265	L-GOP	300Mbps
25.00fps	8K 4:2:0 / 10bit	h.265	L-GOP	300Mbps
24.00fps	8K 4:2:0 / 10bit	h.265	L-GOP	300Mbps
23.98fps	8K 4:2:0 / 10bit	h.265	L-GOP	300Mbps
MOV 8K (HDMI output without HLG/L-Log and without recording to SD)				
29.97fps	8K 4:2:0 / 8bit	h.265	L-GOP	300Mbps
25.00fps	8K 4:2:0 / 8bit	h.265	L-GOP	300Mbps
24.00fps	8K 4:2:0 / 8bit	h.265	L-GOP	300Mbps
23.98fps	8K 4:2:0 / 8bit	h.265	L-GOP	300Mbps
MOV 8K (HDMI output with HLG/L-Log or during recording to SD)				
29.97fps	4K 4:2:2 / 10bit	h.265	L-GOP	300Mbps
25.00fps	4K 4:2:2 / 10bit	h.265	L-GOP	300Mbps
24.00fps	4K 4:2:2 / 10bit	h.265	L-GOP	300Mbps
23.98fps	4K 4:2:2 / 10bit	h.265	L-GOP	300Mbps

MOV C4K				
59.94 fps	4:2:2 / 10 bit (SD & HDMI)	h.264	ALL-I	600 Mbps
50.00 fps	4:2:2 / 10 bit (SD & HDMI)	h.264	ALL-I	600 Mbps
48.00 fps	4:2:2 / 10 bit (SD)	h.264	ALL-I	600 Mbps
24.00 fps	4:2:2 / 10 bit (HDMI)			
47.95 fps	4:2:2 / 10 bit (SD)	h.264	ALL-I	600 Mbps
23.98 fps	4:2:2 / 10 bit (HDMI)			
29.97 fps	4:2:2 / 10 bit (SD & HDMI)	h.264	ALL-I	400 Mbps
25.00 fps	4:2:2 / 10 bit (SD & HDMI)	h.264	ALL-I	400 Mbps
24.00 fps	4:2:2 / 10 bit (SD & HDMI)	h.264	ALL-I	400 Mbps
23.98 fps	4:2:2 / 10 bit (SD & HDMI)	h.264	ALL-I	400 Mbps
MOV 4K				
59.94 fps	4:2:2 / 10 bit (SD & HDMI)	h.264	ALL-I	600 Mbps
50.00 fps	4:2:2 / 10 bit (SD & HDMI)	h.264	ALL-I	600 Mbps
48.00 fps	4:2:2 / 10 bit (SD)	h.264	ALL-I	600 Mbps
24.00 fps	4:2:2 / 10 bit (HDMI)			
47.95 fps	4:2:2 / 10 bit (SD)	h.264	ALL-I	600 Mbps
23.98 fps	4:2:2 / 10 bit (HDMI)			
29.97 fps	4:2:2 / 10 bit (SD & HDMI)	h.264	ALL-I	400 Mbps
25.00 fps	4:2:2 / 10 bit (SD & HDMI)	h.264	ALL-I	400 Mbps
24.00 fps	4:2:2 / 10 bit (SD & HDMI)	h.264	ALL-I	400 Mbps
23.98 fps	4:2:2 / 10 bit (SD & HDMI)	h.264	ALL-I	400 Mbps
MOV FHD				
119.88 fps	4:2:2 / 10 bit (SD & HDMI)	h.264	ALL-I	400 Mbps
100.00 fps	4:2:2 / 10 bit (SD & HDMI)	h.264	ALL-I	400 Mbps
59.94 fps	4:2:2 / 10 bit (SD & HDMI)	h.264	ALL-I	200 Mbps
50.00 fps	4:2:2 / 10 bit (SD & HDMI)	h.264	ALL-I	200 Mbps
48.00 fps	4:2:2 / 10 bit (SD)	h.264	ALL-I	200 Mbps
24.00 fps	4:2:2 / 10 bit (HDMI)			
47.95 fps	4:2:2 / 10 bit (SD)	h.264	ALL-I	200 Mbps
23.98 fps	4:2:2 / 10 bit (HDMI)			
29.97 fps	4:2:2 / 10 bit (SD & HDMI)	h.264	ALL-I	200 Mbps
25.00 fps	4:2:2 / 10 bit (SD & HDMI)	h.264	ALL-I	200 Mbps
24.00 fps	4:2:2 / 10 bit (SD & HDMI)	h.264	ALL-I	200 Mbps
23.98 fps	4:2:2 / 10 bit (SD & HDMI)	h.264	ALL-I	200 Mbps
MOV FHD Slow Motion				
Sensor: 119.88 fps	4:2:0 / 10 bit (SD & HDMI)	h.265	L-GOP	100 Mbps
Recording/Playback: 29.97 fps				
Sensor: 100.00 fps	4:2:0 / 10 bit (SD & HDMI)	h.265	L-GOP	100 Mbps
Recording/Playback: 25.00 fps				
MOV FHD ProRes				
59.94 fps	422HQ	ProRes		454 Mbps
50.00 fps	422HQ	ProRes		378 Mbps
29.97 fps	422HQ	ProRes		227 Mbps
25.00 fps	422HQ	ProRes		189 Mbps
24.00 fps	422HQ	ProRes		182 Mbps
23.98 fps	422HQ	ProRes		181 Mbps
MP4 8K				
MP4 8K (recording to SD)				

29.97 fps	8K 4:2:0 / 10 bit	h.265	L-GOP	300 Mbps
25.00 fps	8K 4:2:0 / 10 bit	h.265	L-GOP	300 Mbps
23.98 fps	8K 4:2:0 / 10 bit	h.265	L-GOP	300 Mbps
MP4 8K (HDMI output without recording to SD)				
29.97 fps	8K 4:2:0 / 8 bit	h.265	L-GOP	300 Mbps
25.00 fps	8K 4:2:0 / 8 bit	h.265	L-GOP	300 Mbps
23.98 fps	8K 4:2:0 / 8 bit	h.265	L-GOP	300 Mbps
MP4 8K (HDMI output during recording to SD)				
29.97 fps	4K 4:2:2 / 10 bit	h.265	L-GOP	300 Mbps
25.00 fps	4K 4:2:2 / 10 bit	h.265	L-GOP	300 Mbps
23.98 fps	4K 4:2:2 / 10 bit	h.265	L-GOP	300 Mbps
MP4 4K				
59.94 fps	4:2:0 / 10 bit (SD & HDMI)	h.265	L-GOP	100 Mbps
50.00 fps	4:2:0 / 10 bit (SD & HDMI)	h.265	L-GOP	100 Mbps
29.97 fps	4:2:0 / 8 bit (SD & HDMI)	h.264	L-GOP	100 Mbps
25.00 fps	4:2:0 / 8 bit (SD & HDMI)	h.264	L-GOP	100 Mbps
23.98 fps	4:2:0 / 8 bit (SD & HDMI)	h.264	L-GOP	100 Mbps
MP4 FHD				
59.94 fps	4:2:0 / 8 bit (SD & HDMI)	h.264	L-GOP	28 Mbps
50.00 fps	4:2:0 / 8 bit (SD & HDMI)	h.264	L-GOP	28 Mbps
29.97 fps	4:2:0 / 8 bit (SD & HDMI)	h.264	L-GOP	20 Mbps
25.00 fps	4:2:0 / 8 bit (SD & HDMI)	h.264	L-GOP	20 Mbps
23.98 fps	4:2:0 / 8 bit (SD & HDMI)	h.264	L-GOP	24 Mbps

## Video Gamma

Rec. 709, L-Log Rec. 2020, HLG Rec. 2020

Further information can be found in the "L-Log Reference Manual" for download on the Leica homepage.

## VIEWFINDER/LCD PANEL

### Viewfinder (EVF)

Resolution: 5,760,000 dots, 60 fps or 120 fps, magnification: approx. 0.76x at aspect ratio: 3:2 / approx. 0.78x at aspect ratio: 4:3, frame coverage: 100%, exit pupil position: 21 mm, setting range -4/+2 dpt, with eye sensor for automatic switchover between viewfinder and LCD panel, time delay 0.005 s

### LCD panel

3.2" (backlight LED) with anti-fingerprint and anti-scratch coating, 2,332,800 dots, format 3:2, touch panel

**Top display**

1.28" highly reflective trans-reflective monochrome LCD, 128 x 128 pixels, viewing angle 120°, anti-fingerprint coating

**SHUTTER****Shutter type**

Electronically controlled focal plane shutter/electronic shutter

**Shutter speeds**

Mech. shutter: 60 min to 1/8000s

Electro. shutter function: 60s to 1/16000s

Flash Synchronization: up to 1/200s

**Shutter button**

Two-stage

(1st stage: Activation of the camera electronics including autofocus and exposure metering, 2nd stage: Taking the picture)

**Self-timer**

Delay time: 2s, 6s, 12s or 30s

**Drive mode**

Single, Continuous Shooting, Interval Shooting, Exposure Bracketing

Continuous shooting:

Setting	Shutter type	Autofocus mode for continuous shooting
2 fps, 14 bit, AF	Mech. or electr. shutter	AFc, even if AFs or Intelligent AF is selected
4 fps, 14 bit, AF		
5 fps, 12 bit, AF		
6 fps, 14 bit*		
7 fps, 12 bit*	Electr. shutter	No refocusing
9 fps, 12 bit*		
15 fps, 12 bit*		

\*Automatic settings (exposure settings in operating modes P/A/S, automatic white balance and autofocus) are implemented for the first frame, and are then applied for each subsequent frame in the same picture series.

**FOCUSING****Focusing range**

Lens-dependent

**Focus mode**

Automatic or manual

With manual setting: optional magnifying glass function (Magnification) and edge marking (Focus Peaking) available as focus assist

**Autofocus system**

Hybrid-AF due to combination of contrast metering, depth mapping, and phase comparison metering with AF metering points in the sensor.

**Autofocus modes**

Intelligent AF (automatically refocuses as soon as something changes in the scene), AFs, AFc, AF setting can be saved, optional Touch AF

**Autofocus metering methods**

Multi-field, Spot (can be shifted), Field (can be shifted and scaled), Zone (can be shifted and scaled), Tracking, Eye/Face/Body Detection, Animal Detection (Beta)

**Autofocus metering fields**

315

**EXPOSURE****Exposure metering**

TTL (exposure metering through the lens)

**Exposure metering methods**

Spot, Center-Weighted, Highlight-Weighted, Multi-Field

**Exposure modes**

Program AE mode (P)

Aperture-priority mode (A): manual aperture setting

Shutter-priority mode (S): manual shutter-speed setting

Manual (M): manual setting for shutter speed and aperture





### Exposure compensation

±3 EV in 1/3 EV increments or 1/2 EV increments

### Automatic bracketing

3 or 5 frames, graduations between shoots up to 3 EV, in 1/3 EV increments, additional optional exposure compensation: up to ±3 EV

### ISO sensitivity range

	Photo	Video	Video L-Log	HLG
Auto ISO	ISO 100– ISO 100 000	ISO 100– ISO 100 000	ISO 200– ISO 100 000	ISO 400– ISO 100 000
Manual	ISO 50– ISO 100 000	ISO 50– ISO 100 000	ISO 200– ISO 100 000	ISO 400– ISO 100 000

### Dual Basis ISO setting

	Photo	Video	Video L-Log	HLG
Low Base-ISO	ISO 50– ISO 280	ISO 50– ISO 280	ISO 200– ISO 560	ISO 400– ISO 1100
High Base-ISO	ISO 320– ISO 100 000	ISO 320– ISO 100 000	ISO 640– ISO 100 000	ISO 1200– ISO 100 000

### White balance

Automatic (Auto), default (Daylight, Cloudy, Shadow, Tungsten, HMI, Fluorescent (warm), Fluorescent (cool), Flash), manual metering (Gray Card (pipette), Gray Card), manual color temperature settings (Color Temperature, 2000 K to 11500 K)

### FLASH EXPOSURE CONTROL

#### Flash unit connector

Via the accessory shoe

#### Flash sync socket

For flash synchronization (photo mode only)

**Caution:** Do not connect and use flash units in Video mode!!

### Flash sync time

↔ : 1/200 s, slower shutter speeds available, automatic switchover to TTL linear flash mode with HSS-compatible Leica system flash units if sync time is undercut

### Flash exposure metering

Using center-weighted TTL pre-flash metering with Leica flash units (SF 26, SF 40, SF 58, SF 60, SF 64) or with system-compatible flash units, remote controlled flash SFC1

### Flash exposure compensation

SF 40: ±2 EV in 1/2 EV increments

SF 60: ±2 EV in 1/3 EV increments

### EQUIPMENT

#### Microphone

Stereo internal + microphone input 3.5 mm stereo jack

#### Speaker

Mono internal + headphones output 3.5 mm stereo jack

### WLAN

The Leica FOTOS app is required to use the WLAN function. The Leica app is available from the Apple App Store™ or the Google Play Store™.

	2.4 GHz	5 GHz
EU/ US/ CN	IEEE802.11b/g/n: Channel 1–11 (2412–2462 MHz)	Client mode: (For indoor use only) IEEE802.11a/n/ac: Channel 36–64 (5180–5320 MHz)
JP		Access point + client mode: (For indoor use only) IEEE802.11a/n/ac: Channel 36–48 (5180–5240 MHz)
ROW		Client mode: (For indoor use only) IEEE802.11a/n/ac: Channel 52–144 (5260–5720 MHz)

Encryption method: WLAN-compatible WPA2™



## GPS

Not available everywhere due to country-specific legislation; can be added via the Leica FOTOS app. Data is written to Exif header of the picture files.

## Bluetooth

Bluetooth 5.0 LE: Channel 0–39 (2402–2480 MHz)

## Menu languages

English, German, French, Italian, Spanish, Portuguese, Russian, Japanese, Simplified Chinese, Traditional Chinese, Korean

## POWER SUPPLY

### Rechargeable battery (Leica BP-SCL6)

Lithium-ion rechargeable battery, rated voltage: 7.2 V (DC); capacity: 2200 mAh (min.), 260 shots (based on CIPA standard), 1350 shots (based on CIPA standard with adapted shooting cycle\*) Manufacturer: Panasonic Energy (Wuxi) Co. Ltd., Made in China

### USB-C AC Adapter (Leica ACA-SCL6)

(optional)

Input: AC 100–240 V, 50/60 Hz, 0.25 A, automatic switchover; Output: DC 5 V/9 V, 3 A; Manufacturer: Salom Electric (Xiamen) Co., Ltd., Made in China

### Dual Charger (Leica BC-SCL6)

(optional)

Input: DC 5 V/3 A, 9 V/3 A, automatic switchover; Output: DC 8.4 V, 850 mA/1000 mA; Manufacturer: Salom Electric (Xiamen) Co., Ltd., Made in China

### Charging via USB

During operation: 9 V/3 A (min. 2.7 W)

With camera switched off: 5 V/1500 mA (2.5 W or greater)

\***Cycle 1:** Switch on, 1st shutter release after 5 s, one shot every 3 s, the camera switches off after 10 shots (Auto Power Off) and switched back on after a waiting time of 5 min.

\***Cycle 2:** Switch on, 1st shutter release after 5 s, one shot every 3 s, the camera switches off after 50 shots (Auto Power Off) and switched back on after a waiting time of 5 min.

These cycles are repeated alternately until the battery is empty.



QuickTime





## LEICA CUSTOMER CARE

Please contact the Customer Care department of Leica Camera AG for the maintenance of your Leica equipment and for help and advice regarding Leica products and how to order them. You can also contact the Customer Care department or the repair service provided by your regional Leica subsidiary for repairs or warranty claims.

### LEICA GERMANY

#### Leica Camera AG

Leica Customer Care  
Am Leitz-Park 5  
35578 Wetzlar  
Germany

**Phone:** +49(0)6441 2080-189

**Fax:** +49(0)6441 2080-339

**Email:** [customer.care@leica-camera.com](mailto:customer.care@leica-camera.com)

<https://leica-camera.com>

### YOUR NATIONAL REPRESENTATIVE

You will find the Customer Care department responsible for your locality on our homepage:

<https://leica-camera.com/en-US/contact>

## LEICA AKADEMIE

Have a look at our full seminar program with many interesting workshops on the topic of photography at:

<https://leica-camera.com/en-US/leica-akademie>