



LEICA SOFORT 2

Instruction manual



FOREWORD

Dear Customer,

We wish you a great deal of fun and success taking photographs with your new Leica Sofort 2. Please read this manual thoroughly to familiarize yourself with the full scope of functions your camera has to offer. You can find all information about the Leica Sofort 2 whenever you need it at <https://leica-camera.com>.

Your Leica Camera AG

SCOPE OF DELIVERY

Before using your camera for the first time, please check that the accessories supplied are complete.

- Leica Sofort 2
- USB cable (B038A34001)
- Carry strap
- Quick Start Guide
- Lens cap

* Subject to change with regard to construction and appearance.

REPLACEMENT PARTS / ACCESSORIES

Please contact Leica Customer Care or visit the Leica Camera AG website for information on the extensive range of Leica replacement parts/accessories:

<https://leica-camera.com/en-US/photography/accessories>

Only the accessories specified and described in this manual or by Leica Camera AG must be used with the camera (battery, charger, mains plug, mains cable, etc.). These accessories must only be used with this product. Third-party accessories may result in malfunctions or damage to the product.

Please read the chapters “Legal information”, “Safety remarks”, and “General information” before using your camera for the first time. Knowledge of the content will prevent inadvertent damage to the product, possible injuries and other risks.



Definition of the various categories of information found in this manual

Note

Additional information

Important

Failure to comply with instructions may result in damage to the camera, the accessories or the data files

Attention

Non-compliance may result in personal injury



LEGAL INFORMATION

COPYRIGHT NOTICE

- Compliance with copyright laws is mandatory. The recording and publication of pre-recorded media like tapes, CDs, or other published or broadcast material may breach copyright laws. The same applies for all software supplied as part of the scope of delivery.
- The designations SD, SDHC, SDXC, microSDHC and their associated logos are registered trademarks of SD-3C, LLC.

LEGAL INFORMATION ABOUT THIS MANUAL

COPYRIGHT

All rights reserved.

All text, images and graphics are subject to copyright and other laws to protect intellectual property. They must not be copied, modified or used for any purpose including trade purposes.

TECHNICAL DATA

Product changes with regards to the product or services may have occurred after the editorial deadline. The manufacturer reserves the right to effect structural or shape changes, color deviations and changes to the scope of delivery or service, where these changes or deviations are reasonably acceptable for the customer, while taking into consideration the interests of Leica Camera AG. To that extent, Leica Camera AG reserves the right to changes and errors. The images in this manual may depict accessory, special features or other items that are not part of the standard scope of delivery or service. Some pages may contain model types and services, which are not offered in specific countries.

BRANDS AND LOGOS

The brand names and logos used in this document are protected trademarks. These brands or logos must not be used without prior approval by Leica Camera AG.

LICENSE RIGHTS

Leica Camera AG intends to provide you with innovative and informative documentation. Due to the amount of creativity that has gone into its design, we ask for your understanding that Leica Camera AG must protect its intellectual property, including patents, trademarks and copyrights, and that possession of the documentation does not infer any licensing rights of the intellectual property of Leica Camera AG.

REGULATORY INFORMATION

You will find the manufacturing date of your camera on the stickers in the Warranty Card and/or on the packaging.

The date format is year/month/day.

CE MARK

The CE mark on our products documents compliance with the fundamental requirements of applicable EU guidelines.

English

Declaration of Conformity (DoC)

"Leica Camera AG" hereby declares that this product is in compliance with the basic requirements and other relevant provisions of Directive 2014/53/EU.

Customers can download a copy of the original DoC for our Radio Equipment products from our DoC server:

<https://cert.leica-camera.com>

Please contact Leica Camera AG, Am Leitz-Park 5, 35578 Wetzlar, Germany in case of any further questions

Usable frequency band/ Usage limitations:

see technical data

DISPOSAL OF ELECTRICAL AND ELECTRONIC EQUIPMENT

(Applies within the EU and for other European countries with active waste separation policies.)



This device contains electrical and/or electronic components which must not be disposed of in general household waste. Instead, it should be disposed of at a recycling collection point provided by your local authority.

This service is free of charge. Any standard or rechargeable batteries used in this device must be removed and disposed of separately in accordance with local regulations.

Please contact your local authorities, waste disposal collection point or the retailer, from whom you purchased the device for more information on correct waste disposal.



IMPORTANT NOTES REGARDING THE USE OF WLAN/BLUETOOTH®

- Appropriate measures must be taken to ensure security and protect against disruptions to the systems in place where devices or computer systems are in use that require more stringent security than WLAN devices.
 - Leica Camera AG shall not accept liability for damages arising from the use of the camera for purposes other than as a WLAN device.
 - It is assumed that the WLAN function will be used in countries where this camera is sold. There may be a risk of breaching statutory wireless communication regulations when using the camera in other countries. Leica Camera AG shall not accept liability for such breaches.
 - Please note that there is a risk of unauthorized third party interception of wirelessly communicated data. We highly recommend that you activate encryption in the wireless access point settings to ensure data safety.
 - Avoid using the camera in areas where it can be exposed to magnetic fields, static electricity or other interferences, e.g. near a microwave oven. RF transmissions may otherwise not reach the camera.
 - Using the camera near devices like microwave ovens or wireless phones that use the 2.4 GHz RF band may negatively affect the performance of both devices.
 - Do not attempt to connect to wireless networks you are not authorized to use.
 - The device will automatically search for wireless networks, once the WLAN function is enabled. A list, including networks you are not authorized to access, will be displayed (SSID: Network identifier for a WLAN network). Do not attempt to connect to third party network, as this could be construed as unauthorized access.
- We recommend disabling the WLAN function while on an aircraft.
 - The use of the WLAN-RF band between 5150 MHz and 5350 MHz is permitted only in enclosed spaces.
 - Please read the important notes on specific functions of Leica FOTOS on p. 72.



SAFETY REMARKS

GENERAL INFORMATION

- Do not use your camera in the immediate vicinity of devices that generate powerful magnetic, electrostatic or electromagnetic fields (e.g. induction ovens, microwave ovens, television sets or computer screens, video game consoles, cell phones, broadcasting equipment). Their electromagnetic fields can interfere with image capturing.
- Strong magnetic fields, e.g. from speakers or large electric motors can damage the stored data or disrupt shooting.
- Switch off the camera, remove the battery briefly, replace it and switch the camera back on in case of a camera malfunction due to the effects of electromagnetic fields.
- Always store small parts e.g. the accessory shoe cover as follows:
 - out of the reach of children
 - in a safe location, where they will not get lost or stolen
- State-of-the-art electronic components are sensitive to static discharge. You can easily pick up charges of several 10,000 volts by simply walking on synthetic floor coverings. A static discharge can occur when you touch the camera and especially if it is placed on a conductive surface. A static discharge on the camera housing poses no risk for the electronics. Despite built-in safety circuits, you should avoid direct contact with external camera contacts like those in the flash shoe.
- Only use accessories specified for this model to prevent faults, short circuits or electric shock.
- Do not attempt to remove parts of the housing (covers) yourself. Repairs must be done at authorized service centers only.

- Prevent any sand or dust or water penetration into the camera, e.g. during snowfall or rain or on the beach. Be extra careful when changing the lens (in system cameras) and when inserting or removing the memory card and rechargeable battery. Sand and dust can damage the camera, the lens, the memory card and the battery. Moisture can cause malfunctions and irreparable damage to the camera and memory card.

LENS

- A camera lens can have the effect of a magnifying glass when exposed to direct frontal sunlight. The camera must therefore be protected against extended exposure to direct sunlight. Attaching the lens cap and keeping the camera in the shade or ideally in its camera case, will help prevent damage to the interior of the camera.

RECHARGEABLE BATTERY

- New batteries must be charged before initial use to be ready for activation in the camera. A full charge is recommended, as the batteries are delivered in an only partially charged state.
- Never throw batteries into a fire as they may explode.
- Keep the battery away from sources of heat in case of leakage or if you smell burning. Leaked fluid can catch fire!
- The use of other chargers not approved by Leica Camera AG can cause damage to the batteries – and in extreme cases – cause serious or life-threatening injuries.
- Make sure that the power socket is freely accessible at all times.
- Do not attempt to open the battery or the charger. Repairs must only be carried out by authorized workshops.

FIRST AID

- Battery fluid may cause blindness if it comes into contact with the eyes. Rinse the eyes thoroughly with clean water immediately. Avoid rubbing. Seek medical attention immediately.
- Leaked battery fluid poses an injury hazard when it comes in contact with clothing or skin. Rinse the affected areas thoroughly with clean water.

CHARGER

- Using the charger in the vicinity of broadcasting receivers may interfere with reception. Ensure a distance of at least 1 m between the charger and the receiver.
- When the charger is in use, it may emit a buzzing sound – that is normal and not a malfunction.
- Disconnect the charger from the mains when it is not in use, as it consumes electricity (a very small amount), even if no battery is inserted.
- Always keep the charger contacts clean, and never short-circuit them.

MEMORY CARD

- Never remove the memory card during a data save or card reading process. The camera must not be switched off or be subjected to impact or vibrations while working.
- Do not open the cover/remove the memory card or the battery from the camera while the status LED is lit, which indicates memory access. Data on the card may otherwise be destroyed and camera malfunctions may occur.
- Do not drop or bend memory cards as this will cause damage and result in the loss of stored data.

- Do not touch the connections on the reverse of the memory card and keep them clean and dry.
- Keep memory cards out of the reach of children. Swallowing a memory card may cause suffocation.

SENSOR

- Cosmic radiation (e.g. during flights) may cause pixel defects.

CARRY STRAP

- Carry straps are usually made of very robust material. You should therefore keep it out of the reach of children. A carry strap is not a toy and poses a strangulation risk.
- Use the carry strap only for its intended purpose on a camera or on binoculars. Any other use poses the risk of injury and may possibly result in damage to the carry strap and is therefore not permitted.
- Carry straps should also not be used for cameras/binoculars during sports activities that pose a risk of entanglement (e.g. when mountain climbing and similar outdoor activities).

TRIPOD

- When using a tripod, make sure it is standing securely and turn the camera only by turning the tripod, not the actual camera. Ensure that the tripod screw is hand-tightened only. Avoid transporting the camera while the tripod is attached. You might injure yourself or others and the camera could get damaged.



FILM PACKS AND PRINTS

- Keep prints out of the reach of children. Please also note the information contained in the documentation accompanying each film pack.

BLUETOOTH

- Wirelessly transmitted data (images) may be intercepted by third parties. The safety of data transmitted via wireless networks cannot be guaranteed.
- Do not use the device in areas where it may be exposed to magnetic fields, static electricity, or radio frequency interference (RFI).
- Do not use the transmitter in the immediate vicinity of microwave ovens or other devices, where the reception of wireless signals may be disrupted by magnetic fields, static electricity, or RFI. Other wireless devices operating in the 2.4 GHz band in the vicinity of the device may cause mutual interference.
- The Bluetooth transmitter operates in the 2.4 GHz frequency band. The standard output strength is approx. 3.16 mW.



GENERAL INFORMATION

Please read the section about “Care/Storage” for more information about what to do in case of problems.

CAMERA/LENS

- Make a note of the serial numbers of your camera and lenses, as this information will be extremely important in case of loss.
- Depending on model, you will find the serial number of your camera on the flash shoe or engraved in the underside of the camera.
- Never store the camera bayonet cover or the lens back cover in a pants pocket, as they will attract lint and dust, which could then be accidentally introduced into the camera.

LCD PANEL

- Condensation may form on the LCD panel if the camera is exposed to great temperature fluctuations. Wipe the screen carefully with a soft, dry cloth.
- The screen image will initially be slightly darker than normal if the camera is very cold when it is switched on. The normal level of brightness will be reached as soon as the LCD panel warms up.

RECHARGEABLE BATTERY

- The rechargeable battery must only be charged within a specific temperature range. See chapter “Technical Data” (p. 82) for details about operating conditions.
- Lithium-ion batteries can be charged at any time, regardless of their current charge level. A partially charged battery will charge to full capacity faster than a fully discharged one.
- The rechargeable batteries come only partly charged ex works and should therefore be charged fully before their first use.

- A new battery only reaches its full capacity after it has been fully charged and – by using it in the camera – depleted 2 to 3 times. This depletion process should be repeated roughly every 25 cycles.
- Battery and charger heat up during the charging process. That is normal and not a malfunction.
- Rechargeable lithium-ion batteries generate power by way of internal chemical reactions. These reactions are influenced by ambient temperature and humidity. Do not expose the battery to extreme temperatures (high or low) for extended periods of time (e.g. in a parked car in the summer or winter) to ensure a maximum service life.
- However, every battery has its limits – even in optimal conditions! After several hundred charging cycles, the operating times will get significantly shorter.

MEMORY CARD

- The range of available microSD/SDHC/SDXC cards on the market is too extensive for Leica Camera AG to test for compatibility and quality. Generally, any type of memory card may be used without any damage to the camera or memory card. As some “no name” cards may not fully comply with the SD/SDHC/SDXC standards, Leica Camera AG cannot provide any guarantee of function.
- We recommend formatting the memory card from time to time, as fragmented residual data from deleted files may block some of the storage capacity.
- Generally, it is not necessary to format (initialize) memory cards that have been previously used. Formatting will, however, be necessary if you insert an unformatted memory card or a card that was formatted in another device (e.g. a computer) for the first time.

- We recommend backing up your data on a PC, because electro-magnetic fields, static electricity and any damage to the memory card or camera defects may result in irretrievable damage or loss of your data.
- SD, SDHC, and SDXC memory cards come with a write protection slider to prevent accidental overwriting. This slider is located on the non-beveled side of the card. All data on the card is protected when the slider is set to its lower position, marked LOCK.
- All data stored on the memory card will be lost during formatting. Formatting will not be prevented by a deletion protection set for individual shots.

SENSOR

- Any dust or dirt particles stuck to the glass cover of the sensor may result in noticeable dark stains or specks on the images (in system cameras). Alternatively, send your camera to the Leica Customer Care department for sensor cleaning (see p. 86). This service is not part of the warranty offering and will therefore incur charges.

DATA

- All data, including personal information, may be changed or deleted due to incorrect or accidental operation, static discharge, accidents, malfunctions, repairs and other measures.
- Please note that Leica Camera AG does NOT accept liability for direct or consequential damage due to the manipulation or destruction of data and personal information.

FIRMWARE UPDATE

Leica is continuously working on the further improvement and optimization of Leica Sofort 2. As digital cameras have many functions that are controlled electronically, improvements and enhancements to the functions can be installed on the camera retroactively. Leica releases so-called firmware updates at irregular intervals. Cameras are always supplied ex works with the latest firmware installed or you can download the latest version from our website yourself and transfer it to your camera.

You will receive a newsletter informing you of the availability of a new firmware update if you register your camera on the Leica Camera homepage.

Visit the download section or the “Customer Area” for information about how to register or how to get firmware updates for your Leica Sofort 2. Additionally, you can find information about changes or additions to the manual at: <https://club.leica-camera.com>

WARRANTY TERMS LEICA CAMERA AG

Dear Leica Customer,

congratulations on the purchase of your new Leica product – you are now the proud owner of a world-class brand product.

In addition to your statutory warranty claims against your seller, we, Leica Camera AG ("LEICA"), grant you voluntary warranty services for your Leica product in accordance with the following stipulations ("Leica Warranty"). The Leica warranty therefore does not limit your statutory rights as a consumer under applicable law or your rights as a consumer against the dealer with whom you have concluded the purchase contract.

LEICA WARRANTY

You have purchased a Leica product that has been manufactured according to special quality guidelines and tested by experienced specialists during the various stages of production. We provide the following Leica Warranty, valid as of April 1, 2023, for this Leica product and including the accessory parts in the original packaging. Please note that we do not offer any warranty for commercial use. We offer an extended warranty for some Leica products, provided you register for a Leica account. Please visit www.leica-camera.com for more details.

LEICA WARRANTY SCOPE

During the warranty period, complaints based on manufacturing and material defects will be remedied free of charge, at LEICA's discretion, by way of repair, replacement of defective parts, or exchange for a similar Leica product in perfect condition. Replaced parts or products become the property of LEICA.

Further claims of any kind and on any legal grounds whatsoever in connection with this Leica Warranty are excluded.

EXCLUDED FROM THE LEICA WARRANTY

Parts subject to wear and tear (e.g. eyecups, leather coverings, carry straps, armoring, batteries), and parts under mechanical stress are excluded from the Leica Warranty, unless the defect was caused by manufacturing or material defects. That also applies to any exterior damage.

VOIDED CLAIMS UNDER LEICA WARRANTY

Claims under the warranty are void if the defect in question is due to improper handling; they may also be void if e.g. third-party accessories have been used, the Leica product has not been opened professionally or has not been repaired professionally. Claims for warranty services shall similarly be void if the serial number is unrecognizable.

CLAIMS UNDER THE LEICA WARRANTY

We require a copy of the proof of purchase of your Leica product from a LEICA-authorized dealer ("Authorized Leica Dealer") before we can accept any claim under the warranty. The purchase receipt must show the date of purchase, the Leica product with its article number and serial number, and details about the Authorized Leica Dealer. We reserve the right to request the original receipt. Alternatively, you may send us a copy of the warranty card; please note that the Warranty Card must be filled out correctly, and the product must have been purchased from an Authorized Leica Dealer.

Please send your Leica product with a copy of your purchase receipt or the Warranty Card alongside a description of the issue.

Leica Camera AG, Customer Care, Am Leitz-Park 5, 35578 Wetzlar, Germany

Email: customer.care@leica-camera.com, phone: +49(0)6441 2080-189

or to an Authorized Leica Dealer.

Leica Product Image	Warranty Term
all products	2 years

TABLE OF CONTENTS

FOREWORD.....	2	CHANGING THE FILM PACK	26
SCOPE OF DELIVERY	2	INSERTION	26
REPLACEMENT PARTS / ACCESSORIES	3	REMOVING	27
LEGAL INFORMATION.....	4	CAMERA OPERATION	28
SAFETY REMARKS	8	CONTROL ELEMENTS	28
GENERAL INFORMATION	8	MAIN SWITCH	28
LENS.....	8	SHUTTER BUTTON.....	29
RECHARGEABLE BATTERY	8	“FILM EFFEKT” DIAL.....	30
CHARGER.....	9	“OPTICAL EFFECT” DIAL	30
MEMORY CARD.....	9	EFFECTS RESET BUTTON.....	31
SENSOR	9	DIRECTIONAL PAD / MENU/OK BUTTON	31
CARRY STRAP.....	9	PLAY BUTTON / BACK BUTTON / FN BUTTON.....	32
TRIPOD.....	9	LCD PANEL	32
FILM PACKS AND PRINTS.....	10	PRINT LEVER	32
BLUETOOTH	10	MENU CONTROL.....	33
GENERAL INFORMATION	12	CONTROL ELEMENTS.....	33
WARRANTY TERMS LEICA CAMERA AG	14	MENU SECTIONS	33
TABLE OF CONTENTS	16	ICON MENU.....	34
PART DESIGNATIONS	18	LIST MENU	36
DISPLAYS	20	MENU NAVIGATION.....	37
PREPARATION	24	CAMERA BASIC SETTINGS.....	38
ATTACHING THE HAND STRAP	24	MENU LANGUAGE.....	38
CHARGING THE BATTERY	24	TIME/DATE	38
CHARGING VIA USB	24	POWER SAVE MODE (STANDBY MODE).....	39
INSERTING/REMOVING THE MEMORY CARD	25	ACOUSTIC SIGNALS	39
		OPERATION SOUND	39
		ELECTRONIC SHUTTER SOUND	39
		START UP SOUND	39
		SILENT PHOTOGRAPHY	40
		STILL IMAGE SETTINGS.....	42
		FILM EFFECT	42

OPTICAL EFFECT.....	43	SELECTING/SCROLLING THROUGH IMAGES.....	58
SAVE EFFECTS COMBINATION	44	INFO DISPLAYS IN REVIEW MODE.....	58
DATE STAMP.....	44	CROPPED SECTION ZOOM	59
DATA MANAGEMENT.....	45	DISPLAYING MULTIPLE IMAGES AT ONCE.....	59
FORMATTING A MEMORY CARD	45	DELETING IMAGES.....	60
DATA TRANSFER.....	46	DELETING INDIVIDUAL IMAGES.....	61
ABOUT LEICA FOTOS	46	DELETING ALL IMAGES.....	62
PHOTOGRAPHY.....	48	ROTATING IMAGE.....	63
FOCUSING.....	48	MOVING IMAGE SECTION.....	64
AF PHOTOGRAPHY.....	48	CROPPING IMAGE SECTION.....	64
DIGITAL ZOOM	48	COPYING IMAGES.....	65
FACE DETECTION.....	49	DELETING PRINTED IMAGES.....	66
AF ASSIST LAMP.....	49	TRANSFERING PRINTED IMAGES.....	66
ACOUSTIC AF CONFIRMATION.....	49	OTHER FUNCTIONS	68
MACRO FUNCTION.....	50	RESETTING THE CAMERA TO FACTORY SETTINGS.....	68
WHITE BALANCE	50	FIRMWARE UPDATES	69
AUTOMATIC CONTROL/FIXED SETTINGS.....	51	EXECUTING A FIRMWARE UPDATE	70
EXPOSURE.....	51	LEICA FOTOS	72
EXPOSURE COMPENSATION.....	51	CONNECTION.....	72
SHOOTING MODES.....	52	FIRST-TIME CONNECTION TO A MOBILE DEVICE.....	72
SELF-TIMER.....	52	SKIP FIRST PAIRING	73
FLASH PHOTOGRAPHY.....	53	CONNECTING WITH PAIRED DEVICES.....	73
PHOTOGRAPHY WITHOUT FLASH (FLASH SUPPRESSION)	53	EXECUTING A FIRMWARE UPDATE	74
PRINTING	54	CARE/STORAGE	76
PRINT MODE	55	FAQ	78
PRINT BRIGHTNESS.....	55	TECHNICAL DATA	84
REVIEW MODE.....	56	LEICA CUSTOMER CARE.....	88
CONTROL ELEMENTS IN REVIEW MODE	56	LEICA AKADEMIE	89
DIRECT ACCESS IN REVIEW MODE.....	57		
STARTING/EXITING REVIEW MODE.....	57		

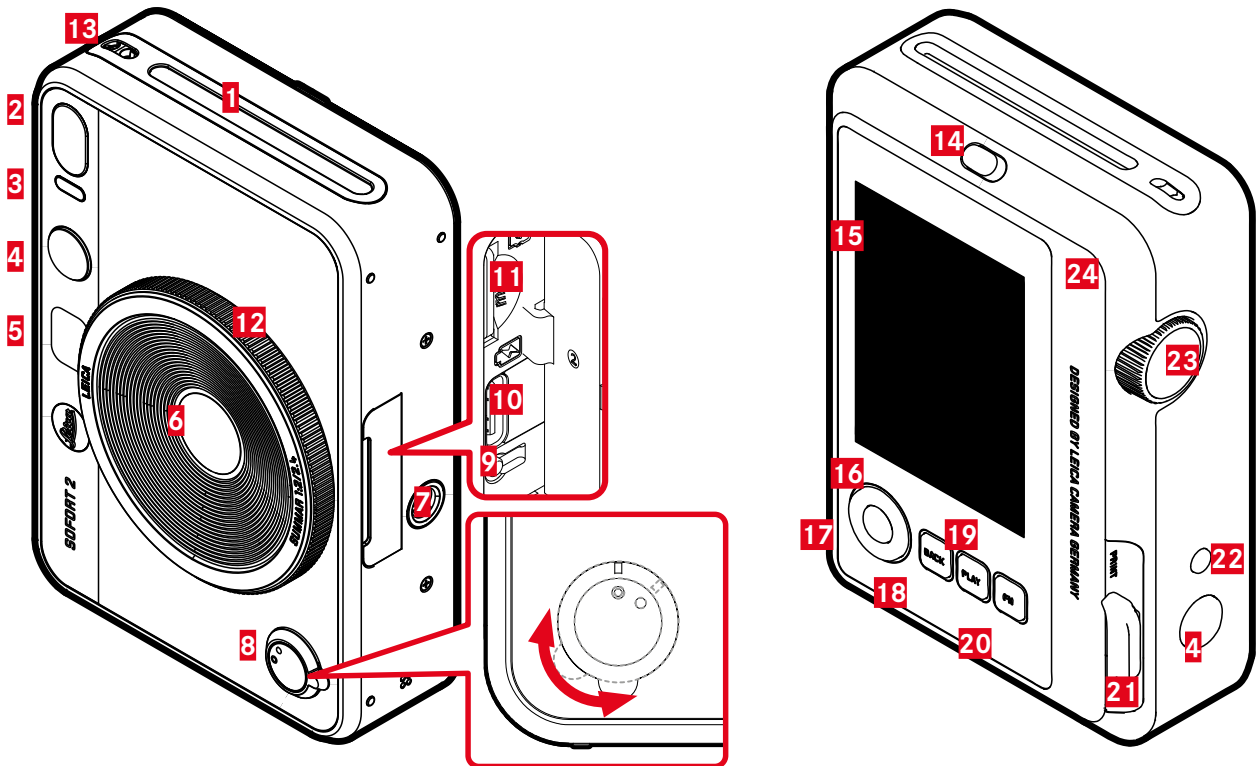

LEICA SOFORT 2

- 1** Film ejection slot
- 2** Flash
- 3** Self-timer LED/Charge status LED
- 4** Shutter button
- 5** Selfie mirror
- 6** Lens: Leica Summar 2.4 f/2
- 7** Tripod thread
- 8** Main switch
- 9** Restart button
- 10** USB-C port
- 11** Memory card slot (MicroSD)
- 12** "Optical effect" dial
- 13** Strap lugs
- 14** Rear cover lock
- 15** LCD panel
- 16** Directional pad
- 17** MENU/OK button
- 18** BACK button
- 19** PLAY button
- 20** FN button
- 21** Print lever
- 22** "Effects reset" button
- 23** "Film effect" dial
- 24** Rear cover (hinged)



DISPLAYS

STATUS SCREEN

- ▶ Press the **BACK** button
 - Additional display is shown.

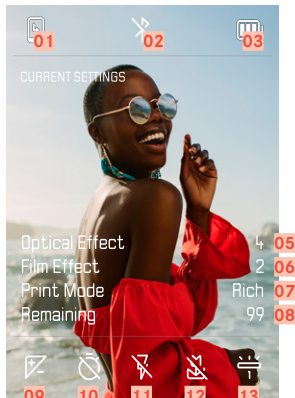

IN REVIEW MODE

All displays/values refer to the displayed image.

- ▶ Press the **BACK** button
 - Additional display is shown.



01 Remaining capacity: film pack

02 Bluetooth® (Leica FOTOS)

03 Battery capacity

04 File number of the image shown

05 Active "optical effect"

06 Active "film effect"

07 Print Mode

08 Remaining capacity: memory card

09 Exposure compensation

10 Self-timer

11 Flash mode

12 Macro mode

13 White balance mode



CAPTURE MENU

in capture mode:

- ▶ Press the **MENU/OK** button

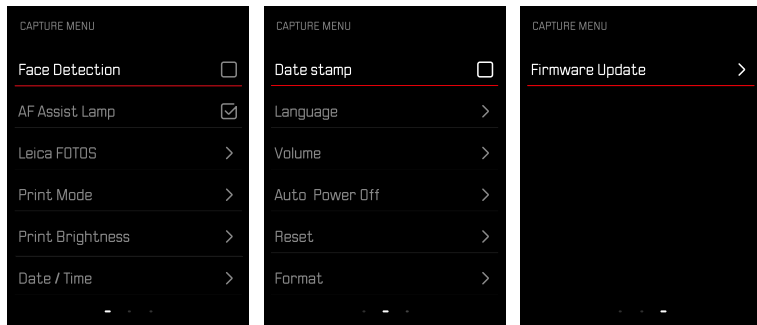

PLAY MENU

in review mode:

- ▶ Press the **MENU/OK** button

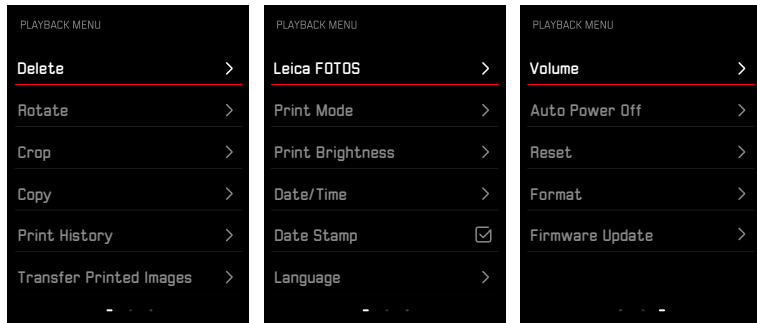



CHARGE STATUS INDICATOR ON THE LCD PANEL

The battery charge status is displayed in the status screen and in the header line at the top right.

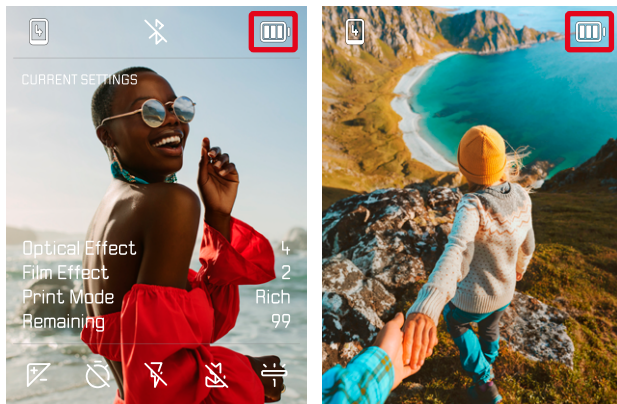

Display	Charge status
	Approx. 80 - 100%
	Approx. 50 - 79%
	Approx. 20 - 49%
	Approx. 0% The battery needs charging





PREPARATION

Please read the chapters “Legal information”, “Safety remarks”, and “General information” before using your camera for the first time. Knowledge of the content will prevent inadvertent damage to the product, possible injuries and other risks.

ATTACHING THE HAND STRAP

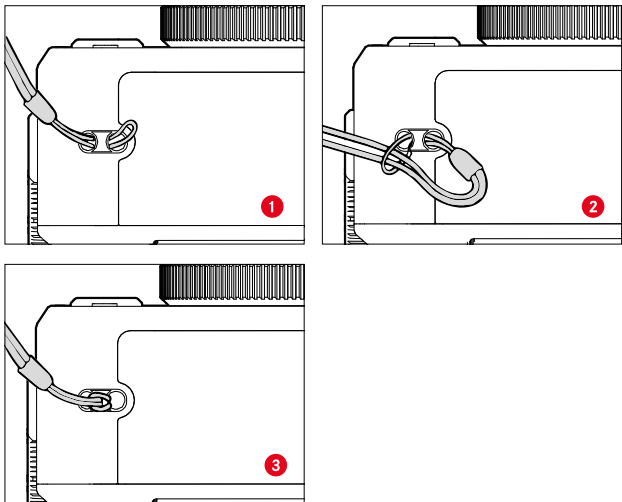

CHARGING THE BATTERY

The camera is powered by a lithium-ion battery.

CHARGING VIA USB

The rechargeable battery built into the camera can be automatically charged when the camera is connected to a computer or another suitable power source via USB cable.

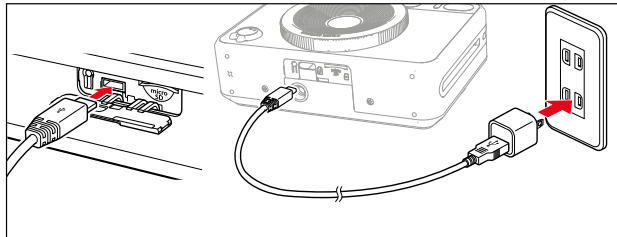

- ▶ Switch off the camera
- ▶ Inserting the USB-C cable (see Fig. above)

Note

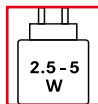

The charger output must be min. between 2.5W and max. 5.0W to ensure max. charging speed.

INSERTING/REMOVING THE MEMORY CARD

The camera can save images to an microSD (Secure Digital), SDHC (High Capacity) or SDXC (eXtended Capacity) memory card.

Notes

- microSD/SDHC/SDXC memory cards are available from various suppliers in a range of sizes and with differing read/write speeds. Memory cards with high storage capacities and high read/write speeds offer quick storage and rendering.
- The memory card may not be supported (capacity) or will have to be formatted in the camera before first use (see p. 45). The camera will in that case display a relevant message. Please see the section “Technical Data” for information about supported cards.
- Check the memory card for correct alignment if you are having difficulties inserting it into the camera.
- microSD card is not included in the delivery package.

OPENING THE COVER OVER THE MEMORY CARD SLOT

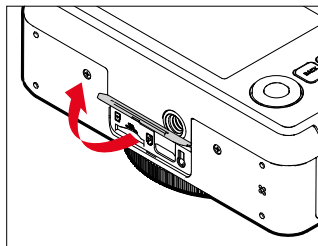

- ▶ Ensure that the camera is switched OFF (see p. 28)
- ▶ Flip open the cover as shown in the illustration



INSERTION

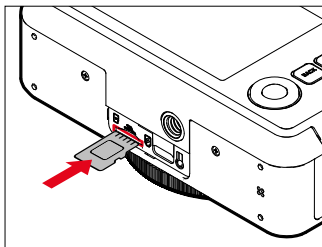

- ▶ Push the memory card into the slot with the contacts pointing towards the lens until you hear and feel it clicking into place

REMOVAL

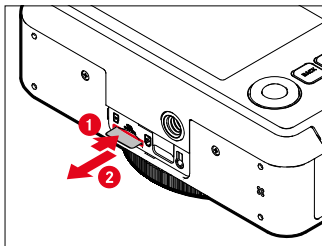

- ▶ Push down on the card until you hear a click
 - The card pushes out slightly.
- ▶ Remove the memory card

CHANGING THE FILM PACK

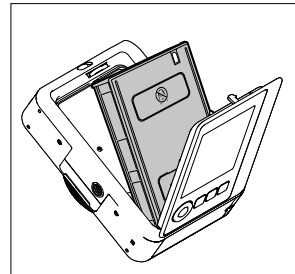
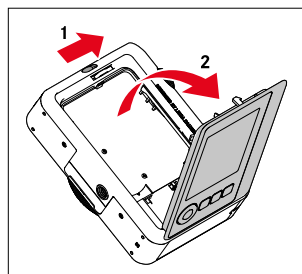

INSERTION

- ▶ Unlock and open the rear cover
- ▶ Grab the film pack on both sides
- ▶ Align the markings inside the camera (yellow) with those on the film pack
- ▶ Slide the film pack straight in
- ▶ Close the rear cover until the rear cover lock engages
- ▶ Remove the cover sheet

Important

- **Do not open the rear panel while the film transport is audibly in operation!**

REMOVING

- ▶ Unlock and open the rear cover
- ▶ Grab the film pack on the two rectangular recesses on the back and pull it straight out

Important

- **Do not open the rear panel while the film transport is audibly in operation!**
- Do not open the rear cover before the film pack is used up completely; doing so would expose the rest of the film, which would make it unusable.
- Do not press down on the two rectangular recesses on the back of the film pack when inserting the film pack.
- Use Leica Sofort color film only. These are available in 2 versions: Sofort color film pack (mini) Warm White: 19677 and Sofort color film pack (mini) Neo Gold: 19678





CAMERA OPERATION

CONTROL ELEMENTS

MAIN SWITCH

The main switch switches the camera on and off.

SWITCHING THE CAMERA ON

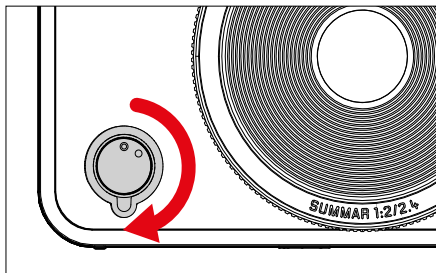

Note

- Once switched on, the camera will be ready to use after approx. 1 s.

SWITCHING THE CAMERA OFF

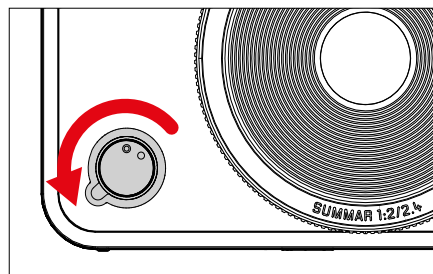

Note

- The function **Auto Power Off** deactivates the camera automatically if no operation occurs within a preset time. Use the main switch to deactivate the camera if this function is **Off** to prevent inadvertent exposures and battery discharge when the camera is not in use.

SHUTTER BUTTON

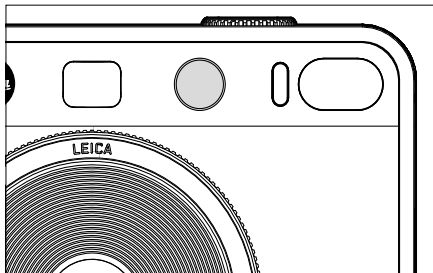
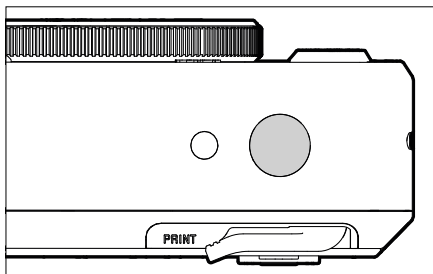

The shutter button works in two stages.

1. **Tapping** (= Pressing the shutter button to the 1st pressure point)
 - Activating the camera electronics and displays
 - Exposure lock (metering & saving):
 - AF mode: range measurement
 - (semi) automatic exposure mode: exposure metering
 - Return to shooting mode
 - from review mode
 - from menu control
2. **Press down fully**
 - Shutter release
 - The data is then transferred to the memory card or internal memory.
 - Starting a preselected self-timer delay time

Notes

- Press down the shutter button in a smooth motion until you hear the click of the shutter to prevent camera shake.
- The shutter button remains locked:
 - if the memory card inserted and/or the internal buffer memory are (temporarily) full
 - if the battery has exceeded its performance limits (capacity, temperature, age)
 - if the memory card is write-protected or damaged

“FILM EFFEKT” DIAL

The “Film effect” dial has no stop, which means it can be turned in either direction from any position. It will click at each function. It activates a menu of 10 adjustable effects. See p. 43.

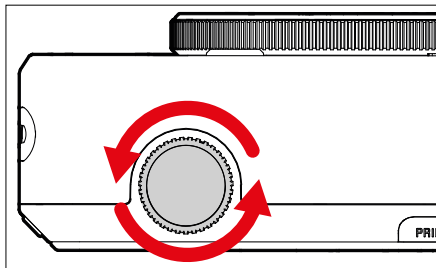

“OPTICAL EFFECT” DIAL

The “Optical effect” dial also has no stop, which means it can be turned in either direction from any position. It calls up a menu with 10 additional “Optical effect” for image composition. See p. 42.

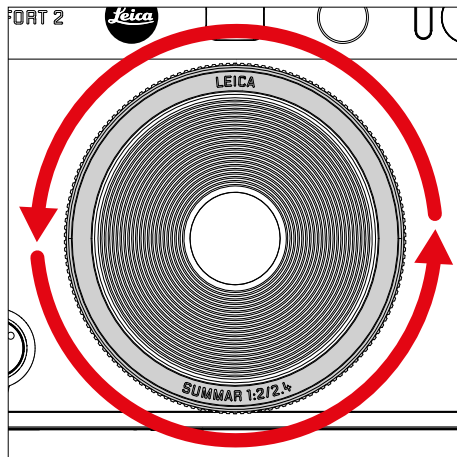

EFFECTS RESET BUTTON

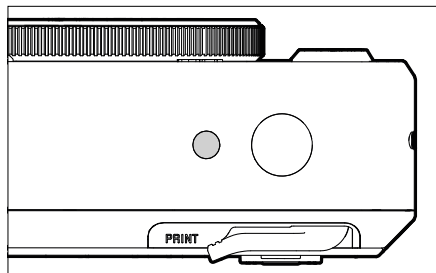

- Resetting the selected effects

DIRECTIONAL PAD / MENU/OK BUTTON

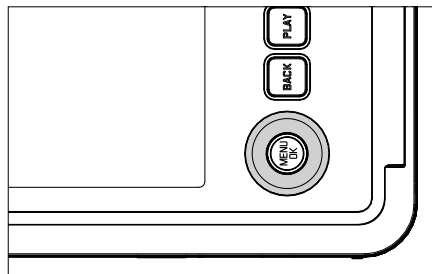

DIRECTIONAL PAD

- Menu navigation
- Setting selected menu items/functions
- Scrolling through the gallery

MENU/OK BUTTON

- Accessing the submenu
- Applying menu settings
- Confirming the prompts
- Direct access to menu functions





PLAY BUTTON / BACK BUTTON / FN BUTTON

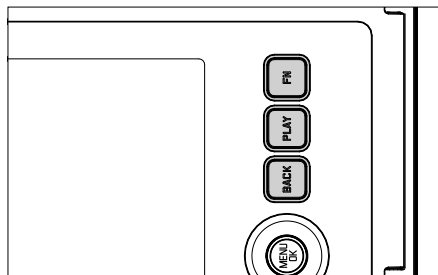

FN BUTTON

- Save selected "Optical effect" and "Film effect"
- Call up saved combination of "Optical effect" and "Film effect"

PLAY BUTTON

- Activation and deactivation of the (continuous) review mode

BACK BUTTON

- Accessing the information display
- Displaying settings/data in shooting mode
- Displaying image data in review mode
- Exiting a submenu

LCD PANEL



- Displaying most important current settings
- Quick access to some menus

PRINT LEVER

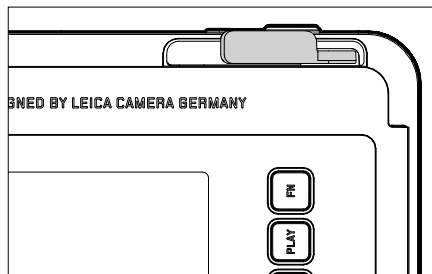

- Starts the printing process of a previously selected image

MENU CONTROL

CONTROL ELEMENTS

The following elements are used for menu control.

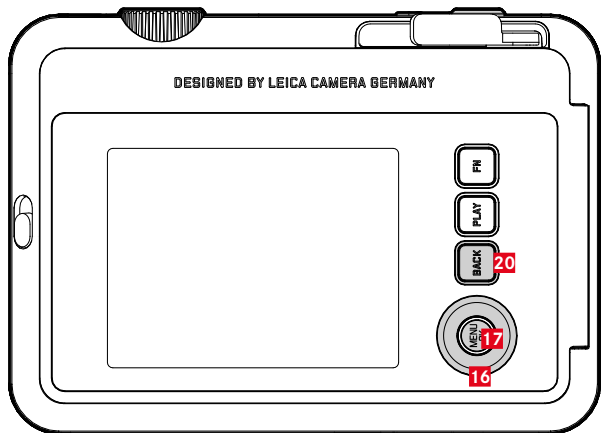

20 FN button

17 MENU/OK button

16 Directional pad

MENU SECTIONS

The following menu sections are available: Icon menu and List menu (CAPTURE MENU and PLAYBACK MENU).

Icon menu:

- quick access to the most important settings

List menu:

- offers access to all menu items
- contains various submenus

ICON MENU

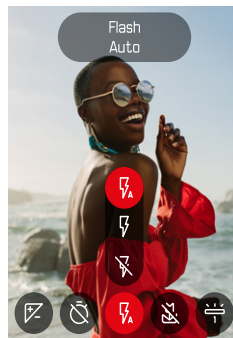

LIST MENU

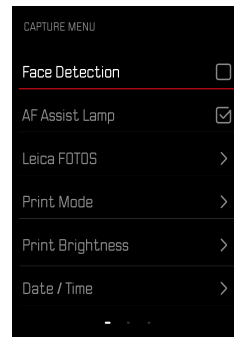



ICON MENU

The status screen offers an overview of the most important information regarding the current camera status and active settings. It furthermore allows direct access to important settings.

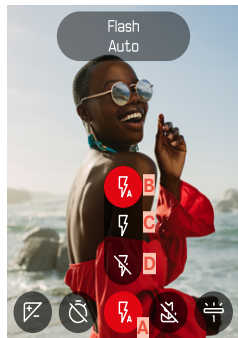

- A Menu item: flash settings
- B Auto
- C On
- D Off

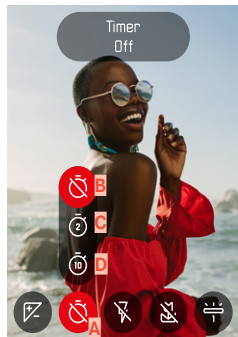

- A Menu item: self-timer
- B Off
- C 2 s
- D 10 s

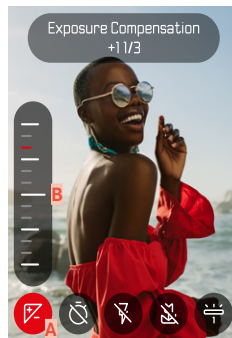

- A Menu item: exposure compensation
- B Exposure compensation scale

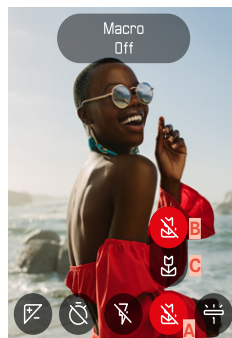

- A Menu item: macro setting
- B Off
- C On

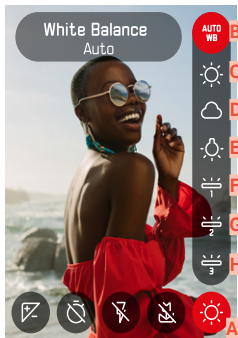

A Menu item: white balance

B Auto

C Daylight

D Cloudy

E Tungsten

F Fluorescent 1

G Fluorescent 2

H Fluorescent 3

Note

- The settings become effective immediately.

SELECTING SETTINGS

Accessing the icon menu

- ▶ Press the directional pad left/right

Selecting a menu item

- ▶ Press the directional pad left/right

Applying the desired setting

- ▶ Press the directional pad up/down

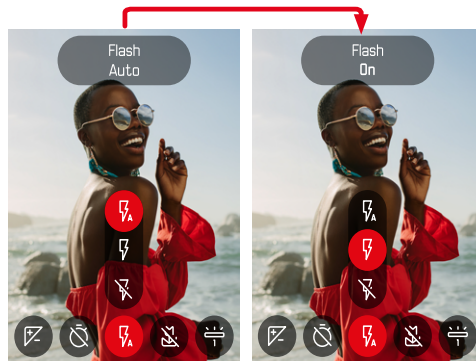



LIST MENU

The list menu offers access to all settings. Most of these are organized in submenus.

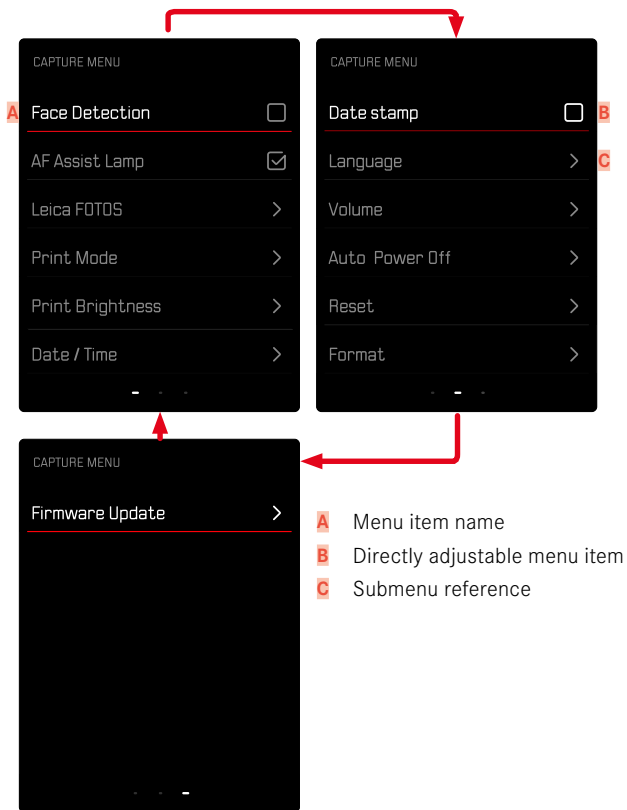

SUBMENU

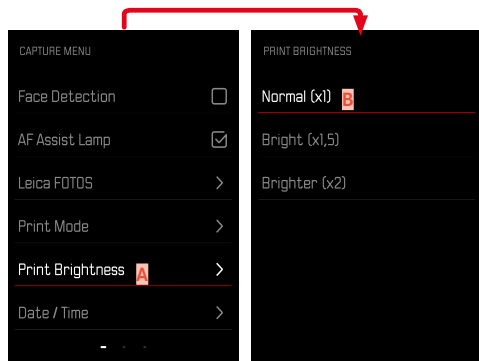

A Current menu item

B Submenu item

MENU NAVIGATION

SHOW SUBMENU

- ▶ Press the **MENU/OK** button
- ▶ Press the directional pad to the right

CONFIRM SELECTION

- ▶ Press the **MENU/OK** button
 - The screen image changes back to the active menu item.

Note

- No confirmation is needed for the selection of **On** or **Off**. An automatic save is done.

GO BACK ONE STEP

(Return to the superordinate menu item)

- ▶ Press the **BACK** button or the directional pad left
 - This option is only available for list-type submenus.

EXITING THE MENU

You can exit the menus and submenus at any time – with/without applying the settings selected there.

Go to shooting mode

- ▶ Press the **BACK** button or tap the shutter button

Go to review mode

- ▶ Press the **PLAY** button



CAMERA BASIC SETTINGS

The two menu items **Language** and **Date / Time** appear automatically when switching the camera on for the first time, after a reset to factory settings (see p. 68), or after a firmware update.

MENU LANGUAGE

Factory setting: English

Available menu languages: German, French, Italian, Spanish, Portuguese, Russian, Japanese, Traditional or Simplified Chinese, Korean

- ▶ Select **Language** in the capture menu
- ▶ Select your language
 - Aside from a few exceptions, the language will be changed for all information.

TIME/DATE

You can choose one of 6 options for the display sequence.

- ▶ Select **Date / Time** in the capture menu
- ▶ Select the desired date and time format
(**Year / Month / Day / 12 h**, **Year / Month / Day / 24 h**, **Day / Month / Year / 12 h**, **Day / Month / Year / 24 h**, **Month / Day / Year / 12 Std.**, **Month / Day / Year / 24 Std.**)
- ▶ Set the date and time



POWER SAVE MODE (STANDBY MODE)

The camera will switch to the power-saving standby mode after a preset time to extend battery life if this function is activated.

The device has two power save levels.

- Standby mode is activated after 2 min/5 min
- Automatic LCD panel shutdown (see p. 39)

Factory setting: 2 min

- ▶ Select **Auto Power Off** in the capture menu
- ▶ Select the desired setting
(5 min, 2 min, Off)

Note

- The camera can be woken from standby mode at any time by switching the main switch off and on again.

ACOUSTIC SIGNALS

Some functions can be acknowledged with acoustic signals. The following special functions can be configured separately:

- Electronic shutter sound
- AF confirmation

OPERATION SOUND

The volume of active signals can be set.

Factory setting: 2

- ▶ Select **Volume** in the capture menu
- ▶ Select **Operation Sound**
- ▶ Select the desired sound level
(Off, 1, 2, 3)

ELECTRONIC SHUTTER SOUND

Factory setting: 2

- ▶ Select **Volume** in the capture menu
- ▶ Select **Shutter Sound**
- ▶ Select the desired sound level
(Off, 1, 2, 3)

START UP SOUND

Factory setting: 2

- ▶ Select **Volume** in the capture menu
- ▶ Select **Start Up Sound**
- ▶ Select the desired sound level
(Off, 1, 2, 3)



SILENT PHOTOGRAPHY

When pictures should be taken as quietly as possible.

- ▶ Select **Volume** in the capture menu
- ▶ Select **Operation Sound/Shutter Sound/Start Up Sound**
- ▶ Select **Off** for each of these menu items





STILL IMAGE SETTINGS

One of the many advantages of digital photography is that it is very easy to change essential image properties. The Leica Sofort 2 offers several functions to customize your shots to your own preferences.

FILM EFFECT

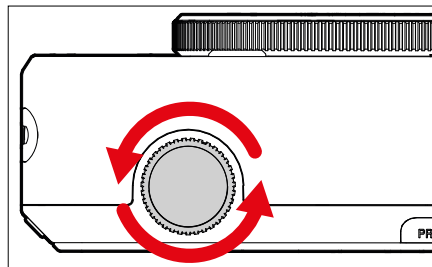

- ▶ Turn the “film effect” dial in shooting mode
 - The relevant menu appears.

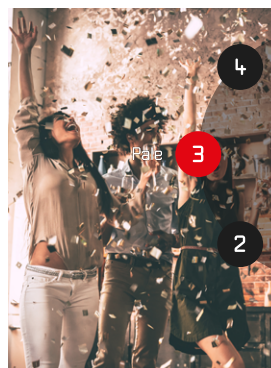

- 1 Normal
- 2 Vivid
- 3 Pale
- 4 Canvas
- 5 Monochrome
- 6 Sepia
- 7 Yellow
- 8 Red
- 9 Blue
- 10 Retro

OPTICAL EFFECT

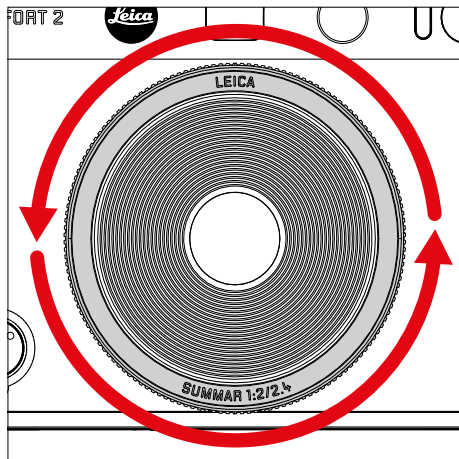

- ▶ Turn the “optical effect” dial in shooting mode
 - The relevant menu appears.

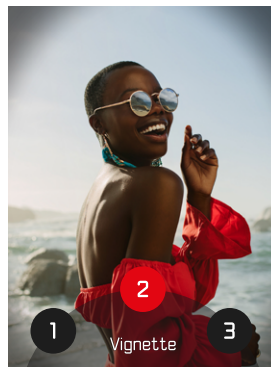

- 1 Normal
- 2 Vignette
- 3 Soft Focus
- 4 Blur
- 5 Fisheye
- 6 Color Shift
- 7 Light Leak
- 8 Mirror
- 9 Double Exposure
- 10 Half-Frame



SAVE EFFECTS COMBINATION

A combination of preferred effects can be saved in up to three favorites. This allows the effect combinations to be called up directly.

- ▶ Turn the “optical effect” dial in shooting mode
 - The relevant menu appears.
- ▶ Turn the dial to set the desired “optical effect”
- ▶ Turn the “film effect” dial
 - The relevant menu appears.
- ▶ Turn the dial to set the desired “film effect”
- ▶ Press the **FN** button

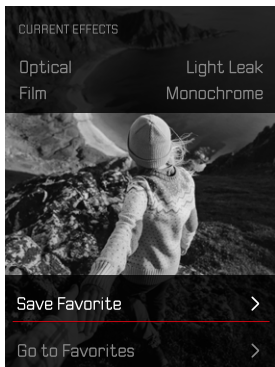

- ▶ Select **Save Favorite**
- ▶ Select a memory slot
- ▶ Press the **OK** button
 - The combination will now be saved.

DATE STAMP

This function can be used to save the date a photo was taken.



- ▶ Select **Date Stamp** in the capture menu
- ▶ Press the **OK** button to activate or deactivate the function
 - The stamp will be visible on the printed and saved images.

DATA MANAGEMENT

FORMATTING A MEMORY CARD

Memory cards that have already been in use with this camera will usually not require formatting. An unformatted memory card that is inserted into the camera for the first time must be formatted. We recommend formatting memory cards from time to time, because residual data traces (data pertaining to individual shots) may reduce the card's memory capacity.

- ▶ Select **Format** in the capture menu
- ▶ Confirm the selection
 - The status LED will flash during the process.

Notes

- Never switch off the camera while data transfer is in progress.
- All data stored on the memory card will be lost during formatting. Formatting will not be prevented by a deletion protection set for individual shots.
- All images should therefore be regularly transferred to a safe mass storage medium, e.g. the hard disk of a computer.
- A simple formatting process will initially not irretrievably destroy existing data on the card. Only the directory will be deleted, which means the data will no longer be directly accessible. Data access can be restored with appropriate software. Only data that is overwritten when new data is saved will actually be irretrievable.
- A memory card should be formatted again in the camera if it was formatted in another device, e.g. a computer.
- Contact your retailer or Leica Customer Care for assistance if the memory card cannot be formatted/overwritten (see p. 86).





DATA TRANSFER

Data can be conveniently transferred to mobile devices via Leica FOTOS. Alternatively, a card reader or USB cable can be used for the transfer.

ABOUT LEICA FOTOS

- ▶ See chapter “Leica FOTOS” (p. 72)

Notes

- We recommend using a card reader for the transfer of large files.
- The USB connection must not be interrupted while data is being transferred, as the computer or the camera could otherwise “crash” and irreparable damage could occur on the memory card.
- The camera must not be turned off or automatically shut itself down due to a lack of battery power while data is being transferred, as this can cause the computer to crash. For the same reason, the battery must never be removed from the camera while the connection is active.





PHOTOGRAPHY

FOCUSING

Your Leica Sofort 2 allows automatic focusing. Various tools are available for AF photography.

AF PHOTOGRAPHY

- ▶ Tap and hold the shutter button
 - The measurement is taken.
 - Metering was successful: the AF frame lights up green
 - Metering was unsuccessful: the AF frame lights up red
- ▶ Shutter release

DIGITAL ZOOM

Several other cropped section sizes are available in addition to the Leica Summar 2.4 f/2 image sections.

The image section that will be visible in the print appears on the monitor.

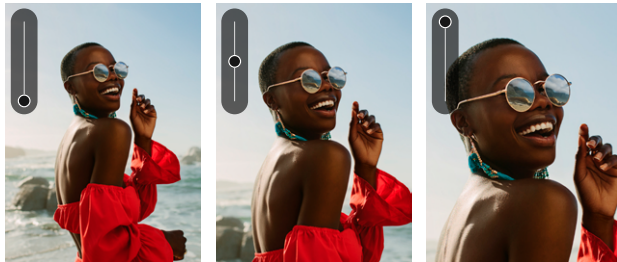

PERMANENT SETTING

- ▶ Press the directional pad up
 - Magnification scale  will be displayed.

Changing zoom levels (10 levels)

- ▶ Press the directional pad up/down

Note

- The setting remains active until the camera is switched off and on again or the zoom level is adjusted using the directional pad.

FACE DETECTION

In this metering method, the Leica Sofort 2 automatically detects faces in the image field. The focus is set automatically on the faces closest to the camera. Field metering is used if no faces are detected.

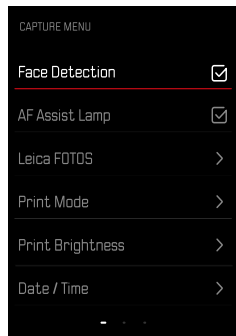

- ▶ Select **Face Detection** in the capture menu
- ▶ Press the **OK** button to activate or deactivate the function

AF ASSIST LAMP

The integrated AF assist lamp allows operation of the AF system in unfavorable lighting conditions. This lamp comes on while metering is performed, provided the function is activated.

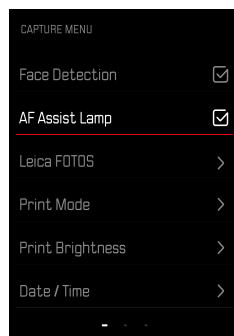

- ▶ Select **AF Assist Lamp** in the capture menu
- ▶ Press the **OK** button to activate or deactivate the function

ACOUSTIC AF CONFIRMATION

You can set an acoustic confirmation signal for successful focusing. Please read the section “Acoustic Signals” (see p. 39) for details.



MACRO FUNCTION

The working range for the focus setting can be switched quickly and easily from the standard focus range (30 cm to infinity) to the macro range (17 cm to 30 cm) using the macro function.

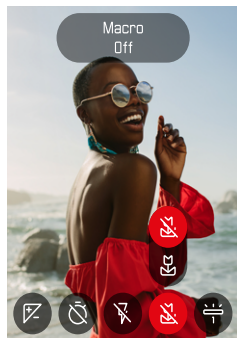

- ▶ Select **Macro** in the icon menu (see p. 33)
- ▶ Select **On** or **Off**.

WHITE BALANCE

In digital photography, White Balance ensures neutral color rendering in any light. White Balance relies on the setting made in the camera, which light color is to be rendered as 'white'.

Two methods are available:

- automatic control
- fixed presets



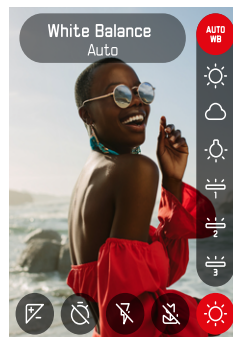

Factory setting: **Auto**



- ▶ Select **White Balance** in the icon menu
- ▶ Select the desired setting

AUTOMATIC CONTROL/FIXED SETTINGS

- **Auto**: for automatic control, which delivers neutral results in most situations
- Various fixed presets for most frequently encountered light sources:

 Auto	Automatic control
 Daylight	For outdoor shootings in sunlight
 Cloudy	For outdoor shootings in cloudy conditions
 Tungsten	For indoor shootings with (predominantly) incandescent lamp light
 Fluorescent 1	For indoor shootings with (predominantly) fluorescent lamp light 3 options are available.

EXPOSURE

EXPOSURE COMPENSATION

Exposure meters are calibrated for a medium gray scale value, which matches a standard, i.e. average image object. Should the measured image detail not fulfill that requirement, then the relevant exposure compensation can be effected.

Unlike with exposure lock, the setting remains active until it is reset.

Exposure compensation values can be set in the range ± 2 EV in $1/3$ EV increments (EV: Exposure Value).

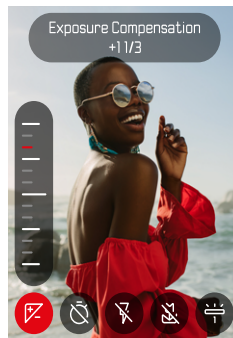



- ▶ Select **Exposure Compensation** in the icon menu
- ▶ Set the value on the scale
 - The set value is displayed above the scale.

Notes

- While setting the value, you can see the effect on the screen image, which becomes darker or lighter.
- The following applies for set compensation values, no matter how they were initially set: They remain effective until they are manually reset to 0, even if the camera is switched off and on again in the meantime.

SHOOTING MODES

SELF-TIMER

The self-timer function allows shoot with a preset time delay. We recommend that the camera is placed on a tripod.

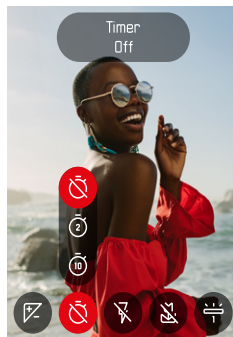

- ▶ Select **Self-timer** in the icon menu
- ▶ Select **Self-timer 2 s**/**Self-timer 10 s**
- ▶ Shutter release
 - The remaining time until exposure is counted down on the LCD panel. The self-timer LED at the front of the camera counts down the delay time.
 - The self-timer delay time can be canceled at any time by tapping the **BACK** button; the relevant settings remain intact.

FLASH PHOTOGRAPHY



PHOTOGRAPHY WITHOUT FLASH (FLASH SUPPRESSION)

The flash function can be suppressed if flash photography is forbidden or unnecessary.

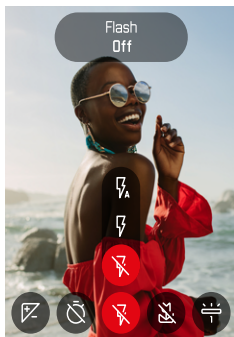

- ▶ Select **Flash** in the icon menu
- ▶ Select **Off**

To deactivate flash suppression

- ▶ Select **Flash** in the icon menu
- ▶ Select **Auto** or **On**

Note

- We recommend using a tripod if it is dark.



PRINTING

Your Leica Sofort 2 makes it possible to print out the most beautiful images as instant photos.

- ▶ Press the **PLAY** button
- ▶ Select the desired image using the directional pad
- ▶ Turn the print lever

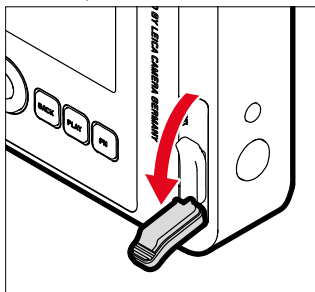

- ▶ Wait while the instant photograph is ejected
- ▶ Grab the instant photograph on one corner and pull it out completely, once it is ejected fully (the camera falls silent)
- ▶ Wait while the instant photograph develops
 - Development time is around 90 seconds depending on ambient temperature.

The picture counter counts down from “10” after each exposure and the film pack is exhausted, once the counter reaches “0”. The film pack needs to be replaced when the picture counter displays “0” (see p. 26).

Note

- Make sure that you don't accidentally cover the flash, flash sensor, exposure sensor, the lens or the film ejection slot with your finger or the carry strap.

PRINT MODE

Two different color profiles are available for the print of image. A natural variant and a more intense one. Depending on the shooting situation, the color reproduction of the prints can be selected.

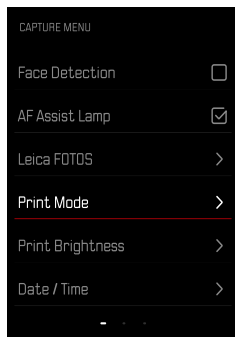

- ▶ Select **Print Mode** in the capture menu
- ▶ Select the desired setting
(**Natural** / **Rich**)

PRINT BRIGHTNESS

3 brightness levels are available for printing, in order to be able to partially correct the brightness of the prints.

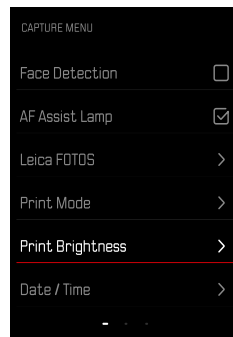

- ▶ Select **Print Brightness** in the capture menu
- ▶ Select the desired brightness level
(**Normal (x1)** / **Bright (x1.5)** / **Brighter (x2)**)





REVIEW MODE

There are two completely independent review functions available:

- short-term rendering directly after exposure
- normal review mode, in which the stored images can be viewed and managed for any length of time

Notes

- Recorded images are not automatically rotated in review mode to utilize the full screen area.
- It may not be possible to render files with this camera that were not recorded with this device.
- In some cases, the screen image may not have the expected quality, or the LCD panel will remain blank and only display the file name.
- You can toggle back from review mode to shooting mode at any time by tapping the shutter button.

CONTROL ELEMENTS IN REVIEW MODE

CONTROL ELEMENTS ON THE CAMERA

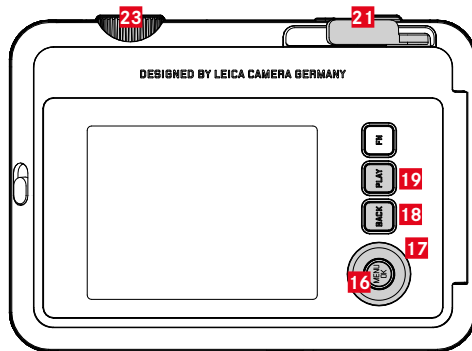

- | | |
|---------------------------|------------------------------|
| 16 Directional pad | 19 PLAY button |
| 17 MENU/OK button | 21 Print lever |
| 18 BACK button | 23 “Film effekt” dial |

DIRECT ACCESS IN REVIEW MODE

The function buttons can have individual assignments in review mode as well.

In factory settings, the function buttons have the following assignments:

Button	Function
“Film effekt” dial	Magnification
MENU/OK button	Delete
BACK button	Toggle Info Levels

The descriptions in the next few sections presume factory settings.

Note

- The assigned function is independent of the current display mode; the delete functions overview can therefore be accessed directly in full screen display mode.

STARTING/EXITING REVIEW MODE



- ▶ Press the **PLAY** button
 - The last captured image appears on the screen.
 - The following message appears if the inserted memory card does not contain any picture data: **No image in gallery.**
 - The **PLAY** button function differs, depending on the current camera setting

Initial situation	After pressing the PLAY button
Full screen display of an image	Shooting mode
Display of an enlarged cropped section/or several thumbnails	Full screen display of the image

SELECTING/SCROLLING THROUGH IMAGES

The images are visually arranged in a horizontal reel. The sorting will be strictly chronological. When the end of an image series is reached, the display automatically jumps back to the first image in the series. All images can therefore be reached by scrolling either right or left.

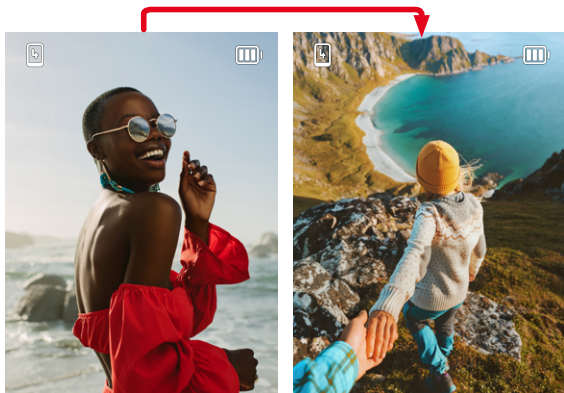

- ▶ Press the directional pad up/down

INFO DISPLAYS IN REVIEW MODE

In factory settings, images are displayed without the information for unimpeded viewing.

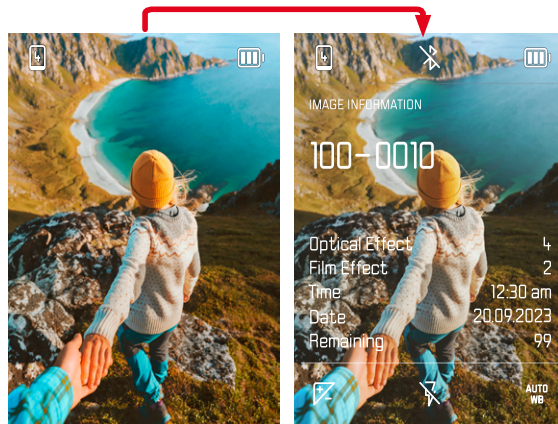

- ▶ Press the **BACK** button
 - The information is displayed.

CROPPED SECTION ZOOM

You can zoom in to any section of an image for closer inspection. Magnification in eight steps using the “film effect” dial



- ▶ Press the directional pad to move the enlarged section anywhere in the image

Note

- It may not be possible to enlarge images taken with other camera types.

DISPLAYING MULTIPLE IMAGES AT ONCE

The camera offers an overview function in which several thumbnail images can be viewed on one screen, which makes it easier to find a specific image. You can choose 4 or 9 images per overview.

OVERVIEW

- ▶ Turn the “film effect” dial to the left
 - 4 thumbnails are shown at the same time. Another turn on the dial increases the number of displayed thumbnails to 9.

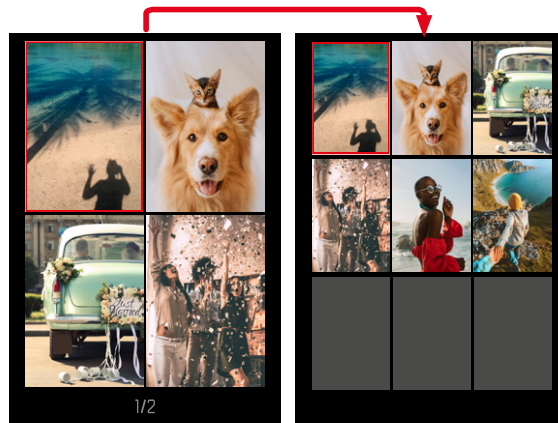

The currently viewed image is framed in red and can be selected for a closer look.

Navigating between images

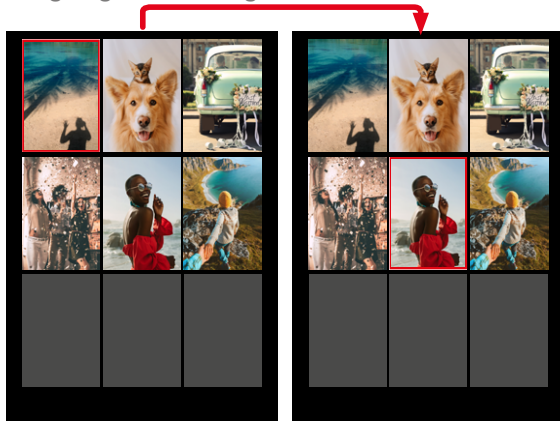

- ▶ Press the directional pad in the relevant direction

Displaying the image in full size

- ▶ Press the **BACK** button
- or
- ▶ Press the **PLAY** button

DELETING IMAGES

There are several methods available to delete images:

- deleting individual images
- deleting all images

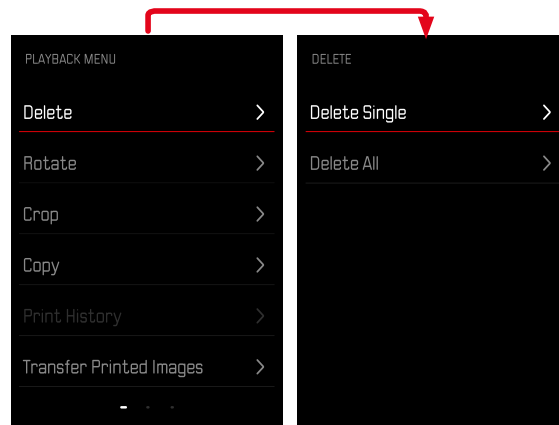

Important

- Once deleted, images are no longer retrievable.

DELETING INDIVIDUAL IMAGES

- ▶ Press the **PLAY** button
- ▶ Press the **MENU/OK** button
- ▶ Press the directional pad to the right
- ▶ Select **Delete Single**
- ▶ Press the directional pad to the right
 - The Delete screen appears.

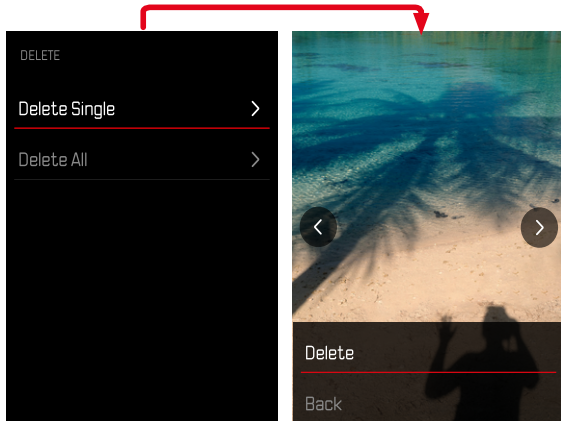

- ▶ Select **Delete**

Confirming the deletion

- ▶ Press the **MENU/OK** button
 - The picture will be deleted without additional confirmation prompt.
 - The next image will be displayed once deletion is complete. The following message appears if no other recordings are saved on the card: **No image in gallery.**

Cancelling a deletion and returning to normal review mode

- ▶ Select **Back**





DELETING ALL IMAGES

- ▶ Press the **PLAY** button
- ▶ Press the **MENU/OK** button
- ▶ Select **Delete All** in the play menu
 - The prompt **Do you really want to delete all files?** appears.

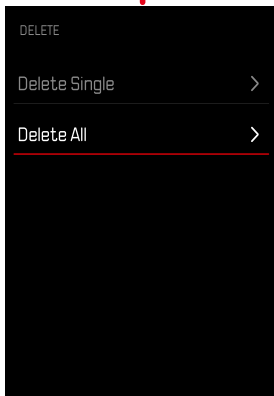

- ▶ Select **Delete**
 - The files will be deleted without additional confirmation prompt.

Note

- The message **No valid picture to play.** appears after successful deletion. The same image is displayed again if deletion was unsuccessful. When deleting several or all images, a notification screen may appear for the time needed to process the data.

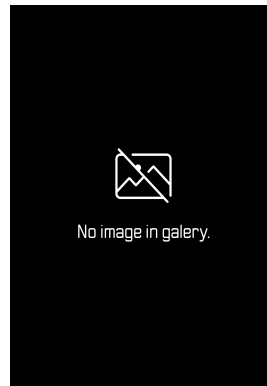

ROTATING IMAGE

- ▶ Press the **PLAY** button
- ▶ Press the **MENU/OK** button
- ▶ Select **Rotate** in the play menu
- ▶ Select **Rotate Selected Image** or **Choose Other Image**

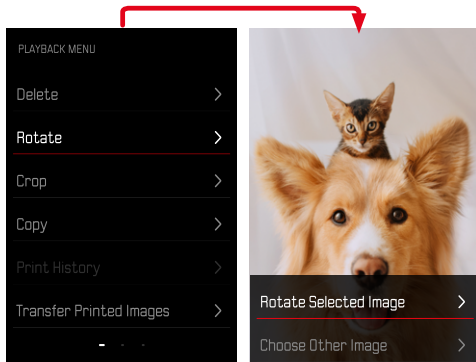

- ▶ Select **Rotate**
- ▶ Press the directional pad in the relevant direction

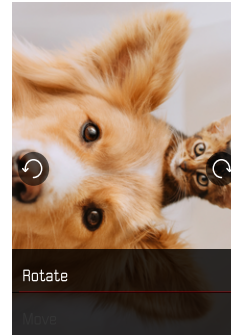



MOVING IMAGE SECTION

- ▶ Press the **PLAY** button
- ▶ Press the **MENU/OK** button
- ▶ Select **Rotate** in the play menu
- ▶ Select **Rotate Selected Image** or **Choose Other Image**

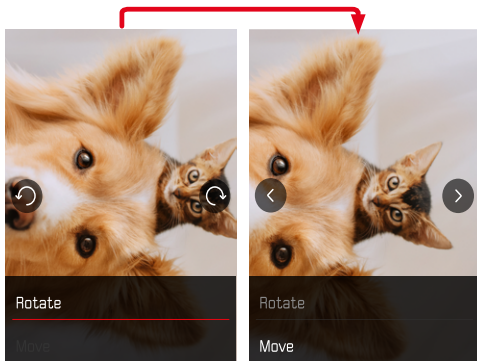

- ▶ Select **Move**
- ▶ Press the directional pad in the relevant direction

Exiting the play menu

- ▶ Press the **BACK** button or **PLAY** button

CROPPING IMAGE SECTION

- ▶ Press the **PLAY** button
- ▶ Press the **MENU/OK** button
- ▶ Select **Crop** in the play menu
- ▶ Select **Rotate Selected Image** or **Choose Other Image**

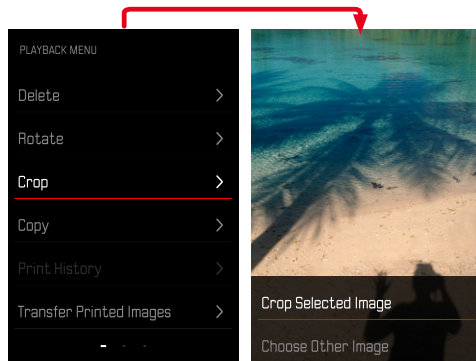

Zooming the cropped section

- ▶ Turn the “film effect” dial to the left

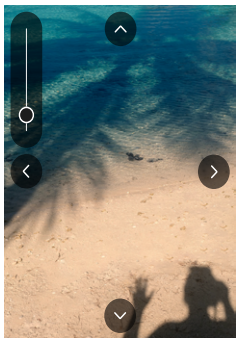

Moving the cropped section

- ▶ Press the directional pad in the relevant direction

Saving the desired cropped section

- ▶ Press the **MENU/OK** button

COPYING IMAGES

- ▶ Press the **PLAY** button
- ▶ Press the **MENU/OK** button
- ▶ Select **Copy** in the play menu
- ▶ Select the desired menu item

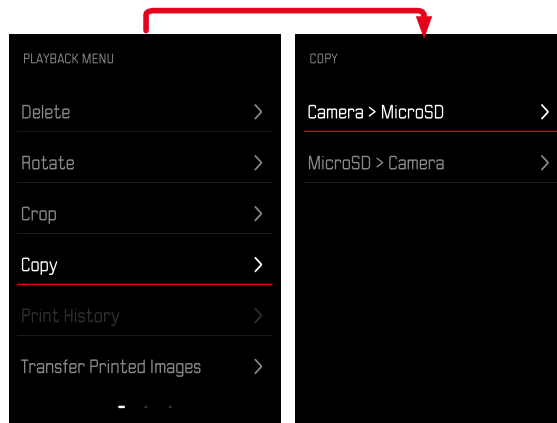

- ▶ Select **Copy Single** or **Copy All**
- ▶ Select **Copy**



DELETING PRINTED IMAGES

- ▶ Press the **PLAY** button
- ▶ Press the **MENU/OK** button
- ▶ Select **Print History** in the play menu
- ▶ Select **Delete**

Selecting the image

- ▶ Press the directional pad to the left or right

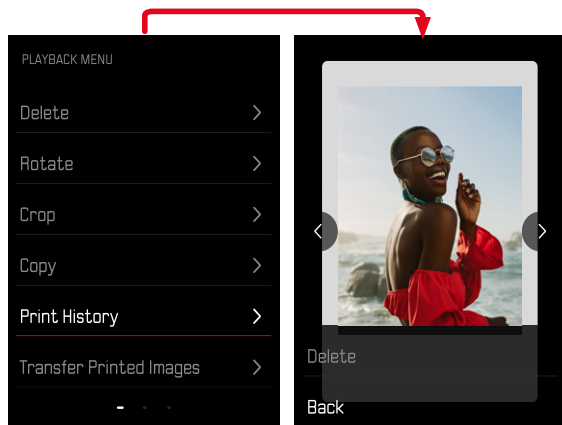

TRANSFERING PRINTED IMAGES

Images that have already been printed can be transferred to your mobile device via Leica FOTOS app. This will require an installation of the Leica FOTOS app on the mobile device. See chapter "Leica FOTOS".

- ▶ Press the **PLAY** button
- ▶ Press the **MENU/OK** button
- ▶ Select **Transfer Printed Images** in the play menu
 - An overview of the printed images displayed.

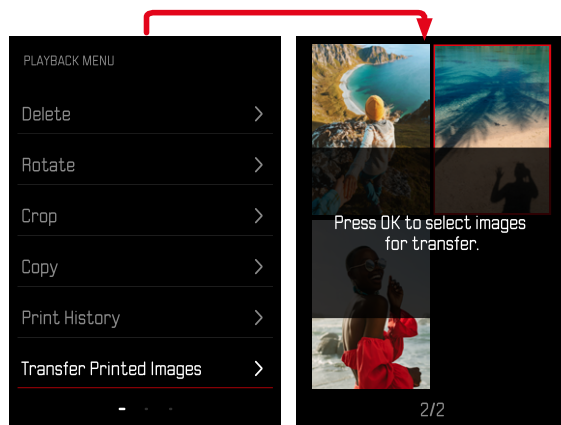

Cancelling a deletion and returning to normal review mode

- ▶ Select **Back**
- or
- ▶ Press the **PLAY** button

Selecting the image

- ▶ Press the **MENU/OK** button

Selecting a other images

- ▶ Press the directional pad in the relevant direction

Starting the transfer

- ▶ Press the **FN** button
 - The corresponding message appears.

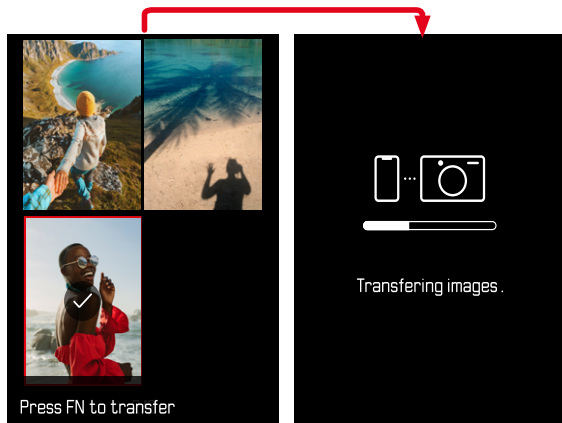



OTHER FUNCTIONS

The settings described in this chapter apply for photo and video mode alike. They are therefore available in the picture and video menu (see chapter “Camera Operation” under “Menu Control”). A setting selected in one of the modes will also apply to the other.

RESETTING THE CAMERA TO FACTORY SETTINGS

This function allows you to reset all your custom menu settings back to the factory settings. You can optionally exclude the user profiles, Wi-Fi and Bluetooth settings, as well as the image numbering from the reset individually.

- ▶ Select **Reset** in the capture menu
 - The prompt **Do you want to reset the camera settings?** appears.
- ▶ Confirm **(Confirm)** or reject **(Back)** restoring the default settings
 - Selecting **Back** will cancel the reset and the display will return to the capture menu.
- ▶ Switch the camera off and on again

FIRMWARE UPDATES

Leica is continuously working on the further improvement and optimization of your camera. Since many camera functions are entirely controlled by software, some of these improvements and additions to the functional scope can be installed in retrospect. Leica offers firmware updates at irregular intervals, which you can download from our website.

Leica will notify you of any new updates, once you have registered your camera. Users of Leica FOTOS will also be automatically notified about firmware updates for their Leica cameras.

There are two options for installing firmware updates.

- conveniently via the Leica FOTOS app (see p. 72)
- directly via the camera menu

Finding the currently installed firmware version

- ▶ Select **Firmware Update** in the capture menu
 - The current firmware version is displayed in the submenu.

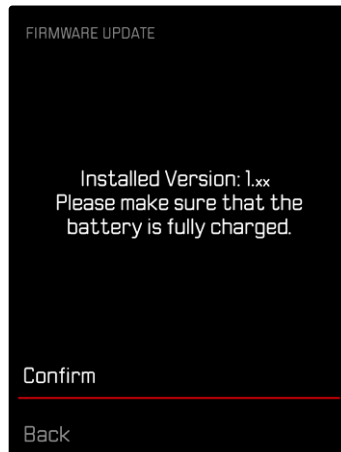

More information about registering, firmware updates and how to download them to your camera, as well as any amendments and additions to this manual can be found in the customer area of our website at:

<https://club.leica-camera.com>



EXECUTING A FIRMWARE UPDATE

Any interruption of a running firmware update may cause serious and irreparable damage to your equipment!

You will therefore have to take particular note of the following, when carrying out a firmware update:

- Do not switch off the camera!
- Do not remove the memory card!
- Do not remove the rechargeable battery!

Note

- A warning message will appear if the battery is insufficiently charged. Recharge the battery and then repeat the process described above.

PREPARATION

- ▶ Fully charge and insert the rechargeable battery
- ▶ Any stored firmware files on the memory card must be removed
 - We recommend saving any images on the memory card and reformatting it before the update.
(Caution: Loss of data! All data stored on the memory card will be lost during formatting.)
- ▶ Download the latest firmware version
- ▶ Save the download to the memory card
 - The firmware file must be stored in the main directory of the memory card (not in a sub-directory).
- ▶ Insert the memory card into the camera
- ▶ Switch the camera on



UPDATING THE CAMERA FIRMWARE

- ▶ Preparation
- ▶ Select **Firmware Update** in the capture menu
- ▶ Select **Confirm**
 - A prompt with information about the camera is displayed.
 - The update will start automatically.
 - The status LED will flash during this process.
 - Once the process has completed successfully, a relevant on-screen message and prompt to restart the device will appear on screen.
- ▶ Switch the camera off and on again

Notes

- Date & time, as well as the preferred language will have to be set up again after the restart. Relevant prompts will appear on screen.
- These settings will be applied automatically if the update is loaded via Leica FOTOS.



LEICA FOTOS

The camera can be controlled remotely using a smartphone/tablet PC. This will require an installation of the Leica FOTOS app on the mobile device. Leica FOTOS furthermore offers a variety of other useful functions:

- Geotagging for images
- File transfer
- Downloading firmware updates
- Self-timer delay time selection via remote control, e.g. for group photographs

A list of available functions and instructions for their use can be found in the Leica FOTOS app. Please read the legal notes on page 6.

- ▶ Scan the following QR code with the mobile device



or

- ▶ The app is available from Apple App Store™/Google Play Store™

CONNECTION

FIRST-TIME CONNECTION TO A MOBILE DEVICE

A pairing of the camera and the mobile device is required for a first-time connection to a mobile device.

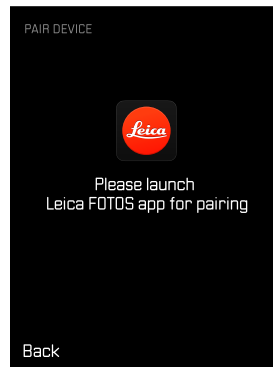
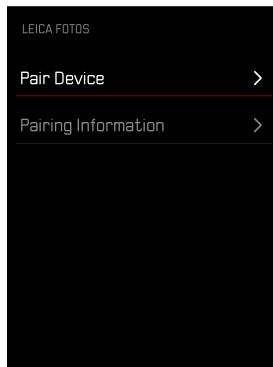



IN THE CAMERA

- ▶ Select **Leica FOTOS** in the capture menu
- ▶ Select **Pair Device**
- ▶ Wait until the QR code appears on the LCD panel

ON THE MOBILE DEVICE

- ▶ Launch the Leica FOTOS app
- ▶ Select “Add Camera”
- ▶ Select the camera model
- ▶ Select “Scan the QR code”
- ▶ Scan the QR code
 - Connection is being established. The process may take a few seconds.
 - Once successfully connected, the Status LED will light briefly, and the camera displays a relevant message.

Notes

- The pairing process may take a few minutes to complete.
- Each mobile device only needs to be paired with the camera once. The process adds the device to the list of known devices.

SKIP FIRST PAIRING

- ▶ Press the **BACK** button

CONNECTING WITH PAIRED DEVICES

VIA BLUETOOTH

IN THE CAMERA

- ▶ Select **Leica FOTOS** in the capture menu
- ▶ Select **Pair Device**
 - The camera connects to the mobile device automatically.

ON THE MOBILE DEVICE

- ▶ Launch the Leica FOTOS app
- ▶ Select the camera model
- ▶ Confirm the prompt
 - The camera connects to the mobile device automatically.



EXECUTING A FIRMWARE UPDATE

Any interruption of a running firmware update may cause serious and irreparable damage to your equipment!

You will therefore have to take particular note of the following, when carrying out a firmware update:

- Do not switch off the camera!
- Do not remove the memory card!
- Do not remove the rechargeable battery!
- Do not detach the lens!

Leica FOTOS will notify you when firmware updates are available for your Leica cameras.

- ▶ Follow the instructions provided by the Leica FOTOS app

Notes

- A warning message will appear if the battery is insufficiently charged. Recharge the battery and then repeat the process described above.
- Alternatively, firmware updates can also be installed via the camera menu (see p. 69).



CARE/STORAGE

We recommend the following if the camera will not be used for an extended period of time:

- Switch off the camera
- Remove the memory card
- Remove the battery (after approx. 2 months the set date and time will be lost)

CAMERA HOUSING

- Keep your equipment meticulously clean, as any kind of dirt residue presents a breeding ground for micro organisms.
- Only clean the camera with a soft, dry cloth. Stubborn dirt should first be moistened with a watered-down detergent and can then be wiped away with a dry cloth.
- Wet a soft cloth with tap water, wring it out thoroughly and use it to wipe down the camera. Then wipe it down thoroughly with a dry cloth.
- Wipe the camera with a clean, lint-free cloth to remove stains and fingerprints. Tougher dirt in hard to reach corners of the camera housing can be removed with a small brush. Take care not to touch the shutter blades.
- Store the camera in a closed and padded container to prevent friction damage and protect it against dust accumulation.
- Keep the camera in a dry, sufficiently ventilated place, where it will not be subjected to high temperatures and humidity. Make sure to remove all moisture from the camera if it was used in humid conditions.
- Do not store the camera in a leather case for extended periods of time to prevent fungal contamination.

- Empty your camera bag completely if it ever gets wet during use. Your equipment might otherwise be subjected to moisture and tanning residue released by the moist leather.
- All mechanical bearings and sliding surfaces on your camera are lubricated. Remember to press the shutter button several times every three months to prevent the lubrication points hardening if the camera will not be used for an extended period of time. We also recommend repeated adjustment and use of all the other operating elements.
- When using your camera in tropical climates, make sure to expose the equipment to daylight and fresh air as much as possible to prevent fungal growth. Storage in airtight containers or cases is recommended only in conjunction with a desiccant like silica gel.

LENS

- A soft-bristle brush will usually suffice to remove dust from the outer lenses. Remove more severe soiling with a clean, soft cloth that is completely free of foreign matter. Wipe the lens in a circular motion from the center outward. We recommend using micro-fiber cloths that come in a protective container and are available from photography shops and other optical retailers. These cloths are machine-washable at 40°C. Do not use fabric softener and do not iron them. Never use spectacle lens cleaning cloths, as these are soaked in chemicals, which could damage the glass of the camera lenses.
- Attach a transparent UVA filter for optimal front lens protection in unfavorable conditions (e.g. sand, salt water spray). Please remember that the filter may create unwanted light reflections in some backlight situations and in case of high contrasts.
- Lens caps also protect the lens against accidental fingerprint smudges and rain.

- All mechanical bearings and sliding surfaces on your lens are lubricated. Make sure to periodically move the focus ring and the aperture ring to prevent seizing if the lens will not be used for an extended period of time.

LCD PANEL

- Switch off your camera and leave it to stand at room temperature for around 1 hour if condensation has formed on or in the camera. The condensation will disappear, once the camera temperature has reached room temperature.

RECHARGEABLE BATTERY

- Lithium-ion rechargeable batteries should only be stored partially charged, i.e. not fully depleted or fully charged. The camera LCD panel will show the current charge level of the battery. Charge the battery twice a year for around 15 minutes to avoid deep discharge in case of very long storage periods.

MEMORY CARDS

- Make sure to store memory cards in their anti-static container when not in use.
- Do not store memory cards where they will be exposed to high temperatures, direct sunlight, magnetic fields or static electricity. Always remove the memory card if the camera will not be used for an extended period of time.
- We recommend formatting memory cards from time to time, as fragmented residual data from deleted files may block some of the storage capacity.

Problem	Possible causes to check	Troubleshooting suggestions
Battery issues		
Battery is depleted too quickly	Battery too cold	Warm the battery (e.g. in pants pocket) and only insert directly before use
	Battery too hot	Allow battery to cool down
	LCD panel or EVF set too bright	Reduce brightness
	Permanent WLAN connection	Deactivate WLAN when not in use
	Battery has been recharged too many times	The battery has reached the end of its operating time Replace battery
Camera problems		
The camera suddenly switches itself off	Battery is depleted	Charging the battery
The camera won't switch on	Battery is depleted	Charging the battery
	Battery too cold	Warming the battery
The camera switches off again immediately after it is switched on	Battery is depleted	Charging the battery
Camera does not recognize the memory card	The memory card is not compatible or defective	Replace the memory card
	Memory card is incorrectly formatted	Format the memory card in the camera (Caution: Loss of data!)
Menus and displays		
Display language is not English	-	Select English in the Language menu
	Viewing angle is too small	View the LCD panel at a perpendicular angle
The number of remaining shots does not count down after shooting	The image requires only very little memory space	This is not a fault; the number of remaining shots is calculated as approximations
Shooting		
Image noise appears on the LCD panel/in the viewfinder when the shutter button is pressed to the first pressure point	The gain is increased to aid image composition if the object is insufficiently lit with reduced lens aperture	Not a fault - image quality will not be impacted
LCD panel/viewfinder deactivates after a very short time	Power Save settings are activated	Change the settings as needed
The display switches off after shooting/the LCD panel goes dark after shooting	Flash loads after shooting, LCD panel deactivates during load time	Wait until the flash is charged

Flash won't fire	The flash cannot be used with the current settings	Refer to the list of flash function-compatible settings
	Battery is depleted	Charge or replace the battery
	Pressing the shutter button while flash is still loading	Wait until the flash is loaded
	Image effect active	Change the setting
The flash does not fully illuminate the object	Object is outside the flash range	Move object into flash range
	Flash is covered	Make sure the flash unit is not covered by your finger or some object
The camera won't release/shutter button is deactivated/shooting not possible	Memory card is full	Replace the memory card
	The memory card is not formatted	Reformat the memory card (Caution: Loss of data!)
	The memory card is write protected	Deactivate the write protection on the memory card (small lever on the side of the memory card)
	Dirt on the memory card contacts	Clean the contacts with a soft cotton or linen cloth
	The memory card is damaged	Replace the memory card
	The camera has switched off automatically (Auto Power Off)	Switch the camera on again deactivate auto shutdown as needed
	Image data is being written to the memory card and the cache is full	Wait
	Battery is depleted	Charge or replace the battery
	Camera is processing a image	Wait
No face detection/faces are not recognized	Face is covered (sunglasses, hat, long hair, etc.)	Remove distracting objects
	Face takes up to little space in the picture composition	Change image composition
	Face is tilted or horizontal	Keep face straight
	Camera not held straight	Hold camera straight
	Face is insufficiently lit	Use flash, improve illumination
	The incorrectly selected object is a face	Deactivate face detection
The image on the LCD panel displays lots of noise	Light enhancement function of the LCD panel in dark surroundings	Not a fault – image quality will not be impacted
Image storage takes a long time	Noise reduction is activated for long-term exposures	Deactivate the function
	The memory card inserted is slow	Use a suitable memory card
Review and photo management		
The time and date settings are incorrect or are not displayed	The camera has not been in use for an extended period of time (the battery was removed)	Insert a charged battery and configure the correct settings



The time and date stamp on images are incorrect	Time settings are incorrect	Set the time correctly Caution: Time settings will be lost if the camera is not used/remains in storage with a depleted battery over an extended period of time
The time and date stamp on images are unwanted	Setting was ignored	Cannot be removed in retrospect Deactivate the function as needed
Images are damaged or missing	The memory card was removed while the readiness indicator was flashing	Never remove the memory card while the readiness indicator is flashing. Charge the battery.
	The memory card formatting is faulty or the card is damaged	Reformat the memory card (Caution: Loss of data!)
Image quality		
The image is too bright	Light sensor was covered during shooting	Make sure that the light sensor is not obstructed
Unnatural colors	White balance not or incorrectly set	Adjust white balance to light source or adjust manually
Round white stains, similar to soap bubbles	Flash photography in a very dark environment: reflections of dust particles	Deactivate the flash
Images are out of focus	Lens is dirty	Clean the lens
	Lens is obstructed	Make sure that lens is unobstructed
	Camera moved during shooting	Use flash Mount the camera on a tripod
Images are overexposed	Flash is activated in bright surroundings	Change the flash mode
	Strong light source in the image	Avoid strong light sources in the image
	(Half) backlight falling into the lens (also from light sources outside the image range)	Use the lens hood or change to another object
Out of focus/picture stabilizer not functioning	Shooting at a dark location without flash	Use a tripod
Horizontal stripes	Picture was taken with electronic shutter under a light source like a fluorescent lamp	Try shorter shutter speeds
Unnatural colors and brightness	Shooting in artificial light or extreme brightness	Set white balance or select correct lighting presets
No images are displayed	No memory card inserted	Insert a memory card
	The photos were taken with another camera	Transfer the files to another device to view them
Images cannot be displayed	File name was changed on a PC	Use suitable software for file transfers from a PC to the camera

Smartphones/WLAN		
WLAN connection gets interrupted	Camera deactivates when it overheats (safety feature)	Allow camera to cool down
Cannot pair with a mobile device	The camera was already paired with the mobile device	Delete the camera registration from the Bluetooth settings in the mobile device and repeat pairing process
Mobile device connection/image transfer not working	The mobile device is too far away	Bring the devices closer to each other
	Interference from other devices in the vicinity, e.g. other smartphones or a microwave oven	Increase distance to interfering devices
	Interference from multiple mobile devices in the vicinity	Re-establish the connection/disconnect other mobile devices
	Mobile device is currently connected to another device	Check connection
Camera does not appear on the WLAN configuration screen of the mobile device	Mobile device does not recognize camera	Switch the WLAN function of the mobile device off and on again
Print		
No image will be printed	No image is selected	Select the image for printing
	No film pack inserted	Insert a film pack
	Film pack used up	
Colors of the print are too faint	Natural is selected in menu item "print mode"	Select Rich
Error message is displayed during printing	Film cover of the film pack was not ejected correctly	Remove the film pack and adjust the tab of the film cover. Do not pull out film cover!

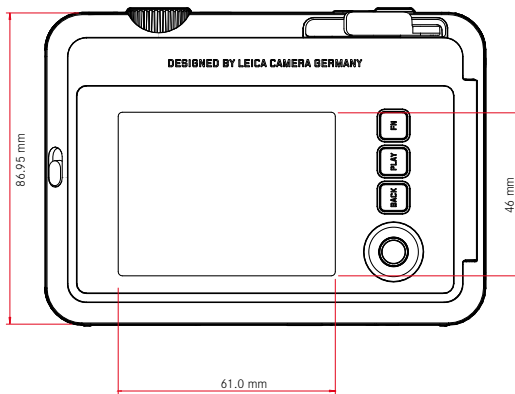
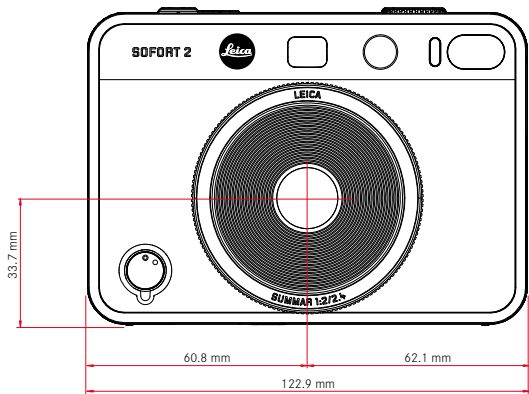
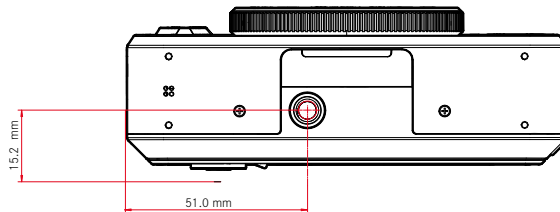
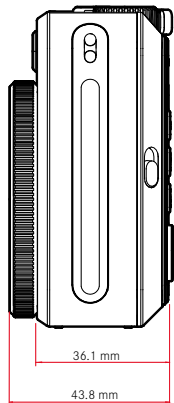

CAMERA

Designation

Leica Sofort 2

Camera type

Hybrid instant camera with print function

Type No.

8262

Order No.

White: 19188, Red: 19189, Black: 19190

Storage medium

Internal memory (approx. 45 images), microSD/microSDHC card (approx. 850 images with 1 GB microSD card)

Material

Synthetic housing: Polycarbonate frame with polymethyl methacrylate front and back cover

Operating conditions

5°C to +40°C

Interfaces

USB 3.1 Gen1 Type-C

Tripod thread

A 1/4 DIN 4503 (1/4") in the base

Weight

Approx. 320 g (with lens cap, without film pack)

SENSOR

Sensor size

CMOS-Sensor, 1/5"

Filter

RGB color filter

File formats

JPG (DCF 2.0, Exif 2.31)

Image resolution

2560x1920 pixels (4.9 MP)

File size

approx. 1.2 MB

Color space

Photo: sRGB

LENS

Designation

Leica Summar 2.4 f/2 (equivalent to approx. 28 mm format)

Aperture range

f2 to f16 (automatic exposure control)

Creative function

Normal, Vignette, Soft Focus, Blur, Fisheye, Color Shift, Light Leak, Mirror, Double Exposure, Half-Frame

PHOTO PRINTING

Printing options

Images stored in the internal memory and on the inserted memory card can optionally be printed. The last 50 prints will be saved and can be printed repeatedly. When the Leica FOTOS app is connected, images can be sent to the camera for camera output after printing.

Printing resolution

1600x600 pixels (800x600 pixels for printing via the Leica FOTOS app)

Compatible film packs

Leica instant film pack:

Sofort color film pack (mini), Warm White: 19677

Sofort color film pack (mini) Neo Gold: 19678

Sofort color film duo pack (mini), Warm White: 19679

Printing film effects

Normal, Vivid, Pale, Canvas, Monochrome, Sepia, Yellow, Red, Blue, Retro



Printing time

approx. 16 seconds

Developing time

approx. 90 seconds

Film pack size

86 x 54 mm

Image size

62 x 46 mm

LCD PANEL

3" TFT LCD, approx. 460,000 dots

SHUTTER

Shutter speeds

1/4 – 1/8000 s (automatic exposure control)

Focusing

FOCUSING

Focusing range

10 cm to ∞

Focus mode

AFs

EXPOSURE

Exposure metering

TTL 256 split metering, multimetering

Exposure modes

Program AE mode

Exposure compensation

±2 EV in 1/3 EV increments

ISO sensitivity range

ISO 100 to ISO 1600 (automatic exposure control)

White balance

AutoAutomatic (Auto), presets (Daylight, Cloudy, Tungsten, Fluorescent 1, Fluorescent 2, Fluorescent 3)

FLASH

Range

Effective range: approx. 0.5 m-1.5 m

Flash control

Automatic flash (Auto) / flash always activated (On) / flash deactivated (Off)

EQUIPMENT

Bluetooth

Bluetooth 4.2 LE: 2402–2480 MHz, maximum output (e.i.r.p.): 7.79 dBm

Menu languages

English, German, French, Italian, Spanish, Portuguese, Russian, Japanese, Traditional Chinese, Simplified Chinese, Korean

POWER SUPPLY

Internal battery

Lithium-ion battery (internal, non-removable), Made in China; 3.7V, 740 mAh, 2.6 W

Approx. 100 instant photographs (with fully charged battery)

Charging time approx. 2–3 hours with camera switched off: 5 V/500 mA (2.5 W to 5 W)

USB power supply

When in standby mode or Off: USB charging function

When On: USB power supply and intermittent charging

Scope of delivery

USB cable, carry strap, quick start guide, lens cap





LEICA CUSTOMER CARE

Please contact the Customer Care department of Leica Camera AG for the maintenance of your Leica equipment and for help and advice regarding Leica products and how to order them. You can also contact the Customer Care department or the repair service provided by your regional Leica subsidiary for repairs or warranty claims.

LEICA GERMANY

Leica Camera AG

Leica Customer Care
Am Leitz-Park 5
35578 Wetzlar
Germany

Phone: +49(0)6441 2080-189

Fax: +49(0)6441 2080-339

Email: customer.care@leica-camera.com

<https://leica-camera.com>

YOUR NATIONAL REPRESENTATIVE

You will find the Customer Care department responsible for your locality on our homepage:

<https://leica-camera.com/en-US/contact>

LEICA AKADEMIE

Have a look at our full seminar program with many interesting workshops on the topic of photography at:

<https://leica-camera.com/en-US/leica-akademie>

