



# LEICA D-LUX 5

Instructions

# Table of Contents

## Before Use

Quick Guide .....	5
Scope of Delivery .....	7
Accessories .....	7
Names of the Components .....	8

## Preparation

Removing the Hot Shoe Cover .....	11
Operating the Rear Dial .....	12
Attaching the Lens Cap .....	13
Attaching the Shoulder Strap .....	14
Charging the Battery .....	16
• Approximate operating time and number of recordable pictures .....	19
Inserting and Removing Card and Battery .....	21
About the Internal Memory/the Card .....	23
Setting Date/Time (Clock Set) .....	25
• Changing the Clock Setting .....	26
Setting the Menu .....	27
• Setting menu items .....	28
• Using the Quick Menu .....	30
About the Setup Menu .....	31

## Basic

Selecting the [REC] Mode to Record Still or Motion Pictures .....	41
• Tips for taking good pictures .....	43
• Select the Aspect Ratio .....	43
• Taking still pictures .....	44
• Recording a motion picture .....	44
Program Mode .....	45
• Focusing .....	46
• Focusing off-center subjects .....	47
• Preventing camera shake .....	47
• Direction Detection Function .....	47
• Program Shift .....	48
Snapshot Mode .....	49
• Scene Detection .....	50
• AF Tracking Function .....	51
• Settings in Snapshot Mode .....	52
Using the Zoom .....	54
• Using the Optical Zoom/ Using the Extended Optical Zoom (EZ)/Using the Intelligent Zoom/ Using the Digital Zoom .....	54
• Using the Step Zoom .....	57

Playing Back Pictures ([NORMAL PLAY]) .....	58
• Displaying Multiple Images .....	59
• Using the Playback Zoom .....	60
• Enlarge the focus point (display focus point) .....	61
• Switching the [PLAYBACK MODE] .....	61
Deleting Pictures .....	62
• Deleting a single picture .....	62
• Deleting multiple or all the pictures .....	63

## Advanced (Recording pictures)

Switching the display on the Monitor .....	64
Using the Built-in Flash .....	67
• Switching to the appropriate flash setting .....	67
Close-up Pictures .....	73
Using the Self-Timer .....	74
Setting the Sensitivity .....	75
Exposure Compensation .....	77
Using Auto Bracket/Aspect Bracket .....	78
• Auto Bracket .....	78
• Aspect Bracket .....	79
Aperture- and Shutter-Priority Modes .....	81
• Aperture-Priority Mode .....	81
• Shutter-Priority Mode .....	81
Manual Exposure Mode .....	82
Aperture Value and Shutter Speed .....	83
Manual Focusing .....	84
• MF ASSIST .....	85
Using My Color Mode .....	87
• Adjusting the custom settings to achieve desired effects .....	89
Registering Personal Menu Settings (Registering custom settings) .....	90
Using Custom Mode .....	91
Using Scene Mode .....	92
• [PORTRAIT] .....	93
• [SOFT SKIN] .....	93
• [SELF PORTRAIT] .....	94
• [SCENERY] .....	94
• [PANORAMA ASSIST] .....	95
• [SPORTS] .....	96
• [NIGHT PORTRAIT] .....	96
• [NIGHT SCENERY] .....	96
• [FOOD] .....	97
• [PARTY] .....	97
• [CANDLE LIGHT] .....	97
• [BABY1]/[BABY2] .....	98
• [PET] .....	99
• [SUNSET] .....	99
• [HIGH SENS.] .....	99
• [HI-SPEED BURST] .....	100
• [FLASH BURST] .....	101
• [STARRY SKY] .....	102
• [FIREWORKS] .....	102

• [BEACH].....	103
• [SNOW].....	103
• [AERIAL PHOTO].....	103
Recording Motion Pictures.....	104
• Changing [REC MODE] and [REC QUALITY].....	108
Recording Motion Pictures with Manual Settings.....	111
Using the Face Recognition Function.....	113
• Face Settings.....	114
• Setting Auto Registration/Sensitivity.....	117
• Auto Registration.....	118
Useful Functions at Travel Destinations.....	119
• Recording which Day of the Vacation and the Location of the Vacation.....	119
• Recording Dates/Times at Overseas Travel Destinations (World Time).....	122
Using the [REC] Mode Menu.....	124
• [FILM MODE].....	124
• [RESOLUTION].....	127
• [QUALITY].....	129
• [SENSITIVITY].....	130
• [ISO LIMIT SET].....	130
• [ISO INCREMENTS].....	130
• [WHITE BALANCE].....	131
• [FACE RECOG.].....	134
• [AF MODE].....	134
• [PRE AF].....	138
• [AF/AE LOCK].....	139
• [METERING MODE].....	140
• [i.EXPOSURE].....	140
• [MULTI EXPO.].....	141
• [MIN. SHTR SPEED].....	143
• [BURST].....	144
• [i.RESOLUTION].....	145
• [i.ZOOM].....	145
• [DIGITAL ZOOM].....	145
• [STEP ZOOM].....	146
• [STABILIZER].....	146
• [AF ASSIST LAMP].....	147
• [FLASH].....	147
• [FLASH SYNCHRO].....	148
• [FLASH ADJUST.].....	148
• [RED-EYE REMOVAL].....	149
• [MONITOR MODE].....	149
• [AUTO BRACKET].....	150
• [ASPECT BRACKET].....	150
• [CLOCK SET].....	150
Using the [MOTION PICTURE] Mode Menu.....	151
• [REC MODE].....	151
• [REC QUALITY].....	151
• [EXPOSURE MODE].....	152
• [CONTINUOUS AF].....	152
• [WIND CUT].....	152

Entering Text.....	153
--------------------	-----

## Advanced (Playback)

Playing Back Pictures in Sequence (Slide Show).....	154
Selecting Pictures and Playing them Back.....	156
• [MODE PLAY].....	156
• [CATEGORY PLAY].....	157
• [FAVORITE PLAY].....	158
Playing Back Motion Pictures.....	159
Creating Still Pictures from a Motion Picture.....	160
Using the [PLAYBACK] Mode Menu.....	161
• [CALENDAR].....	161
• [TITLE EDIT].....	162
• [VIDEO DIVIDE].....	163
• [TEXT STAMP].....	164
• [RESIZE].....	167
• Reducing the resolution.....	167
• [CROPPING].....	168
• [LEVELING].....	169
• [ROTATE DISP.].....	170
• [FAVORITE].....	171
• [PRINT SET].....	172
• [PROTECT].....	174
• [FACE REC EDIT].....	175
• [COPY].....	176

## Connecting to other equipment

Playing Back Pictures on a TV.....	177
• Playing back pictures using the AV cable (supplied).....	177
• Playing back pictures on a TV with an SD Memory Card slot.....	178
• Playing back pictures on a TV with an HDMI socket.....	178
Saving the Recorded Still Pictures and Motion Pictures.....	183
• Copying the playback image using an AV cable.....	183
Connecting to a PC.....	185
Printing the Pictures.....	189
• Selecting a single picture and printing it.....	190
• Selecting multiple pictures and printing them.....	191
• Print Settings.....	192

---

---

## Miscellaneous

---

---

Using the Electronic Viewfinder	
EVF1 .....	195
Using an external flash unit.....	197
Screen Display .....	199
Cautions for Use .....	203
Message Display .....	209
Troubleshooting .....	212
Number of Recordable Pictures and Available Recording Time .....	222
Leica Service Addresses.....	230

## Quick Guide

This is an overview of how to record and play back pictures with the camera. For each step, be sure to refer to the pages indicated in brackets.

### 1 Charge the battery. (P16)

- The battery is not charged when the camera is shipped. Charge the battery before use.

plug-in type

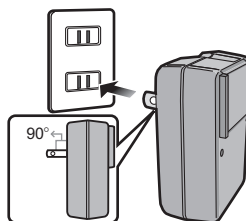

cable type

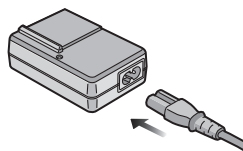

### 2 Insert the battery and the card. (P21)

- When you do not wish to use the card, you can record or play back pictures on/from the internal memory. (P23)  
Refer to P24 when you use a card.

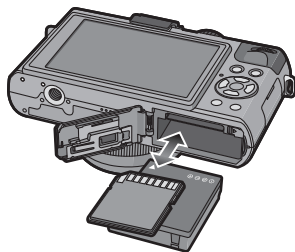

### 3 Turn the camera on to take pictures.

- 1 Set the mode dial to [P].
- 2 Press the shutter button to take pictures. (P44)

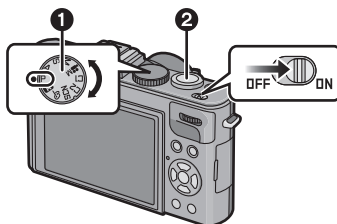

**4** Play back the pictures.

- 1 Press [▶].
- 2 Select the picture you want to view.  
(P58)

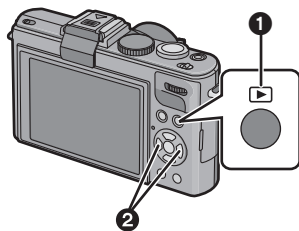

## Scope of Delivery

	Order No.
Rechargeable battery BP-DC10-E BP-DC10-U	18 719 18 720
Charger BC-DC10-E BC-DC10-U	423-092.001-010 423-092.002-010
Mains cable EU UK AUS TW CN KR	423-068.801-019 423-068.801-020 423-068.801-023 424-025.002-000 423-082.805-004 423-082.805-005 (delivery differs depending on markets)
Shoulder strap	423-092.001-014
Lens cap	423-092.001-018
Lens cap string	423-092.001-019
CD with instr. PDFs	423-092.001-016
USB cable	423-092.001-020
AV cable	423-092.001-022
Battery case	424-036.001-000
Hot shoe cover	423-092.001-015
Button template for Canada / Taiwan	423-092.001-025
Short instructions	93 357 -360 (delivery differs depending on markets)
Notice regarding registration and SW download	93 367
Warranty Card	439-399.100-026

## Accessories

	Order No.
Everready case	18 722
Leather case	18 723
Soft leather case	18 724
Hand grip D-LUX 5	18 715
Electronic Viewfinder EVF1	18 716
HDMI mini cable	14 491
LEICA CF 22 Flash unit	18 694
Mini tripod	14 320
Tabletop tripod	14 110
Ball and Socket head	14 100

### Notes:

- Cards are optional. You can record or play back pictures on the internal memory when you are not using a card.
- SD, SDHC, and SDXC memory cards are indicated as card in these instructions.
- Check that all items belonging to the scope of delivery are included before using the camera.
- The items and their shape may differ depending on the country or area where the camera was purchased.
- Please dispose of all packaging appropriately.

## Names of the Components

- 1 Lens (P204, 205)
- 2 Self-Timer indicator (P74)  
AF Assist Lamp (P147)
- 3 Flash (P67)
- 4 Shoulder strap eyelet (P14)
- 5 Focus selector switch (P45, 73, 84)

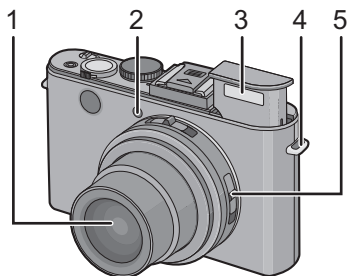

- 6 LCD monitor (P64, 199)
- 7 [AF/AE LOCK] button (P51, 136, 139)
- 8 Playback button (P58)
- 9 Status indicator (P22, 35, 41)
- 10 [MENU/SET] button (P25)
- 11 [DISPLAY] button (P64)
- 12 [Q.MENU] (P30)/Delete button (P62)

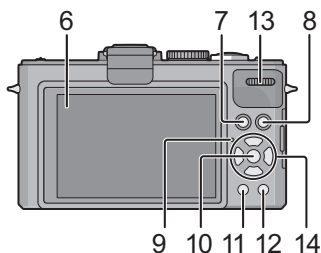

- 13 Rear dial (P48, 59, 60, 77, 81, 82, 84, 111, 137)

Rear dial operation is indicated as follows in these instructions:

e.g.: Rotate to the left or to the right



e.g.: Press



- Refer to P12 for operation of the rear dial.



## 14 Cursor buttons

▲/[FOCUS] button (P51, 61, 137)

▼/Function button (P32)

Assign Menu to ▼ button. It is convenient to register a Menu that is used often.  
 [FILM MODE]/[QUALITY]/[METERING MODE]/[WHITE BALANCE]/[AF MODE]/  
 [I.EXPOSURE]/[GUIDE LINE]/[REC AREA]/[REMAINING DISP.]/[FLASH]/  
 [AUTO BRACKET]/[ASPECT BRACKET]

◀/Self-Timer button (P74)

▶/ISO (P75)

Cursor button operation, e.g. when one of them should be pressed, is indicated as follows in these instructions:

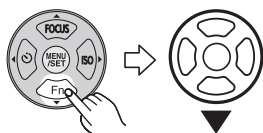

or

Press ▼

15 Aspect ratio selector switch (P43)

16 Microphone (P105)

17 Zoom lever (P54)

18 Motion picture button (P44, 104)

19 Flash open switch (P67)

20 Hot shoe cover (P11, 195, 197)

21 Mode dial (P41)

22 Shutter button (P49)

23 Camera ON/OFF switch (P25)

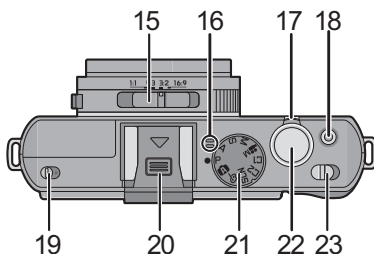

24 [HDMI] socket (P179, 181)

25 [AV OUT/DIGITAL] socket (P177, 183, 185, 189)

26 Lens ring front

27 Lens barrel

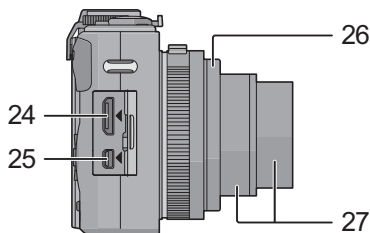

- 28 Tripod thread
- When you use a tripod, make sure the tripod is stable when the camera is attached to it.
- 29 Speaker (P159)
- Do not cover the speaker with your fingers.
- 30 Card/Battery door (P21)
- We recommend using a battery with sufficient power when recording motion pictures.
- 31 Release lever (P21)

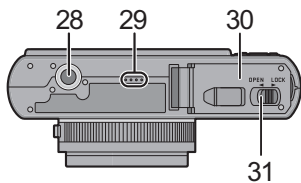

## Removing the Hot Shoe Cover

The camera comes with a hot shoe cover in place.

To use the Electronic Viewfinder EVF1 (P195) or an External Flash unit (P197) (both available as accessories, see P7), please remove the hot shoe cover.

**Press the hot shoe cover release button ① and pull the shoe cover in the direction of the arrow ②.**

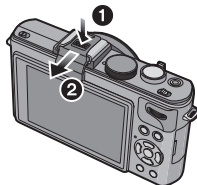

### Note

- When not using the Electronic Viewfinder EVF1 or an External Flash unit, be sure to attach the hot shoe cover.
- Please be careful not to lose the hot shoe cover.
- When not using the hot shoe cover, be careful not to let liquid, sand, or any other foreign matter enter the connection terminals.
- Keep the Hot Shoe Cover out of reach of children to prevent swallowing.

## Operating the Rear Dial

There are 2 ways to operate the rear dial, rotating left or right, and deciding by pressing.

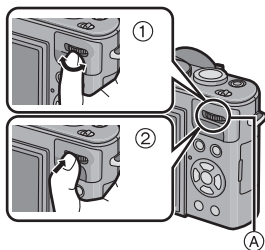

### Example of operation during recording/playback screen

	① "Rotating"	② "Pressing"
*1	Adjustments of Program Shift (P48), Manual Focus (P84), Aperture (P81), Shutter Speed (P81), etc.	Switching to compensating the exposure (P77), switching to Manual Focus operation (P84), etc.
*2	Forwarding/rewinding of pictures during 1 screen playback (P58), Multi Playback (P59), Calendar Search (P161), Playback Zoom (P60).	Picture selection during Multi Playback and Calendar Search.

Ⓐ Rear dial

\*1 Recording

\*2 Playback

#### Note

- The sound of the rear dial operation may be recorded when operated during motion picture recording.

## Attaching the Lens Cap

- When you turn the camera off or carry the camera, attach the lens cap to protect the surface of the lens.

**1** Pass the string through the lens cap eyelet.

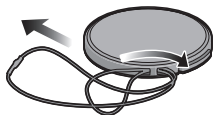

**2** Pass the same string through one of the camera strap eyelets.

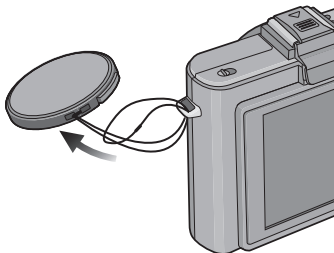

**3** Attach the lens cap.

- Detach the lens cap before turning on the camera in the Recording Mode.
- Do not hang or swing around the camera holding it only by the lens cap string.
- **Be careful not to lose the lens cap.**

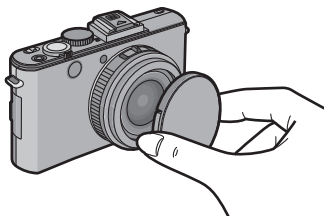

## Attaching the Shoulder Strap

- We recommend attaching the shoulder strap when using the camera to prevent it from dropping.

**1** Pass the shoulder strap through the shoulder strap eyelet on the camera body.

(A): Shoulder strap eyelet

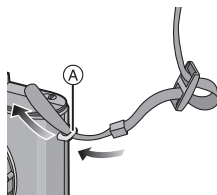

**2** Pass the end of the shoulder strap through the ring in the direction of the arrow and then pass it through the stopper.

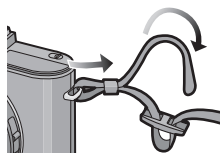

**3** Pass the end of the shoulder strap through the hole on the other side of the stopper.

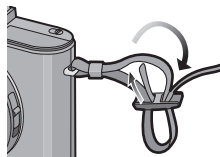

**4** Pull the other side of the shoulder strap and then check that it is secure.

- Perform steps 1 to 4 and then attach the other side of the shoulder strap.

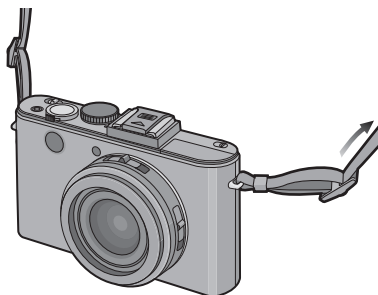

 **Note**

- Be sure to follow the steps and attach the shoulder strap correctly.
- Check that the shoulder strap is firmly attached to the camera.
- Use the shoulder strap around your shoulder.
  - Do not wrap the strap around your neck.
  - It may result in injury or accident.
- Do not leave the shoulder strap where an infant can reach it.
  - It may result in an accident by mistakenly wrapping around the neck.

## Charging the Battery

### ■ About batteries you can use with this camera

It has been found that counterfeit batteries which look very similar to the genuine product are made available to purchase in some markets. Some of these batteries are not adequately protected with internal protection to meet the requirements of appropriate safety standards. There is a possibility that these batteries may lead to fire or explosion. Please be advised that we are not liable for any accident or failure occurring as a result of use of a counterfeit battery. To ensure safe operation we urgently recommend to use only the Leica battery BP-DC10 E/U (P7).

- Use only the specified charger and battery.
- The camera has a function for distinguishing batteries which can be used safely. The dedicated battery supports this function. The only batteries suitable for use with this camera is the Leica battery BP-DC10 E/U (P7). (Batteries which do not support this function cannot be used.) Leica cannot in any way guarantee the quality, performance or safety of any other batteries.

### ■ Charging

- The battery is not charged when the camera is shipped. Charge the battery before use.
- Charge the battery with the charger indoors.
- It is recommended to charge the battery in a temperature between 10 °C to 30 °C (50 °F to 86 °F). (The battery temperature should also be the same.)

#### 1 Insert the battery into the charger.

- The terminals should face the charger's contacts and the Leica logo upwards.

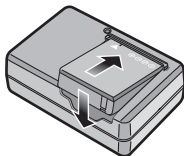



## 2 Connect the charger to the electrical outlet.

- Disconnect the charger from the electrical socket and detach the battery after charging is completed.
- The AC cable does not fit entirely into the AC input terminal. A gap will remain as shown on the right.

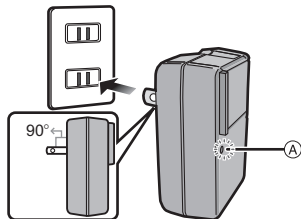

cable type

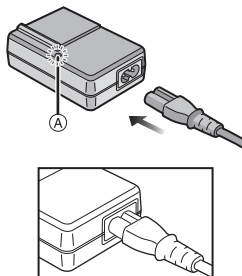

### ■ About the [CHARGE] indicator

The [CHARGE] indicator (A) turns on:

Charging has started.

The [CHARGE] indicator (A) turns off:

Charging has been completed without any problem.

### • When the [CHARGE] indicator flashes

- The battery temperature is too high or too low. It is recommended to charge the battery again in an ambient temperature of between 10 °C to 30 °C (50 °F to 86 °F).
- The terminals of the charger or the battery are dirty. In this case, wipe them with a dry cloth.

## ■ Charging time

Charging time	Approx. 155 min
---------------	-----------------

- The indicated charging time is for when the battery has been discharged completely. The charging time may vary depending on how the battery has been used. The charging time for the battery in hot/cold environments or a battery that has not been used for a long time may be longer than normal.

## ■ Battery indication

The battery indication is displayed on the screen\*.

- \* "Screen" refers to both the LCD monitor and the Electronic Viewfinder EVF1 (available as accessory, see P7), whichever is selected.



- The indication turns red and flashes if the remaining battery power is exhausted. (The status indicator flashes when the LCD monitor turns off.) Recharge the battery or replace it with a fully charged battery.

### Note

- The battery becomes warm after using it and during and after charging. The camera also becomes warm during use. This is not a malfunction.
- The battery can be recharged even when it still has some charge left, but it is not recommended that the battery charge be frequently topped up while the battery is fully charged. (Since characteristic swelling may occur.)
- **Do not leave any metal items (such as clips) near the power plug terminals. Otherwise, a fire and/or electric shocks may be caused by short-circuiting or the resulting heat generated.**

## Approximate operating time and number of recordable pictures

### ■ Recording still pictures

[when using the LCD monitor/the Electronic Viewfinder EVF1 (available as accessory, see P7)]

<b>Number of recordable pictures</b>	<b>Approx. 400 pictures</b>	By CIPA standard in Program Mode
<b>Recording time</b>	<b>Approx. 200 min</b>	



### Recording conditions by CIPA standard

- CIPA is an abbreviation of [Camera & Imaging Products Association].
- Temperature: 23 °C (73.4 °F)/Humidity: 50%RH when LCD monitor is on.
- Using a 32 MB SD Memory Card.
- Using the supplied battery.
- Starting recording 30 seconds after the camera is turned on. (When the Optical Image Stabilizer function is set to [AUTO].)
- **Recording once every 30 seconds** with full flash every second recording.
- Rotating the zoom lever from Tele to Wide or vice versa in every recording.
- Turning the camera off every 10 recordings and leaving it until the temperature of the battery decreases.

**The number of recordable pictures varies depending on the recording interval time. If the recording interval time becomes longer, the number of recordable pictures decreases. [For example, if you were to take one picture every two minutes, then the number of pictures would be reduced to approximately one-quarter of the number of pictures given above (based upon one picture taken every 30 seconds).]**

## ■ Recording motion pictures

[when using the LCD monitor/the Electronic Viewfinder EVF1 (available as accessory, see P7)]

	[AVCHD Lite] (Recording with picture quality set to [SH] ([  ]))	[MOTION JPEG] (Recording with picture quality set to [HD] ([  ]))
<b>Continuous recordable time (motion pictures)</b>	Approx. 140 min	Approx. 140 min
<b>Actual recordable time (motion pictures)</b>	Approx. 70 min	Approx. 70 min

- These times are for an ambient temperature of 23 °C (73.4 °F) and a humidity of 50%RH. Please be aware that these times are approximate.
- Actual recordable time is the time available for recording when repeating actions such as switching the power supply [ON]/[OFF], starting/stopping recording, zoom operation etc.
- **With camera models 18 151 / 18 152:**  
Motion pictures can be recorded continuously in [MOTION JPEG] up to a capacity of 2 GB. Only the maximum recordable time for 2 GB is displayed on the screen. Maximum time to record motion pictures continuously with [AVCHD Lite] is 13 hours 3 minutes 20 seconds. Screen will only display up to 13 hours 3 minutes 20 seconds. However, the recording may stop before that depending on the remaining battery level.
- **With camera model 18 150:**  
Motion pictures can be recorded continuously for up to 29 minutes. Also, motion pictures can be recorded continuously in [MOTION JPEG] up to a capacity of 2 GB. (Example: [8m 20s] with []) Remaining time for continuous recording is displayed on the screen.

## ■ Playback

[when using the LCD monitor/the Electronic Viewfinder EVF1 (available as accessory, see P7)]

<b>Playback time</b>	Approx. 360 min
----------------------	-----------------

### Note

- **The operating times and number of recordable pictures will differ according to the environment and the operating conditions.**  
For example, in the following cases, the operating times shorten and the number of recordable pictures is reduced.
  - In low-temperature environments, such as on ski slopes.
  - When using [AUTO POWER LCD] or [POWER LCD] (P32).
  - When operations such as flash and zoom are used repeatedly.
- When the operating time of the camera becomes extremely short even after properly charging the battery, the life of the battery may have expired. Buy a new battery.

## Inserting and Removing Card and Battery

- Check that the camera is turned off.
- Close the flash.

**1** Set the camera ON/OFF switch to OFF, slide the release lever in the direction of the arrow, and open the card/battery door.

- Use only the Leica battery BP-DC10 E/U (P7).
- We cannot guarantee the quality of any other batteries.

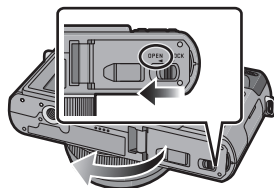

**2** Insert battery and card. Be sure to insert in the correct orientation.

**Battery:** Push it in until it is locked by the lever (A). To remove, pull this lever in the direction of the arrow.

**Card:** Push it down until it clicks into place. To remove, push it further down until it clicks, then pull it out upright.

- (B): Do not touch the connection terminals of the card.
- The card may be damaged if it is not fully inserted.

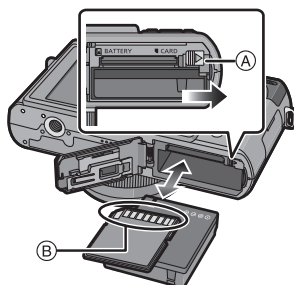

**3** **1:** Close the card/battery door.

**2:** Slide the release lever in the direction of the arrow.

- If the card/battery door cannot be completely closed, remove the card, check its direction and then insert it again.

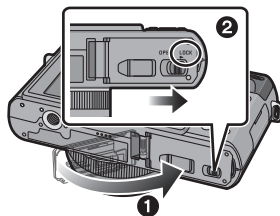



 **Note**

- Remove the battery after use. Store the removed battery in the battery case (supplied).
- Do not remove the battery until the LCD monitor and the status indicator (green) turn off as the settings on the camera may not be stored properly.
- The supplied battery is designed only for the camera. Do not use it with any other equipment.
- The battery will be exhausted if left for a long period of time after being charged.
- Before removing the card or battery, turn the camera off, and wait until the status indicator has gone off completely. (Otherwise, this camera may no longer operate normally and the card itself may be damaged or the recorded pictures may be lost.)

## About the Internal Memory/the Card

The camera can store image data as follows.

- **When no card is inserted:** Pictures are recorded and played back in/from the internal memory.
- **When a card is inserted:** Pictures are recorded and played back on/from the card.
- **When using the internal memory**  
 →  (access indication\*)
- **When using the card**  
 (access indication\*)

\* The access indication lights up in red when pictures are being recorded on the internal memory (or the card).



### Internal Memory

- **You can copy the recorded pictures to a card. (P176)**
- **Memory size: Approx. 40 MB**
- **Recordable motion pictures: QVGA (320×240 pixels) only**
- The internal memory can be used as a temporary storage device when the card being used becomes full.
- The access time for the internal memory may be longer than the access time for a card.

## Card

The following cards which conform to the SD video standard can be used with the camera.

Type of card which can be used with the camera	Remarks
<b>SD Memory Card (8 MB to 2 GB)</b>	<ul style="list-style-type: none"> <li>• SDHC Memory Card can be used with SDHC Memory Card or SDXC Memory Card compatible equipment.</li> <li>• SDXC Memory Card can only be used with SDXC Memory Card compatible equipment.</li> <li>• Check that the PC and other equipment are compatible when using the SDXC Memory Cards.</li> </ul>
<b>SDHC Memory Card (4 GB to 32 GB)</b>	
<b>SDXC Memory Card (48 GB, 64 GB)</b>	

- Only cards bearing the SDHC logo (indicating that the card conforms to SD video standards) may be used as 4 GB to 32 GB cards.
- Only cards bearing the SDXC logo (indicating that the card conforms to SD video standards) may be used as 48 GB and 64 GB cards.
- Use a card with SD Speed Class\* with "Class 4" or higher when recording motion pictures in [AVCHD Lite]. Also, use a card with SD Speed Class with "Class 6" or higher when recording motion pictures in [MOTION JPEG].

\* SD Speed Class is the speed standard regarding continuous writing.

 **Note**

- **Do not turn the camera off, remove its battery or card when the access indication is lit [when pictures are being written, read or deleted, or the internal memory or the card is being formatted (P40)]. Furthermore, do not subject the camera to vibration, impact or static electricity.**

**The card or the data on the card may be damaged, and the camera may no longer operate normally.**

**If operation fails due to vibration, impact or static electricity, perform the operation again.**

- Write-Protect switch (A) provided (When this switch is set to the [LOCK] position, no further data writing, deletion or formatting is possible. The ability to write, delete and format data is restored when the switch is returned to its original position.)
- The data on the internal memory or the card may be damaged or lost due to electromagnetic waves, static electricity or breakdown of the camera or the card. We recommend storing important data on a PC etc.
- Do not format the card on your PC or other equipment. Format it on the camera only to ensure proper operation. (P40)
- Keep the Memory Card out of reach of children to prevent swallowing.





## Setting Date/Time (Clock Set)

- The clock is not set when the camera is shipped.

### 1 Turn the camera on.

(A) [MENU/SET] button

(B) Cursor buttons

- If the language select screen is not displayed, proceed to step 4.

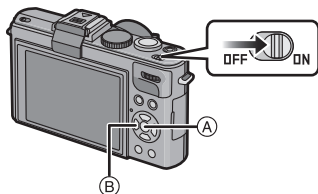

### 2 Press [MENU/SET].

### 3 Press ▲/▼ to select the language, and press [MENU/SET].

- The [PLEASE SET THE CLOCK] message appears.

### 4 Press [MENU/SET].

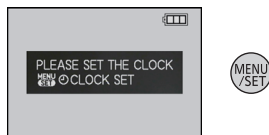

**5** Press ◀/▶ to select the items (year, month, day, hour, minute, display sequence or time display format), and press ▲/▼ to set.

(A): Time at the home area

(B): Time at the travel destination (P122)

- Select either [24HRS] or [AM/PM] for the time display format.
- AM/PM is displayed when [AM/PM] is selected.
- When [AM/PM] is selected as the time display format, midnight is displayed as AM 12:00 and noon is displayed as PM 12:00. This display format is common in the US and elsewhere.
- You can cancel without setting the clock by pressing [RECALL].

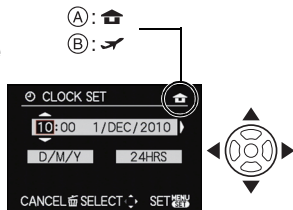

**6** Press [MENU/SET] to set.

**7** Press [MENU/SET].

- Press [RECALL] to return to the settings screen.
- After completing the clock settings, turn the camera off. Then turn the camera back on, and check that the display reflects the settings that were performed.
- When [MENU/SET] has been pressed to complete the settings without the clock having been set, set the clock correctly by following the “Changing the Clock Setting” procedure below.

## Changing the Clock Setting

Select [CLOCK SET] in the [REC] or [SETUP] menu, and press ▶. (P28)

- It can be changed in steps 5 and 6 to set the clock.
- **The clock setting is maintained for 3 months using the built-in clock battery even without the battery. (Leave the charged battery in the camera for 24 hours to charge the built-in battery.)**









### Note

- The clock is displayed when [DISPLAY] is pressed several times during recording.
- You can set the year from 2000 to 2099.
- If the clock is not set, the correct date cannot be printed when you stamp the date on the pictures with [TEXT STAMP] (P164) or order a photo studio to print the pictures.
- If the clock is set, the correct date can be printed even if the date is not displayed on the screen of the camera.

## Setting the Menu

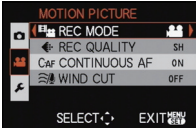
The camera comes with menus that allow you to choose the settings for taking pictures and playing them back as you like and menus that enable you to have more fun with the camera and use it more easily.

In particular, the [SETUP] menu contains some important settings relating to the camera's clock and power. Check the settings of this menu before proceeding to use the camera.

<p> <b>[REC] Mode menu (P124 to 150)</b></p> <ul style="list-style-type: none"> <li>This menu lets you set the Coloring, Sensitivity or Number of pixels, etc. of pictures you are recording.</li> </ul> 	<p><b>MODE [PLAYBACK MODE] menu (P58, 154 to 158)</b></p> <ul style="list-style-type: none"> <li>This menu lets you select the setting of the playback methods such as Playback or Slide Show of only the pictures set as [FAVORITE].</li> </ul> 
<p> <b>[MOTION PICTURE] Mode menu (P151 to 152)</b></p> <ul style="list-style-type: none"> <li>This menu lets you set the [REC MODE], [REC QUALITY], and other aspects for motion picture recording.</li> </ul> 	<p> <b>[PLAYBACK] Mode menu (P161 to 176)</b></p> <ul style="list-style-type: none"> <li>This menu lets you set the Protection, Cropping or Print Settings, etc. of recorded pictures.</li> </ul> 
<p> <b>[SETUP] menu (P31 to 40)</b></p> <ul style="list-style-type: none"> <li>This menu lets you perform the clock settings, select the operating beep tone settings and set other settings which make it easier for you to operate the camera.</li> <li>The [SETUP] menu can be set from either the [REC] Mode or [PLAYBACK] Mode.</li> </ul> 	

### Note

- Due to the camera's specifications, it may not be possible to set some of the functions or some functions may not work in some of the conditions under which the camera is used.

## Setting menu items

This section describes how to select the [REC] Mode menu settings. The same setting can also be used for the [MOTION PICTURE], [PLAYBACK], and [SETUP] menus.

Example: Setting [AF MODE] from [ ] to [ ] in the Program Mode

### 1 Turn the camera on.

(A) [MENU/SET] button

### 2 Set the mode dial to [P].

- To set the playback menu, proceed to step 3 by pressing the [ ].

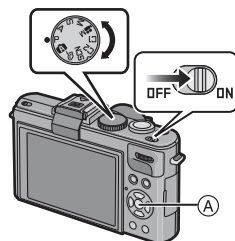

### 3 Press [MENU/SET] to display the menu.

(B) Menu toggle icon

(C) Menu item

(D) Menu screen page

(E) Settings

- You can easily switch menu screen pages by rotating the zoom lever.

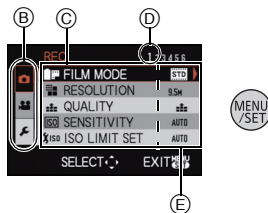

### 4 Press ▲/▼ to select [AF MODE].

- Select the item at the very bottom, and press ▼ to move to the second screen.

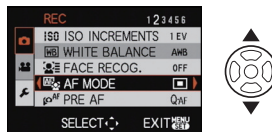

### 5 Press ►.

- Depending on the item, its setting may not appear or it may be displayed in a different way.

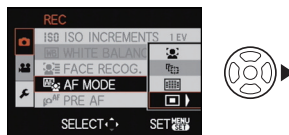

### 6 Press ▲/▼ to select [ ].



**7** Press [MENU/SET] to set.

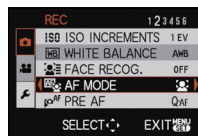

**8** Press [MENU/SET] to close the menu.

Switching to other menus

e.g.: Switching to the [SETUP] menu

- 1** Press [MENU/SET] to display the menu.
- 2** Press ◀.
- 3** Press ▼ to select the [SETUP] menu icon [⌘].
- 4** Press ▶.
  - Select a menu item next and set it.

## Using the Quick Menu

By using the Quick Menu, some of the menu settings can be easily found.

• Some of the menu items cannot be set by the modes.

**1** Press [Q.MENU] when recording.

**2** Press ▲/▼/◀/▶ to select the menu item and the setting and then press [MENU/SET] to close the menu.



Ⓐ The items to be set and the settings are displayed.

• You can set the following items in detail by pressing [DISPLAY].  
 [WHITE BALANCE] (P131)/[AF MODE] (P134)

Perform these settings if you need to.

## About the Setup Menu

[CLOCK SET], [ECONOMY] and [AUTO REVIEW] are important items. Check their settings before using them.

• In the Snapshot Mode, only [CLOCK SET], [WORLD TIME], [BEEP], [LANGUAGE] and [O.I.S. DEMO.] (P40) can be set.

For details on how to select the [SETUP] menu settings, refer to P28.

[CLOCK SET]	Setting Date/Time.
-------------	--------------------

• Refer to P25 for details.

[WORLD TIME]	Set the time in your home area and travel destination.	
	[DESTINATION]: Travel destination area	[HOME]: Your home area

• Refer to P122 for details.

[TRAVEL DATE]	Set the departure date and the return date of the vacation.	
	[TRAVEL SETUP] [OFF]/[SET]	[LOCATION] [OFF]/[SET]

• Refer to P119 for details.



[BEEP]	This allows you to set the beep and shutter sound.	
	[BEEP LEVEL]: (Muted) (Low) (High)	[SHUTTER VOL.]: (Muted) (Low) (High)
	[BEEP TONE]: [1]/[2]/[3]	[SHUTTER TONE]: [1]/[2]/[3]

[VOLUME]	Adjust the volume of the speaker to any of 7 levels.
----------	--

• When you connect the camera to a TV, the volume of the TV speakers does not change.

C  [CUST. SET MEM.]	Up to 4 current camera settings can be registered as custom settings. (Recording Mode only)
	[C 1]/[C 2-1]/[C 2-2]/[C 2-3]

- Refer to P90 for details.

Fn  [Fn BUTTON SET]	Assign Menu to ▼ button. It is convenient to register a Menu that is used often. (Recording Mode only)
	[FILM MODE]/[QUALITY]/[METERING MODE]/[WHITE BALANCE]/[AF MODE]/[I.EXPOSURE]/[GUIDE LINE]/ [  REC AREA]/[REMAINING DISP.]/[FLASH]/ [AUTO BRACKET]/[ASPECT BRACKET]



- Refer to P124 for details about the [REC] Mode menu.
- [Fn BUTTON SET] may be disabled depending on the settings.

LCD  [LCD MODE]	These menu settings make it easier to see the LCD monitor when you are in bright places.
	[OFF] [A*] [AUTO POWER LCD]: The brightness is adjusted automatically depending on how bright it is around the camera. [P*] [POWER LCD]: The LCD monitor becomes brighter and easier to see even when taking pictures outdoors.

- The brightness of the pictures displayed on the LCD monitor is increased so some subjects may appear different from real life on the LCD monitor. However, this does not affect the recorded pictures.
- The LCD monitor automatically returns to normal brightness after 30 seconds when recording in Power LCD Mode. Press any button to make the LCD monitor bright again.
- If the screen is difficult to see because of bright light shining on it, use your hand or another object to block the light.
- The number of recordable pictures decreases in Auto Power LCD Mode and Power LCD Mode.
- [AUTO POWER LCD] cannot be selected in Playback Mode.

A  [DISPLAY SIZE]	Change the display size of some icons and menu screens.
	[STANDARD]/[LARGE]





 [GUIDE LINE]	Set the pattern or position of the guidelines displayed when taking pictures. You can also set whether or not to have the recording information displayed when the guidelines are displayed. (P64)
	<b>[REC. INFO]:</b> <b>[OFF]</b> <b>[ON]</b>
	<b>[PATTERN]:</b>   <b>[ ]:</b> Position of the guide line can be set. Refer to P65 for how to set.

- The [PATTERN] setting is fixed to  in the Snapshot Mode.

 [HISTOGRAM]	This allows you to set either to display or not display the histogram. (P66)
	<b>[OFF]/[ON]</b>

 [REC AREA]	Angle of view for motion picture recording can be checked.
	<b>[OFF]/[ON]</b>

- Motion picture recording frame display is only an approximation.
- Recording frame display may disappear when zooming to Tele depending on the resolution setting.
- This cannot be used during Snapshot Mode.

 [REMAINING DISP.]	This will switch display between the number of recordable pictures and available recording time.
	 <b>[REMAINING SHOTS]:</b> This will display the number of recordable pictures for still pictures.
	 <b>[REMAINING TIME]:</b> This will display the available recording time for motion pictures.

 <b>[HIGHLIGHT]</b>	When the Auto Review function is activated or when playing back, white saturated areas appear flashing in black and white.
	<b>[OFF]/[ON]</b>

- If there are any white saturated areas, we recommend compensating the exposure towards negative (P77) referring to the histogram (P66) and then taking the picture again. It may result in a better quality picture.

- There may be white saturated areas if the distance between the camera and the subject is too close when taking pictures with the flash.

If [HIGHLIGHT] is set to [ON] in this case, the area directly illuminated by the photo flash will become white saturated and appear flashing in black and white.

- Highlighting does not work during Multi-Playback (P59), Calendar Search (P161), Playback Zoom (P60), or Motion Picture Playback (P159).

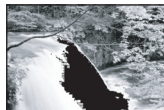
**[ON]****[OFF]**

 <b>[LENS RESUME]</b>	It is possible to memorize the zoom position and the MF (Manual Focus) position when the power is switched [OFF].
	<b>[ZOOM RESUME]:</b> It will automatically return to the zoom position when the power was switched [OFF], next time you turn the power [ON]. <b>[OFF]/[ON]</b>
	<b>[MF RESUME]:</b> It will memorize the MF position set with the Manual Focus. It will resume the memorized Manual Focus position when you return to Manual Focus recording. <b>[OFF]/[ON]</b>

- MF position will be memorized in the following cases:
  - Turning the camera off
  - When the focus selector switch is switched to anything but [MF]
  - When switched to playback mode
- Zoom position will be set all the way to wide when the [ZOOM RESUME] is set to [OFF].
- When [MF RESUME] is set to [OFF], MF position will be the distance focused at the time of recording in Manual Focus.
- Depending on the recording conditions, the memorized MF positions and resumed MF positions might be different.

MF <sub>Q</sub> [MF ASSIST]	In Manual Focus, the assistance screen appears on the center of the screen to facilitate focusing on the subject.
	<b>[OFF]</b> <b>[MF1]:</b> The center of the screen is enlarged. <b>[MF2]:</b> The center of the screen is enlarged over the whole screen.

- Refer to P84 for details.

ECO [ECONOMY]	You can conserve the battery life by setting these menus. Also, it will turn off the LCD monitor automatically when not in use to prevent discharge of the battery.
	<b>z [SLEEP MODE]:</b> The camera is automatically turned off if the camera has not been used for the time selected on the setting. <b>[OFF]/[2MIN.]/[5MIN.]/[10MIN.]</b>
	<b>OFF [AUTO LCD OFF]:</b> The LCD monitor is automatically turned off if the camera has not been used for the time selected on the setting. <b>[OFF]/[15SEC.]/[30SEC.]</b>

- Press the shutter button halfway or turn the camera off and on to cancel [SLEEP MODE].
- [SLEEP MODE] is set to [5MIN.] in the Snapshot Mode.
- [SLEEP MODE] is fixed to [2MIN.] when [AUTO LCD OFF] is set to [15SEC.] or [30SEC.].
- The status indicator lights while the LCD monitor is turned off. Press any button to turn on the LCD monitor again.
- [AUTO LCD OFF] does not work while operating menu or Playback Zoom.
- [SLEEP MODE] does not work in the following cases.
  - When connecting to a PC or a printer
  - When recording or playing back motion pictures
  - [MULTI EXPO.]
  - During a slide show
- [AUTO LCD OFF] does not work in the following cases.
  - When connecting to a PC or a printer
  - While the Self-Timer is set
  - When recording or playing back motion pictures
  - [MULTI EXPO.]
  - During a slide show
  - While the menu screen is displayed

 <b>[PLAY ON LCD]</b>	<p>If you are using the Electronic Viewfinder EVF1 (available as accessory, see P7), LCD monitor will automatically turn on when Recording Mode is switched to Playback Mode.</p> <p><b>[OFF]/[ON]</b></p>
---	--

- Refer to P65 for details.

 <b>[AUTO REVIEW]</b>	<p>Set the length of time that the picture is displayed after taking it.</p> <p><b>[OFF]</b> <b>[1SEC.]</b> <b>[2SEC.]</b></p> <p><b>[HOLD]:</b> The pictures are displayed until one of the buttons is pressed.</p>
---	--







- The Auto Review function is activated regardless of its setting when using [AUTO BRACKET] (P78), [ASPECT BRACKET] (P79), [MULTI FILM] (P126), [BURST] (P144) and [SELF PORTRAIT] (P94), [HI-SPEED BURST] (P100) and [FLASH BURST] (P101) in Scene Mode.
- In Snapshot Mode, the Auto Review function is fixed to [2SEC.].
- If [HIGHLIGHT] (P34) is set to [ON], white saturated areas appear flashing in black and white when the Auto Review function is activated.
- [AUTO REVIEW] does not work when recording motion pictures.

 <b>[START MODE]</b>	<p>Set whether to start up in [REC] Mode or [PLAYBACK] Mode after turning the power switch [ON].</p> <p><b>[📷]:</b> Enters [REC] Mode after turning on the power. <b>[▶]:</b> Enters [PLAYBACK] Mode after turning on the power.</p>
--	--

- Even when set to [📷], you can enter [PLAYBACK] Mode after turning on the power by pressing the [▶] button while turning the power switch [ON].

 <b>[NO.RESET]</b>	<p>Reset the file number of the next recording to 0001.</p>
--	---

- The folder number is updated and the file number starts from 0001. (P188)
- A folder number between 100 and 999 can be assigned.  
When the folder number reaches 999, the number cannot be reset. We recommend formatting the card (P40) after saving the data on a PC or elsewhere.
- To reset the folder number to 100, format the internal memory or the card first and then use this function to reset the file number.  
A reset screen for the folder number will then appear. Select [YES] to reset the folder number.

 <b>[RESET]</b>	The [REC] or [SETUP] menu settings are reset to the initial settings.
	<ul style="list-style-type: none"> <li>• When the [RESET] setting is selected during recording, the operation that resets the lens is also performed at the same time. You will hear the sound of the lens operating but this is normal and not indicative of malfunctioning.</li> <li>• When the [REC] Mode settings are reset, data registered with [FACE RECOG.] will be also reset, too.</li> <li>• When [SETUP] menu settings are reset, the following settings are also reset. In addition, [ROTATE DISP.] (P170) is set to [ON], and [FAVORITE] (P171) is set to [OFF] in [PLAYBACK] Mode menu. <ul style="list-style-type: none"> <li>– The birthday and name settings for [BABY1]/[BABY2] (P98) and [PET] (P99) in Scene Mode.</li> <li>– The [TRAVEL DATE] (P119) setting. (Departure date, return date, destination)</li> <li>– The [WORLD TIME] (P122) setting.</li> <li>– The [CUST. SET MEM.] (P90) setting.</li> <li>– Position memorized in [LENS RESUME]/[MENU RESUME].</li> <li>– The user's name recorded using [USER'S NAME REC].</li> </ul> </li> <li>• The folder number and the clock setting are not changed.</li> </ul>
 <b>[USB MODE]</b>	<p>Select the USB communication system after or before connecting the camera to your PC or your printer with the USB connection cable (supplied).</p> <p> <b>[SELECT ON CONNECTION]:</b> Select either [PC] or [PictBridge(PTP)] if you connected the camera to a PC or a printer supporting PictBridge.</p> <p> <b>[PictBridge(PTP)]:</b> Set after or before connecting to a printer supporting PictBridge.</p> <p> <b>[PC]:</b> Set after or before connecting to a PC.</p>
	<ul style="list-style-type: none"> <li>• When [PC] is selected, the camera is connected via the “USB Mass Storage” communication system.</li> <li>• When [PictBridge(PTP)] is selected, the camera is connected via the “PTP (Picture Transfer Protocol)” communication system.</li> </ul>
 <b>[VIDEO OUT]</b>	<p>Set to match the colour television system in each country. (Playback Mode only)</p> <p><b>[NTSC]:</b> Video output is set to NTSC system.</p> <p><b>[PAL]:</b> Video output is set to PAL system.</p>
	<ul style="list-style-type: none"> <li>• This will operate when the AV cable or HDMI mini cable (available as accessory, see P7) is connected.</li> </ul>
 <b>[TV ASPECT]</b>	<p>Set to match the type of TV. (Playback Mode only)</p> <p><b>[16:9]:</b> When connecting to a 16:9 screen TV.</p> <p><b>[4:3]:</b> When connecting to a 4:3 screen TV.</p>
	<ul style="list-style-type: none"> <li>• This will work when the AV cable is connected.</li> </ul>

<b>HDMI [HDMI MODE]</b>	Set the format for HDMI output when playing back on a HDMI compatible TV connected with the camera using the optional HDMI mini cable.
	<p><b>[AUTO]:</b> The output resolution is automatically set based on the information from the connected TV.</p> <p><b>[1080i]:</b> The interlace method with 1080 available scan lines is used for output.</p> <p><b>[720p]:</b> The progressive method with 720 available scan lines is used for output.</p> <p><b>[576p]<sup>*1</sup>/[480p]<sup>*2</sup>:</b> The progressive method with 576<sup>*1</sup>/480<sup>*2</sup> available scan lines is used for output.</p>

\*1 When [VIDEO OUT] is set to [PAL]

\*2 When [VIDEO OUT] is set to [NTSC]

• **Interlace method/progressive method**

- i= interlace scanning is scanning the screen with half of the effective scanning lines every  $1/50^{*1}$  ( $1/60^{*2}$ ) seconds, where p= progressive scanning is a high density image signal that is scanning the screen with all the effective scanning lines every  $1/50^{*1}$  ( $1/60^{*2}$ ) seconds. The [HDMI] terminal on the camera is compatible with high definition output [1080i]. It is necessary to have a compatible TV to enjoy progressive and high definition images.
- If the images are not output on the TV when the setting is [AUTO], match with the image format your TV can display, and select number of effective scanning lines. (Please read the instructions for the TV.)
  - This will work when the HDMI mini cable (available as accessory, see P7) is connected.
  - Refer to P178 for details.

<b>HDTV Link [HDTV Link]</b>	Setup enabling the camera to be controlled by the remote control units of HDTV-Link compatible equipment using the HDMI mini cable (available as accessory, see P7).
	<p><b>[OFF]:</b> Operation is performed with the buttons on the camera.</p> <p><b>[ON]:</b> Remote control operation of the HDTV Link compatible equipment is enabled. (Not all operations are possible) Button operation of the main unit will be limited.</p>

- This will work when the HDMI mini cable (available as accessory, see P7) is connected.
- Refer to P181 for details.

 <b>[SCENE MENU]</b>	Set the screen that will appear when a Scene Mode has been selected.
	<b>[OFF]:</b> The recording screen in the currently selected Scene Mode appears. <b>[AUTO]:</b> The [SCENE MODE] menu screen appears.



 <b>[MENU RESUME]</b>	The last operated menu position is saved even if the camera is turned off.
	<b>[OFF]/[ON]</b>

 <b>[USER'S NAME REC]</b>	User's name can be recorded in the picture while taking the picture.
	<b>[OFF]:</b> It will not record the user's name.
	<b>[ON]:</b> It will record the user's name.
	<b>[SET]:</b> It will register (change) the user's name.

- For details on how to enter characters to register (change) the user's name, refer to "Entering Text" on P153.
- User's name cannot be recorded in motion pictures.
- User's name cannot be recorded in RAW pictures.
- User's name cannot be recorded in pictures already taken.
- Recorded user's names cannot be confirmed using the camera.

 <b>[VERSION DISP.]</b>	It is possible to check which version of firmware is on the camera.
---	---

 <b>[FORMAT]</b>	The internal memory or card is formatted. Formatting irretrievably deletes all the data so check the data carefully before formatting.
<ul style="list-style-type: none"> <li>• Use a battery with sufficient battery power when formatting. Do not turn the camera off during formatting.</li> <li>• If a card has been inserted, only the card is formatted. To format the internal memory, remove the card.</li> <li>• If the card has been formatted on a PC or other equipment, format it on the camera again. It may take longer to format the internal memory than the card.</li> <li>• If formatting cannot be performed, contact your Leica dealer or the nearest Leica Customer Service Center.</li> </ul>	

 <b>[LANGUAGE]</b>	Set the language displayed on the screen.
<ul style="list-style-type: none"> <li>• If you set a different language by mistake, select [] from the menu icons to set the desired language.</li> </ul>	

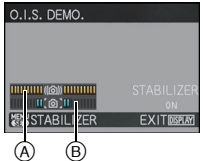
DEMO <b>[O.I.S. DEMO.]</b>	<p>Displays the amount of camera shake that has been detected.</p> <ul style="list-style-type: none"> <li>(A) Amount of camera shake</li> <li>(B) Amount of camera shake after correction</li> </ul> 
----------------------------	--

- The Stabilizer function is switched between [ON] and [OFF] every time [MENU/SET] is pressed during the [O.I.S. DEMO.].
- [O.I.S. DEMO.] is an approximation.
- Press [DISPLAY] to close [O.I.S. DEMO.].



## Mode switching

## Selecting the [REC] Mode to Record Still or Motion Pictures

### 1 Turn the camera on.

(A) Mode dial

- The status indicator (2) lights up when you turn the camera on (1). (It turns off after about 1 second.)

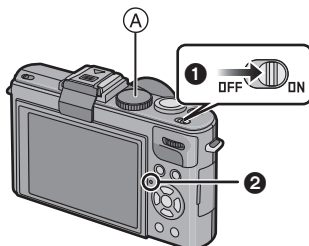

### 2 Change modes by rotating the mode dial.

Align the desired mode with index (B).

- Make sure the dial is set exactly to the click-stop position of the desired mode. (The mode dial rotates 360°)

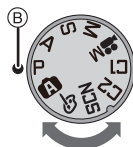

#### ■ Basic

#### **P** Program Mode (P45)

For taking pictures with automatic exposure control.

#### **A** Snapshot Mode (P49)

For taking pictures with extended automatic settings.

■ **Advanced****A** **Aperture-Priority Mode (P81)**

The exposure is determined by the automatically controlled shutter speed, based on the manually set aperture value.

**S** **Shutter-Priority Mode (P81)**

The exposure is determined by the automatically controlled aperture value, based on the manually set shutter speed.

**M** **Manual Exposure Mode (P82)**

The exposure is determined by the manually set aperture value and shutter speed.

 **Creative Motion Picture Mode (P111)**

For recording motion pictures with manual settings.

 **Custom Mode (P91)**

For taking pictures with previously registered settings.

 **Scene Mode (P92)**

For taking pictures that match the scene being recorded.

 **My Color Mode (P87)**

For taking pictures with one of twelve color modes, the effects of which can be checked before on the monitor.

## Tips for taking good pictures

### Ⓐ AF Assist Lamp

- Hold the camera firmly with both hands, keep your arms still at your side and stand with your feet slightly apart.
- Be careful not to move the camera when you press the shutter button.
- Do not cover the flash or the AF Assist Lamp with your fingers or other objects.
- Do not cover the speaker with your fingers.
- Do not touch the front of the lens.

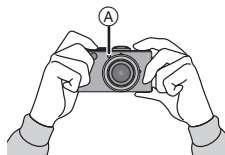

## Select the Aspect Ratio

This allows you to select the aspect ratio of the pictures to suit printing or the playback method.

### Switching the aspect ratio selector switch.

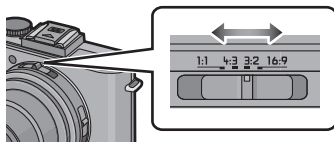

[1:1]	[4:3]	[3:2]	[16:9]
Square aspect ratio	Aspect ratio of a 4:3 TV	Aspect ratio of a 35 mm film camera	Aspect ratio of a high-definition TV, etc.

- The edges of the recorded pictures may be cut off at printing so check before printing. (P219)

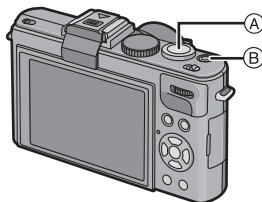

- Ⓐ Shutter button
- Ⓑ Motion picture button

### Taking still pictures

**1** Press the shutter button halfway to focus.

**2** Press the shutter button fully (push it in further), and take the picture.

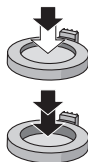

■ For more details, refer to the explanation of each Recording Mode.

### Recording a motion picture

**1** Press the motion picture button to start the recording.

**2** Press the motion picture button again to stop the recording.

- Sound will be turned off when pressing the motion picture button indicating start/stop of motion picture recording.  
Sound volume can be set in [BEEP LEVEL] (P31).

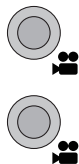

■ Motion Picture recording appropriate for each mode is possible. For more details, refer to “Recording Motion Pictures” (P104).

[REC] Mode: **P**

## Program Mode

The camera automatically sets both shutter speed and aperture value according to the brightness of the subject.

You can change various settings in the [REC] menu.

### 1 Set the mode dial to **[P]**.

- Set the focus selector switch to [AF].
- To change the setting while taking pictures, refer to "Using the [REC] Mode Menu" (P124).

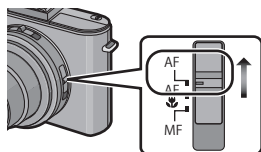
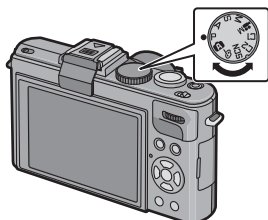

### 2 Aim the AF frame ① at the point you want to focus on.

### 3 Press the shutter button halfway to focus.

- The focus indication ② (green) lights up when the subject is focused.
- The focus range is 50 cm (1' 7 11/16") to ∞.
- If pictures are to be taken at an even closer range, refer to "Close-up Pictures" (P73).

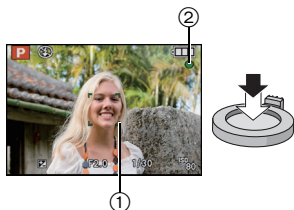

### 4 Press the shutter button fully to take a picture.

- The access indication (P23) lights up in red when pictures are being recorded on the internal memory (or the card).



- Setting the color tone of the picture by using the [REC] Mode menu (P124)
- When taking pictures using the Built-in flash (P67)
- When taking pictures using the Zoom (P54)
- To adjust the exposure and take pictures when the image appears too dark (P77)
- To adjust the colors and take pictures when the image appears too red (P131)
- When recording motion pictures (P104)

## Focusing

Aim the AF area at the subject, and then press the shutter button halfway.

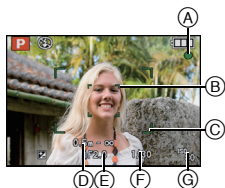

Focus	When the subject is focused	When the subject is not focused
<b>Focus indication</b>	On	Flashes
<b>AF area</b>	White→Green	White→Red
<b>Sound<sup>*2</sup></b>	Beeps 2 times	Beeps 4 times

- (A) Focus indication
- (B) AF area (normal)
- (C) AF area (when using the Digital Zoom or when it is dark)
- (D) Focus range
- (E) Aperture value<sup>\*1</sup>
- (F) Shutter speed<sup>\*1</sup>
- (G) ISO sensitivity

<sup>\*1</sup> If correct exposure cannot be achieved, it will be displayed in red.  
(However, it will not be displayed in red when the flash is used.)

<sup>\*2</sup> Sound volume can be set in [SHUTTER VOL.] (P31).

## Focusing off-center subjects

- 1 Aim the AF area at the subject, and then **press the shutter button halfway** to fix the focus and exposure.
- 2 **Press and hold the shutter button halfway** while moving the camera as you compose the picture.

- You can repeatedly retry the actions in step 1 before pressing the shutter button fully.



We recommend that you use the **Face Detection** function when taking pictures of people. (P134)

### ■ Subjects and recording conditions which are difficult to focus

- Fast-moving subjects, extremely bright subjects or subjects without contrast
- When the focus range display has appeared in red
- When recording subjects through windows or near shiny objects
- When it is dark or when camera shake occurs
- When the camera is too close to the subject or when taking a picture of both distant and near subjects

## Preventing camera shake

When the camera shake alert [] appears, use [STABILIZER] (P146), a tripod or the Self-Timer (P74).

- Shutter speed will be slower particularly in the following cases. Keep the camera still from the moment the shutter button is pressed until the picture appears on the screen. We recommend using a tripod.
  - Slow sync./Red-Eye Reduction
  - In [PANORAMA ASSIST], [NIGHT PORTRAIT], [NIGHT SCENERY], [PARTY], [CANDLE LIGHT], [STARRY SKY] or [FIREWORKS] in Scene Mode (P92)
  - [HIGH DYNAMIC], [DYNAMIC ART], [DYNAMIC] () in My Color Mode (P87)
  - When the shutter speed is slowed in [MIN. SHTR SPEED] (P143)

## Direction Detection Function

Pictures recorded with the camera held vertically are played back vertically (rotated). (Only when [ROTATE DISP.] (P170) is set to [ON])

- The Direction Detection function may not operate correctly if recording is performed with the camera aimed up or down.
- Motion pictures taken with the camera held vertically are not displayed vertically.

## Program Shift

In Program Mode, you can change the preset aperture value and shutter speed without changing the exposure. This is called Program Shift.

You can make the background more blurred by decreasing the aperture value or record a moving subject more dynamically by slowing the shutter speed.

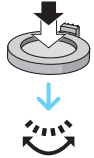

- Press the shutter button halfway and then use the rear dial to activate Program Shift while the aperture value and the shutter speed are displayed on the screen (about 10 seconds).
- The Program Shift indication (A) appears on the screen when Program Shift is activated.
- Program Shift is canceled if the camera is turned off or the rear dial is rotated back until the Program Shift indication disappears, i.e. is set back to 0.

### ■ Example of Program Shift

(A): Aperture value

(B): Shutter speed

- 1 Program Shift range
- 2 Automatic camera setting
- 3 Program Shift limit

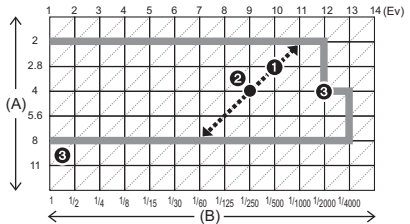

### Note

- If the exposure is not adequate when the shutter button is pressed halfway, the aperture value and shutter speed turns red.
- Program Shift is canceled and the camera returns to normal Program Mode if more than 10 seconds pass after Program Shift is activated. However, the Program Shift setting is memorized.
- Depending on the brightness of the subject, Program Shift may not be available.



[REC] Mode: **A**

## Snapshot Mode

The camera will set the most appropriate settings to match the subject and the recording conditions so we recommend this mode for beginners or those who want to leave the settings to the camera and take pictures easily.

- The following functions are activated automatically.
  - Scene Detection/[STABILIZER]/[INTELLIGENT ISO]/Face Detection/Quick AF/[I.EXPOSURE]/Digital Red-eye Correction/Backlight Compensation/[I.RESOLUTION]/Intelligent Zoom

### 1 Set the mode dial to **A**.

- [MF] cannot be set in **A** (P84).

### 2 Press the shutter button halfway to focus.

- The focus indication ① (green) lights up when the subject is focused.
- The AF frame ② is placed over the subject's face by the Face Detection function. In other cases, it is placed at the point on the subject which is in focus.
- The focus range is 1 cm (3/8") (Wide)/30 cm (1') (Tele) to ∞.
- The maximum close-up distance (the shortest distance at which the subject can be taken) differs depending on the zoom magnification.

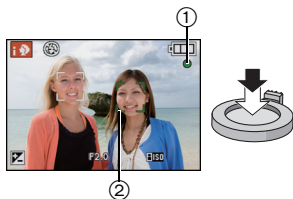

### 3 Press the shutter button fully to take a picture.

- The access indication (P23) lights up in red when pictures are being recorded on the internal memory (or the card).



#### ■ When taking pictures using the Built-in flash (P67)

- Open the flash when the flash is to be used. (P67)
- [iA], [iA⊙], [iS⊙] or [iS] is set depending on the type of subject and brightness.
- When [iA⊙] or [iS⊙] is set, Digital Red-Eye Correction is enabled.
- Shutter speed will be slower during [iS⊙] or [iS].







#### ■ To adjust the exposure and take pictures when the image appears too dark (P77)

#### ■ When recording motion pictures (P104)

- To take pictures using the Face Recognition function (which stores faces of frequent subjects with information such as their names and birthdays) (P113)

## Scene Detection

When the camera identifies the optimum scene, the icon of the scene concerned is displayed in blue for 2 seconds, after which its color changes to the usual red.

A	→		[i- PORTRAIT]	
			[i- SCENERY]	
			[i- MACRO]	
			[i- NIGHT PORTRAIT]	• Only when [i- A] is selected
			[i- NIGHT SCENERY]	
			[i- SUNSET]	
			[i- BABY]*	

- [A] is set if none of the scenes are applicable, and the standard settings are set.
- When [i- P], [i- S] or [i- M] is selected, the camera automatically detects a person's face, and it will adjust the focus and exposure. **(Face Detection) (P135)**
- If a tripod is used, for instance, and the camera has judged that camera shake is minimal when the Scene Mode has been identified as [i- S], the shutter speed will be set to a maximum of 8 seconds. Take care not to move the camera while taking pictures.
- When [FACE RECOG.] is set to [ON], and the face similar to the registered face is detected, [R] is displayed in the top right of [i- P], [i- S] and [i- M].
- \* When [FACE RECOG.] is set to [ON], [i- B] will be displayed for birthdays of registered faces already set only when the face of a person 3 years old or younger is detected.

### Note

- Due to factors such as size, contrast, motion and proximity a different mode may be identified for the same subject.
  - Subject conditions: When the face is bright or dark, the size of the subject, the color of the subject, the distance to the subject, the contrast of the subject, when the subject is moving
  - Recording conditions: Sunset, sunrise, under low brightness conditions, when the camera is shaken, when zoom is used
- For the best results, it is recommended that you take pictures in the appropriate Recording Mode.
- **Backlight Compensation**  
 Backlight refers to situations when the important part of the subject is both considerably smaller than the total frame and also illuminated much less than the rest. Normally, such subjects would be rendered too dark.  
 This function compensates the exposure by brightening the whole picture automatically.

## AF Tracking Function

It is possible to have the focus set to the targeted subject. Focus and exposure will keep following the subject automatically even if it moves.

### 1 Press ▲ (FOCUS).

- [AF-ON] is displayed in the upper left of the screen.
- AF Tracking frame is displayed in the center of the screen.
- Press ▲ (FOCUS) again to cancel.



### 2 Aim the AF Tracking frame at your subject and press [AF/AE LOCK] to lock the subject.

- The AF Tracking frame will turn yellow.
- An optimum scene mode for the framed subject will be chosen.
- Press ▲ (FOCUS) to cancel.

AF/AE LOCK



### Note

- [FACE RECOG.] does not work during AF Tracking.
- You cannot use AF Tracking Function when [COLOR EFFECT] is set to [B/W].
- Please read the Note regarding the AF Tracking on [P136](#).

## Settings in Snapshot Mode

## ■ [REC] Mode menu

[RESOLUTION]\*<sup>1</sup> (P127)/[BURST] (P144)/[COLOR EFFECT]/[FACE RECOG.] (P113)

- [COLOR EFFECT] can set the color effects of [STANDARD], [Happy] or [B/W]. When [Happy] is selected, it is possible to automatically take a picture with a higher level of brilliance for the color brightness and vividness.

## ■ [MOTION PICTURE] Mode menu

[REC MODE] (P108)/[REC QUALITY]\*<sup>1</sup> (P108)

## ■ [SETUP] menu

[CLOCK SET]/[WORLD TIME]/[BEEP]/[LANGUAGE]/[O.I.S. DEMO.]

- The settings of the following items are fixed.

Item	Settings
[GUIDE LINE] (P33)	[] ([REC. INFO.]: [OFF])
[ECONOMY] ([SLEEP MODE]) (P35)	[5MIN.]
[AUTO REVIEW] (P36)	[2SEC.]
[FILM MODE] (P124)	[STANDARD]
[QUALITY] (P129)	[]
[SENSITIVITY] (P75)	[] (Intelligent ISO)* <sup>2</sup> (The maximum ISO sensitivity: [ISO1600])
[ISO LIMIT SET] (P130)	[1600]
[WHITE BALANCE] (P131)	[AWB]
[AF MODE] (P134)	[] (Set to [] when a face cannot be detected* <sup>3</sup> )
[PRE AF] (P138)	[0AF]
[I.EXPOSURE] (P140)	[STANDARD]
[METERING MODE] (P140)	[]
[I.RESOLUTION] (P145)	[STANDARD]* <sup>4</sup>
[i.ZOOM] (P145)	[ON]
[STABILIZER] (P146)	[AUTO]* <sup>5</sup>
[AF ASSIST LAMP] (P147)	[ON]

<b>[FLASH SYNCHRO]</b> <b>(P148)</b>	[1ST]
<b>[RED-EYE REMOVAL]</b> <b>(P149)</b>	[ON]
<b>[CONTINUOUS AF] (P152)</b>	[ON]
<b>[WIND CUT] (P152)</b>	[OFF]

\*1 The settings which can be selected are different from when other [REC] Modes are used.

\*2 Fix to [AUTO] during motion picture recording.

\*3 Fix to [ ] when a face is not recognized during motion picture recording.

\*4 Fix to [OFF] when the Scene Detection is set to [ ], [ ], or [ ].

\*5 Fix to [MODE1] during motion picture recording.

• The following functions cannot be used.

- [FLASH ADJUST.]/[AUTO BRACKET]/[ASPECT BRACKET]/White Balance fine adjustment/  
[AF/AE LOCK]/[MULTI EXPO.]/[DIGITAL ZOOM]/[STEP ZOOM]/[MIN. SHTR SPEED]/  
[HISTOGRAM]/[HIGHLIGHT]
- [MONITOR MODE] on the [REC] Mode menu and the other items in the [SETUP] menu can be set in a mode such as the Program Mode. What is set will be reflected in Snapshot Mode.

[REC] Mode: **A P A S M**  **C1 C2** **SCN** 

## Using the Zoom

### Using the Optical Zoom/Using the Extended Optical Zoom (EZ)/Using the Intelligent Zoom/Using the Digital Zoom

You can increase the focal length to make people and objects appear closer or decrease it to record landscapes in wide angle. To make subjects appear even closer (maximum of  $6.7\times$  larger than with the shortest focal length), do not set the resolution to the highest setting for each aspect ratio (1:1/4:3/3:2/16:9).

The zoom magnification can be increased by approximately  $1.3\times$  without noticeable deterioration in the picture by the Intelligent Resolution Technology when the Intelligent Zoom is used.

Even higher levels of magnification are possible when [DIGITAL ZOOM] is set to [ON] in [REC] menu.

**To make subjects appear closer use longer focal lengths (also narrows the angle of view)**

**Rotate the zoom lever towards T (Tele).**

**To make subjects appear further away use shorter focal lengths (also widens the angle of view)**



**Rotate the zoom lever towards W (Wide).**

■ **Storing the zoom position (Zoom resume)**

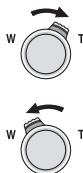
- Refer to [P34](#) for details.



## ■ Types of zooms

Feature	Optical Zoom	Extended Optical Zoom (EZ)
Maximum magnification	3.8×	6.7×*
Picture quality	No deterioration	No deterioration
Conditions	None	[RESOLUTION] with <b>[EZ]</b> (P127) is selected.
Screen display		 (A) <b>[EZ]</b> is displayed.

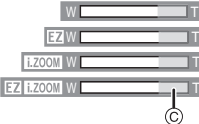
Feature	Intelligent Zoom	Digital Zoom
Maximum magnification	5× (including Optical Zoom 3.8×) 8.9× (including Extended Optical Zoom 6.7×)	15.1× (including Optical Zoom 3.8×) 26.8× (including Extended Optical Zoom 6.7×) 20.1× (including Optical Zoom and [i.ZOOM] 5×) 35.7× (including Extended Optical Zoom and [i.ZOOM] 8.9×)
Picture quality	No noticeable deterioration	The higher the magnification level, the greater the deterioration.
Conditions	[i.ZOOM] (P145) on the [REC] Mode menu is set to [ON].	[DIGITAL ZOOM] (P145) on the [REC] Mode menu is set to [ON].
Screen display	 (B) <b>[i.ZOOM]</b> is displayed.	 (C) The Digital Zoom range is displayed.

• When using the Zoom function, an estimate of the focus range will appear in conjunction with the zoom display bar. (Example: 0.5 m – ∞)

\* The magnification level differs depending on [RESOLUTION] and aspect ratio setting.

## ■ Extended Optical Zoom mechanism

As an example, if you set to [**3M**] (3 million pixels), pictures will be registered with a central section of the sensor, utilizing only 3 million of its total of 10.1 million pixels. This allows you to take more magnified pictures.



### Note

- The indicated zoom magnification is an approximation.
- “EZ” is an abbreviation of “Extended Optical Zoom”.
- The Optical Zoom is set to Wide (1×) when the camera is turned on. Zoom position is as when the power was turned off if the [ZOOM RESUME] (P34) is set to [ON].
- If you use the Zoom function after focusing on the subject, focus on the subject again.
- The lens barrel extends or retracts according to the zoom position. Take care not to interrupt the motion of the lens barrel while the zoom lever is rotated.
- When using the Digital Zoom, [STABILIZER] may not be effective.
- When using the Digital Zoom, we recommend using a tripod and the Self-Timer (P74) for taking pictures.
- In the following cases, [i.ZOOM] is fixed to [ON].
  - Snapshot Mode
  - Scene Mode ([i.ZOOM] cannot be used when in [HIGH SENS.], [HI-SPEED BURST] or [FLASH BURST] in Scene Mode.)
  - [HIGH DYNAMIC], [DYNAMIC ART], [DYNAMIC] (☒) or [FILM GRAIN] in My Color Mode
- [i.ZOOM] cannot be used in the following cases.
  - [PIN HOLE] in My Color Mode
- The Extended Optical Zoom cannot be used in the following cases.
  - In [HIGH SENS.], [HI-SPEED BURST] or [FLASH BURST] in Scene Mode
  - [PIN HOLE] in My Color Mode
  - When recording motion pictures
  - When [QUALITY] is set to [ $\frac{RAW}{2560}$ ], [ $\frac{RAW}{1920}$ ] or [RAW]
  - [MULTI EXPO.]
- [DIGITAL ZOOM] cannot be used in the following cases.
  - Snapshot Mode
  - In [HIGH SENS.], [HI-SPEED BURST] or [FLASH BURST] in Scene Mode
  - [PIN HOLE] or [FILM GRAIN] in My Color Mode
  - When [QUALITY] is set to [ $\frac{RAW}{2560}$ ], [ $\frac{RAW}{1920}$ ] or [RAW]
  - [MULTI EXPO.]



## Using the Step Zoom

When the [STEP ZOOM] (P146) in [REC] Mode menu is set to [ON], a focal length scale with the available positions appears, making it possible to set the desired focal length.

Zooming will stop at the focal lengths of 24 mm, 28 mm, 35 mm, 50 mm, 70 mm, and 90 mm (equivalent to a 35 mm film camera) every time the zoom lever is rotated.

### A Focal length



Current zoom position



- 3 focal lengths for Wide, current zoom position, and Tele are displayed on the screen. (Magnification is not displayed)
- Maximum focal length will change depending on the settings of [RESOLUTION], Extended Optical Zoom, [DIGITAL ZOOM], or [i.ZOOM]. Step Zoom will work with a focal length of up to 800 mm.

### Note

- The focal length is an approximation.
- Value of the focal length will change when Aspect Ratio is set to [1:1].
- [STEP ZOOM] cannot be used in the following cases.
  - Snapshot Mode
  - When recording motion pictures
- Focal length is displayed during playback for the pictures recorded with Step Zoom.

[PLAYBACK] Mode: 

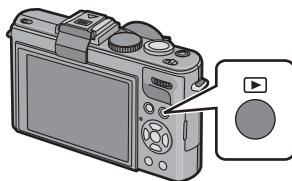

## Playing Back Pictures ([NORMAL PLAY])

**1** Press .**2** Press /  to select the picture.

- (A) File number
- (B) Picture number

: Play back the previous picture

: Play back the next picture

- Speed of picture forwarding/rewinding changes depending on the playback status.
- If you press and hold / , you can play back the pictures in succession.
- It is also possible to forward/rewind pictures by rotating the rear dial.



### ■ To finish playback

Press  again, press the motion picture button or press the shutter button halfway.

### Note

- This camera complies with the DCF standard “Design rule for Camera File system” established by JEITA “Japan Electronics and Information Technology Industries Association” and with Exif “Exchangeable Image File Format”. Files which do not comply with the DCF standard cannot be played back.
- The lens barrel retracts about 15 seconds after switching from [REC] Mode to [PLAYBACK] Mode.

## Displaying Multiple Images

### Rotate the zoom lever towards [W].

1 picture → 12 pictures → 30 pictures → Calendar screen display (P161)

- (A) Number of the selected picture and the total number of recorded pictures
- Rotate the zoom lever towards [T] to return to the previous screen.
  - Pictures are not rotated for display.
  - Pictures displayed using [[!]] cannot be played back.

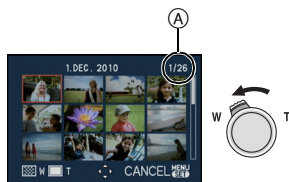

### ■ To return to normal playback

#### 1 Press ▲/▼/◀/▶ to select a picture.

- An icon will be displayed depending on the recorded picture and the settings.
- It is also possible to select pictures by rotating the rear dial.

#### 2 Press [MENU/SET].

- The picture that was selected will appear.
- It is also possible to display pictures by pressing the rear dial.

## Using the Playback Zoom

### Rotate the zoom lever towards [T].

1× → 2× → 4× → 8× → 16×

- When you rotate the zoom lever towards [W] after enlarging the picture, the magnification becomes lower.
- When you change the magnification, the zoom position indication (A) appears for about 1 second, and the position of the enlarged section can be moved by pressing ▲/▼/◀/▶.
- The more its quality is enlarged, the more its quality deteriorates.
- When you move the position to be displayed, the zoom position indication appears for about 1 second.

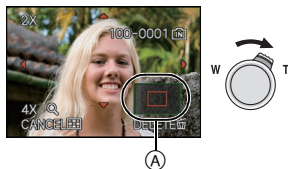

### ■ Switching the displayed image while maintaining the Playback Zoom

#### Rotating the rear dial to select the picture during Playback Zoom.

- You can switch the displayed image while maintaining the same zoom magnification and zoom position for the Playback Zoom.

#### Note

- You can also delete the recording information etc. on the screen during Playback Zoom by pressing [DISPLAY].
- If you want to save the enlarged picture, use the Cropping function. (P168)
- The Playback Zoom may not operate if pictures have been recorded with other equipment.
- The zoom magnification and the zoom position are canceled when the camera is turned off (including Sleep Mode).
- The zoom position returns to the center in the following images.
  - Images with different aspect ratios
  - Images with different numbers of recorded pixels
  - Images with a different rotation direction (when [ROTATE DISP.] is set to [ON])
- Playback Zoom is not available during Motion Picture Playback.

## Enlarge the focus point (display focus point)

The camera can memorize the focus point during the recording, and the resulting picture can be enlarged with that point in the center.

### Press ▲ (FOCUS) during image playback.

- Focus point may not be the center of enlargement when it is at the edge of the image.
- Refer to "Using the Playback Zoom" (P60) for operation during zooming.
- Following pictures cannot be enlarged because there is no focus point:
  - Picture that was taken without focusing
  - Picture that was taken with Manual Focus
  - Picture that was taken with a different camera



## Switching the [PLAYBACK MODE]

- 1 Press [MENU/SET] during playback.
- 2 Press ►.
- 3 Press ▲/▼ to select the item and then press [MENU/SET].

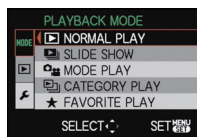

### [NORMAL PLAY] (P58)

All the pictures are played back.

### [SLIDE SHOW] (P154)

The pictures are played back in sequence.

### [MODE PLAY] (P156)

Playback in [PICTURE], [AVCHD Lite]\*1, or [MOTION JPEG] can be selected.

\*1 This is the specification to record and playback high definition images.

### [CATEGORY PLAY] (P157)

The pictures grouped together in categories are played back.

### [FAVORITE PLAY]\*2 (P158)

Your favorite pictures are played back.

\*2 [FAVORITE PLAY] is not displayed when [FAVORITE] has not been set.

[PLAYBACK] Mode: 

## Deleting Pictures

Once deleted, pictures cannot be recovered.

- The picture being played back is deleted, regardless of whether it is recorded on the internal memory or the card.

### Deleting a single picture

- 1** Select the picture to be deleted, and then press .

- (A) [DISPLAY] button
- (B)  button

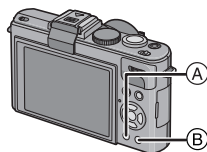

- 2** Press  to select [YES] and then press [MENU/SET].



## Deleting multiple or all the pictures

- 1 Press [🗑️].
- 2 Press ▲/▼ to select [DELETE MULTI] or [DELETE ALL] and then press [MENU/SET].
  - [DELETE ALL] → step 5.
- 3 Press ▲/▼/◀/▶ to select the picture, and then press [DISPLAY] to set. (Repeat this step.)
  - [🗑️] appears on the selected pictures. If [DISPLAY] is pressed again, the setting is canceled.
- 4 Press [MENU/SET].
- 5 Press ▲ to select [YES] and then press [MENU/SET] to set.

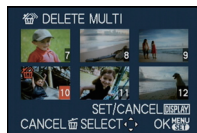

### ■ When [DELETE ALL] has been selected with the [FAVORITE] (P171) setting

The selection screen is displayed again. Select [DELETE ALL] or [ALL DELETE EXCEPT ★], press ▲ to select [YES] and delete the pictures. ([ALL DELETE EXCEPT ★] cannot be selected if no pictures have been set as [FAVORITE].)

#### Note

- Do not turn the camera off while deleting (while [🗑️] is displayed). Use a battery with sufficient battery power.
- If you press [MENU/SET] while deleting pictures using [DELETE MULTI], [DELETE ALL] or [ALL DELETE EXCEPT ★], the deleting will stop halfway.
- Depending on the number of pictures to be deleted, it may take some time to delete them.
- If pictures do not conform to the DCF standard or are protected (P174), they will not be deleted even if [DELETE ALL] or [ALL DELETE EXCEPT ★] is selected.

## Switching the display on the Monitor

Press **[DISPLAY]** to change.

- (A) LCD monitor
- (B) **[DISPLAY]** button

• When the menu screen is displayed, the **[DISPLAY]** button is not functional activated. During Playback Zoom (P60), while playing back motion pictures (P159) and during a slide show (P154), you can only select "Normal display (G)" or "No display (I)".

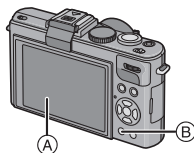

### In Recording Mode

- (C) Normal display\*1, 2
- (D) No display
- (E) No display (Recording guideline)\*1, 3
- (F) No display\*4

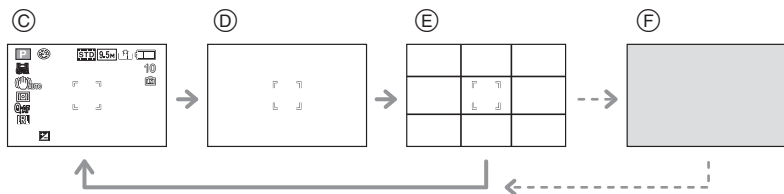

### In Playback Mode

- (G) Normal display
- (H) Display with recording information\*1
- (I) No display

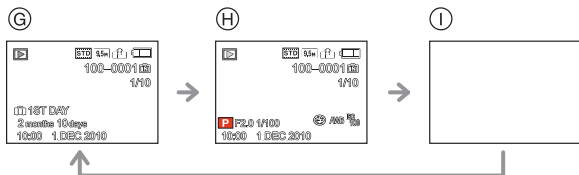

\*1 If the **[HISTOGRAM]** in **[SETUP]** menu is set to **[ON]**, histogram will be displayed.

\*2 You can switch between available recording time and number of recordable pictures by setting **[REMAINING DISP.]** in **[SETUP]** menu.

\*3 Set the pattern of the guidelines displayed by setting **[GUIDE LINE]** in **[SETUP]** menu. It is possible to move the position of the guide line when it is set to **[□□]**. (P65) You can also set whether or not to have the recording information displayed when the guidelines are displayed.

\*4 It is only possible to switch between screens when **[MONITOR MODE]** (P149) in the **[REC]** Mode menu has been set to **[ON]**. The screen is normally off. However elements such as the focus icon (P46) and the flash charging icon are lit.

### Note

• In **[NIGHT PORTRAIT]**, **[NIGHT SCENERY]**, **[STARRY SKY]** and **[FIREWORKS]** in Scene Mode, the guideline is gray. (P92)





## ■ Monitor priority

When [PLAY ON LCD] is set to [ON] on the [SETUP] menu (P36), the LCD monitor is turned on when switching from Recording Mode to Playback Mode.

You can save the time it would take to switch the display to the LCD monitor even when using the Electronic Viewfinder EVF1 (available as accessory, see P7) to record.

## ■ Recording guideline

When you align the subject on the horizontal and vertical guidelines or the cross point of these lines, you can take pictures with well-designed composition by viewing the size, the slope and the balance of the subject.

- (A) : This is used when dividing the entire screen into 3×3 for taking pictures with a well-balanced composition.
- (B) : This is used when you want to position the subject at the exact center of the screen.
- (C) : Position of the guide line can be set. It is used to take well balanced pictures of subjects off the center of the image.

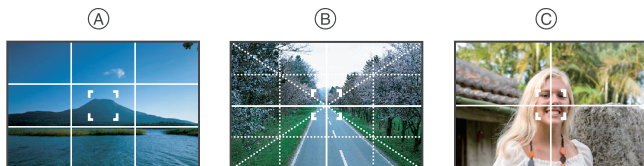

## ■ Set the position of the guide line

- 1 Select [GUIDE LINE] from the [SETUP] menu, and then press **▶**. (P28)
- 2 Press **▼** to select [PATTERN] and then press **▶**.
- 3 Press **▼** to select  and then press [MENU/SET].
- 4 Press **▲/▼/◀/▶** to set the position and then press [MENU/SET] to set.
  - The guide line returns to the center when [DISPLAY] is pressed.
- 5 Press [MENU/SET] to close the menu.
  - You can also press the shutter button halfway to close the menu.



## ■ About the Histogram

A Histogram is a graph that displays brightness along the horizontal axis (black to white) and the number of pixels at each brightness level on the vertical axis. It allows you to easily check a picture's exposure.

### Examples of Histogram

- ① Properly Exposed
  - ② Underexposed
  - ③ Overexposed
- \* Histogram

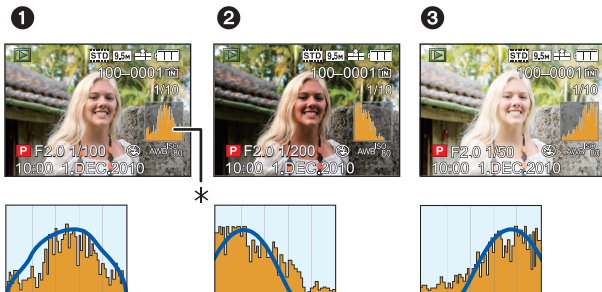

### Note

- When the recorded picture and the histogram do not match each other under the following conditions, the histogram is displayed in orange.
  - When the Manual Exposure Assistance is other than  $[\pm 0EV]$  during exposure compensation or in the Manual Exposure Mode
  - When the flash is activated
  - In [STARRY SKY] or [FIREWORKS] in Scene Mode (P92)
  - When the flash is closed
    - When the brightness of the screen is not correctly displayed in dark places
    - When the exposure is not adequately adjusted
- The Histogram is an approximation in the Recording Mode.
- The Histogram of a picture may not match in the Recording Mode and the Playback Mode.
- The Histogram displayed in this camera does not match Histograms displayed by picture editing software used in PCs etc.
- Histograms are not displayed in the following cases:
  - Snapshot Mode
  - Multi Playback
  - Recording motion pictures
  - Playback Zoom
  - Calendar
  - When HDMI cable is connected

[REC] Mode: **A P A S M C1 C2 SCN** 

## Using the Built-in Flash

**(A)** To open the flash  
Press the flash open switch.

**(B)** To close the flash  
Press the flash unit down until it  
clicks into place.

- Be sure to close the flash when not in use.
- The flash setting is fixed to  while the flash is closed.

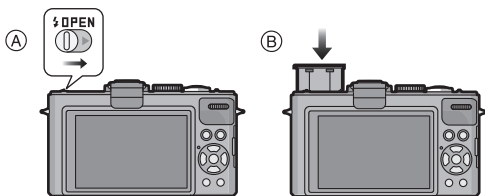

### Note

- Be careful not to catch a finger when closing a flash bulb.

## Switching to the appropriate flash setting

Set the built-in flash to match the recording.

- Open the flash.

**1** Select **[FLASH]** in the **[REC]** mode menu. (P28)







**2** Press **▲/▼** to select a mode and press **[MENU/SET]**.

- For information about flash settings that can be selected, refer to “Available Flash Settings by Recording Mode”. (P69)

**3** Press **[MENU/SET]** to close the menu.



- You can also press the shutter button halfway to finish.







Item	Description of settings
 : AUTO	The flash is automatically fired when the recording conditions make it necessary.
 : AUTO/Red-Eye Reduction*	The flash is automatically fired when the recording conditions make it necessary. It is fired once before the actual recording to reduce the red-eye phenomenon (eyes of the subject appearing red in the picture) and then fired again for the actual recording. • Use this when you take pictures of people in low lighting conditions.
 : Forced Flash ON  : Forced ON/Red-Eye Reduction*	The flash is fired every time regardless of the recording conditions. • Use this when your subject is back-lit or under fluorescent light. • The flash setting is set to [  ] only when you set [PARTY] or [CANDLE LIGHT] in Scene Mode. (P92)
 : Slow sync./Red-Eye Reduction*	If you take a picture with a dark background landscape, this feature will slow the shutter speed when the flash is fired so that the dark background landscape will become bright. Simultaneously it reduces the red-eye phenomenon. • Use this when you take pictures of people in front of a dark background. • Using a slower speed can cause motion blur. Using a tripod can enhance your photos.
 : Forced Flash OFF	The flash is not fired in any recording conditions. • Use this when you take pictures in places where the use of the flash is not permitted.

- \* The flash is fired twice. The subject should not move until the second flash is fired. Interval until the second flash depends on the brightness of the subject.  
[RED-EYE REMOVAL] (P149) on the [REC] Mode menu is set to [ON], [] appears on the flash icon.

### ■ About the Digital Red-Eye Correction

When [RED-EYE REMOVAL] (P149) has been set to [ON] and Red-Eye Reduction ([, [, []) is selected, Digital Red-Eye Correction is performed whenever the flash is used. The camera automatically detects red-eye and corrects the picture.

(Only available when [AF MODE] is set to [] and Face Detection is active)

- Under certain circumstances, red-eye cannot be corrected.
- In the following cases, Digital Red-Eye Correction does not work.
  - When the flash setting is set to [, [] or []
  - When [RED-EYE REMOVAL] is set to [OFF]
  - When [AF MODE] is set to anything except []



## ■ The available flash range to take pictures

- The available flash range is an approximation.

ISO sensitivity	Available flash range	
	Wide	Tele
<b>AUTO</b>	80 cm to 7.2 m*	30 cm to 4.4 m*
<b>ISO80</b>	80 cm to 2.0 m	30 cm to 1.2 m
<b>ISO100</b>	80 cm to 2.3 m	30 cm to 1.3 m
<b>ISO200</b>	80 cm to 3.2 m	30 cm to 1.9 m
<b>ISO400</b>	80 cm to 4.6 m	30 cm to 2.7 m
<b>ISO800</b>	80 cm to 6.5 m	40 cm to 3.9 m
<b>ISO1600</b>	80 cm to 9.2 m	60 cm to 5.5 m
<b>ISO3200</b>	1.15 m to 13.0 m	90 cm to 7.8 m
<b>ISO6400</b>	1.60 m to 18.4 m	1.30 m to 11.1 m
<b>ISO12800</b>	2.30 m to 26.0 m	1.90 m to 15.7 m

\* When the [ISO LIMIT SET] (P130) is set to [AUTO]

- In [HIGH SENS.] (P99) in Scene Mode, the ISO sensitivity automatically switches to between [ISO1600] and [ISO12800] and the available flash range also differs.  
Wide: Approx. 80 cm to approx. 26.0 m  
Tele: Approx. 60 cm to approx. 15.7 m
- In [FLASH BURST] (P101) in Scene Mode, the ISO sensitivity automatically switches to between [ISO100] and [ISO3200] and the available flash range also differs.  
Wide: Approx. 80 cm to approx. 5.6 m  
Tele: Approx. 30 cm to approx. 3.4 m

## ■ Adjust the flash output

Adjust the flash output when the subject is small, or the reflectivity is very high or low.

**1** Select **[FLASH ADJUST.]** from the **[REC] Mode menu**, and then press **▶**. (P28)

**2** Press **◀/▶** to set the flash output and then press **[MENU/SET]**.

- You can adjust from **[-2 EV]** to **[+2 EV]** in steps of **[1/3 EV]**.
- Select **[0 EV]** to return to the original flash output.

**3** Press **[MENU/SET]** to close the menu.



- You can also close the menu by pressing the shutter button halfway.





### Note

- When the flash output is adjusted, the flash output value appears on the upper left of the screen.
- The flash output setting is memorized even if the camera is turned off.
- You cannot set **[FLASH ADJUST.]** in the following cases.
  - In Snapshot Mode
  - In **[FLASH BURST]** in Scene Mode

## ■ Shutter speed for each flash setting

Flash setting	Shutter speed (Sec.)
	1/60*1 to 1/4000s
	
	

Flash setting	Shutter speed (Sec.)
	1*1 to 1/4000s 1 or 1/4 to 1/4000s*2
	

\*1 It may vary depending on the [MIN. SHTR SPEED] setting. (P143)

\*2 When [MIN. SHTR SPEED] is set to [AUTO]. (P143)

- Refer to P83 for details about the Aperture-Priority Mode, Shutter-Priority Mode, and Manual Exposure.
- \*2: The shutter speed becomes a maximum of 1 second in the following cases.
  - When the Optical Image Stabilizer is set to [OFF].
  - When the camera has determined that there is very little camera shake when the Optical Image Stabilizer is set to [MODE1], [MODE2] or [AUTO].
- In Snapshot Mode, shutter speed changes depending on the identified scene.
- In Scene Mode, shutter speed will be different from the above table.



### Note

- **Do not bring the flash too close to objects or close the flash while it is fired. The objects may be discolored by its heat or lighting.**
- Do not close the flash soon after the flash is fired prior to taking pictures due to AUTO/Red-eye reduction etc. It causes a malfunction.
- When you take a picture beyond the available flash range, the exposure may not be adjusted properly and the picture may become too bright or too dark.
- When the flash is being charged, the flash icon flashes in red, and you cannot take a picture even when you press the shutter button fully.
- The White Balance may not be properly adjusted if the flash level is insufficient for the subject.
- The flash effect may not be sufficient when using [FLASH BURST] (P101) in Scene Mode or when shutter speed is fast.
- It may take time to charge the flash if you are taking pictures in quick succession. Take a picture after the access indication disappears.
- The Red-Eye Reduction effect differs between people. Also, if the subject is far away from the camera or was not looking at the first flash, the effect may not be evident.
- When the external flash is installed, it will be prioritized. See P197 for more information on the external flash.



[REC] Mode: **P A S M**  **C1 C2** 

## Close-up Pictures

This mode allows you to take close-up pictures of a subject, e.g. when taking pictures of flowers. You can take pictures of a subject as close as 1 cm from the lens by utilizing the shortest focal length, i.e. the utmost wideangle setting.

### 1 Slide the focus selector switch to [AF ].

- In AF Macro Mode, [AF ] is displayed.

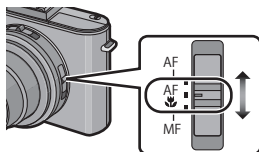

### 2 Take the pictures.



#### ■ Focus range in AF Macro Mode

- \* The focus range changes in steps.

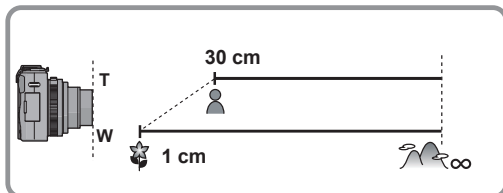

#### Note

- We recommend using a tripod and the Self-Timer.
- We recommend setting the flash to [] when you take pictures at close range.
- If the distance between the camera and the subject is beyond the focus range of the camera, the picture may not be properly focused even if the focus indication lights up.
- When a subject is close to the camera, the effective focus range is significantly smaller. Therefore, if the distance between the camera and the subject is changed after focusing on the subject, it may become difficult to focus on it again.
- AF Macro Mode gives priority to a subject close to the camera. Therefore, if the distance between the camera and the subject is greater, it takes longer to focus on it.
- When you take pictures at close range, the resolution of the periphery of the picture may decrease slightly. This is not a malfunction.

[REC] Mode: **A P A S M C1 C2 SCN** 

## Using the Self-Timer

**1** Press  .



**2** Press / to select a mode.

- You can also press   to select.

**3** Press [MENU/SET].

- You can also press the shutter button halfway to finish.
- The menu screen disappears after about 5 seconds. At this time, the selected item is automatically set.

**4** Press the shutter button halfway to focus and then press it fully to take the picture.

- The Self-Timer indicator  flashes and the shutter is activated after 10 seconds (or 2 seconds).
- If you press [MENU/SET] while the Self-Timer is set, the Self-Timer setting is canceled.

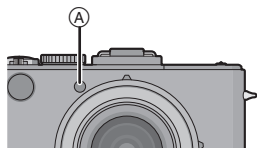
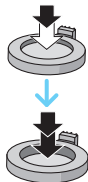

### Note

- When using a tripod etc., setting the Self-Timer to 2 seconds is a convenient way to avoid the camera shake caused by pressing the shutter button.
- When you press the shutter button once fully, the subject is automatically focused just before recording. In dark places, the Self-Timer indicator will flash and then may turn on brightly operating as an AF Assist Lamp (P147) to allow the camera to focus on the subject.
- We recommend using a tripod when recording with the Self-Timer.
- The number of pictures which can be taken in [BURST] is fixed to 3.
- The number of pictures which can be taken in [FLASH BURST] (P101) in Scene Mode is fixed to 5.
- Self-Timer cannot be set to 10 seconds in [SELF PORTRAIT] in Scene Mode.
- Setting of the Self-Timer cannot be performed in the following conditions.
  - In [HI-SPEED BURST] in Scene Mode
  - When recording motion pictures

[REC] Mode: **PASM C1 C2**

## Setting the Sensitivity

The ISO setting determines the possible shutter speed/aperture combinations for a given subject brightness. Higher ISO settings allow faster shutter speeds and/or larger aperture values and vice versa.

### 1 Press **▶** (ISO).

- It can be set from the [REC] Mode menu (P130).

### 2 Press **▲/▼** to select the ISO sensitivity and then press **[MENU/SET]** to set.

- You can also press **▶** (ISO) to select.
- You can also press the shutter button halfway to set.
- The menu screen disappears after about 5 seconds. At this time, the selected item is automatically set.

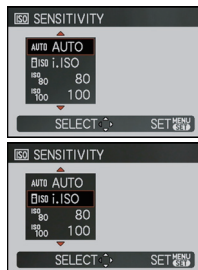

ISO sensitivity	80	12800
Recording location (recommended)	When it is light (outdoors)	When it is dark
Shutter speed	Slow	Fast
Noise	Less	Increased

ISO sensitivity	Settings
<b>AUTO*</b>	The ISO sensitivity is automatically adjusted according to the brightness.
<b>ISO* (Intelligent)</b>	The ISO sensitivity is adjusted according to the movement of the subject and the brightness.
<b>80/100/200/400/800/1600/3200/6400/12800</b>	The ISO sensitivity is fixed to various settings. (When the [ISO INCREMENTS] in [REC] mode menu (P130) is set to [1/3 EV], items of ISO sensitivity that can be set will increase.)

\* When the [ISO LIMIT SET] of [REC] mode menu (P130) is set to anything except [AUTO], it is set automatically within the value set in [ISO LIMIT SET].

It is set as following when the [ISO LIMIT SET] is set to [AUTO].

- When [AUTO] is selected, ISO sensitivity is adjusted automatically depending on brightness within a maximum setting of [ISO400]. ([ISO1000] when the flash is used)
- When setting to [ISO], ISO sensitivity will adjust automatically depending on brightness within the maximum setting of [ISO1600]. ([ISO1000] when the flash is used)

- When [RESOLUTION] is set larger than [25M] (1:1), [3M] (4:3), [3M] (3:2), or [25M] (16:9) with [ISO6400]/[ISO12800] set ([ISO4000] to [ISO12800] when [ISO INCREMENTS] is set to [1/3 EV]), [RESOLUTION] will get lower as shown below:

Aspect ratio setting	Resolution
1:1	75M / 55M / 35M → 25M
4:3	10M / 7M / 5M → 3M
3:2	95M / 65M / 45M → 3M
16:9	9M / 6M / 4.5M → 2.5M

- When [ISO6400]/[ISO12800] is set ([ISO4000] to [ISO12800] when [ISO INCREMENTS] is set to [1/3 EV]), the following functions cannot be used.
  - [RAW], [RAW] or [RAW] in [QUALITY]
  - Extended Optical Zoom
  - [i.ZOOM]
  - [DIGITAL ZOOM]
- The ISO sensitivity will be set to [AUTO] when recording motion pictures. Also, the [ISO LIMIT SET] will not operate.
- Setting items below will be selectable in Creative Motion Picture Mode.
  - [AUTO]/[400]/[800]/[1600]/[3200]/[6400]

### ■ About [iISO] (Intelligent ISO sensitivity control)

The camera automatically sets the optimum ISO sensitivity and shutter speed to suit the movement of the subject, i.e. to ensure its sharpest possible rendition, and also the brightness of the scene.

- The shutter speed is not fixed when the shutter button is pressed halfway. It is continuously changing to match the movement of the subject until the shutter button is pressed fully. Confirm the actual shutter speed on the information display for the picture being played back.

### Note

- The higher the value set for the ISO sensitivity, the sharper moving subjects can be rendered, but the greater the amount of picture noise.
- Refer to P70 for the flash range.
- Depending on the brightness and how fast the subject is moving, unsharp rendition may not be avoided even if [iISO] is selected.
- Movements may not be detected when a moving subject is small, when a moving subject is at the edge of the screen or when a subject has moved at the very moment when the shutter button was pressed fully.
- The setting is fixed to [iISO] in the following cases.
  - In [SPORTS], [BABY1]/[BABY2], [PET] and [FLASH BURST] in Scene Mode
- Program Shift cannot be activated when the ISO sensitivity is set to [iISO].
- You cannot select [iISO] in Shutter-Priority Mode and Manual Exposure Mode.
- Fixed to [AUTO] except for [CUSTOM] in My Color Mode.
- To avoid picture noise, we recommend reducing the ISO sensitivity, setting [NOISE REDUCTION] in [FILM MODE] towards [+ ] or setting the items except [NOISE REDUCTION] towards [- ] to take pictures. (P125)

[REC] Mode: **A P A S** **C1 C2** **SCN**

## Exposure Compensation

Use this function to adjust the exposure to the important part of the subject in case of large differences in brightness within the frame. Look at the following examples.

### Underexposed



Compensate the exposure towards positive.

### Properly exposed



### Overexposed



Compensate the exposure towards negative.

## 1 Press the rear dial to select , and then rotate it to compensate the exposure.

- (A) Exposure compensation value
- Every time the rear dial is pressed, it switches the activated operation.
  - Exposure compensation operation is active when at the bottom left of the screen changes to orange.
  - The exposure compensation value can be set within a range of  $-3$  EV to  $+3$  EV.
  - Select only to return to the original exposure (0 EV).



## 2 Take a picture.

### Note

- EV is an abbreviation of [Exposure Value]. It refers to the amount of light given to the CCD by the aperture value and the shutter speed.
- The exposure compensation value appears on the lower left of the monitor.
- The set exposure value is memorized even if the camera is turned off. However, it is not memorized when using Snapshot Mode.
- The compensation range of the exposure can be limited depending on the brightness of the subject.
- Exposure compensation cannot be used when in [STARRY SKY] in Scene Mode.
- Exposure compensation cannot be used when in [EXPRESSIVE], [RETRO], [PURE], [ELEGANT], [MONOCHROME], [SILHOUETTE] and [CUSTOM] in My Color Mode.

[REC] Mode: **P A S M C1 C2 SCN**

## Using Auto Bracket/Aspect Bracket

### Auto Bracket

In this mode, 3 pictures are automatically recorded with the selected exposure steps each time the shutter button is pressed. You can select the picture with the desired exposure from the 3 pictures with different exposures.

#### With Auto Bracket $\pm 1$ EV

1st picture

 $\pm 0$  EV

2nd picture

 $-1$  EV

3rd picture

 $+1$  EV

- 1 Select **[AUTO BRACKET]** from the **[REC] Mode** menu, and then press **▶**. (P28)
- 2 Press **◀/▶** to set the compensation range of the exposure and then press **[MENU/SET]**.
  - When you do not use Auto Bracket, select **[OFF]** (0).
- 3 Press **[MENU/SET]** to close the menu.
  - You can also press the shutter button halfway to finish.



## Aspect Bracket

Pressing the shutter button once automatically takes four pictures with aspect ratios of [4:3], [3:2], [16:9] and [1:1] (with a single shutter sound).

**1** Select **[ASPECT BRACKET]** from the **[REC] Mode** menu, and then press **▶**. (P28)

**2** Press **▼** to select **[ON]** and then press **[MENU/SET]**.

**3** Press **[MENU/SET]** to close the menu.

- You can also press the shutter button halfway to finish.
- The resulting resolutions are as follows.

[4:3]	→	[3:2]	→	[16:9]	→	[1:1]
10M		9.5M		9M		7.5M
7M		6.5M		6M		5.5M
5M		4.5M		4.5M		3.5M
3M*		3M*		2.5M*		2.5M*

e.g. If setting is 6.5M (3:2)

- 7M (4:3), 6.5M (3:2), 6M (16:9) and 5.5M (1:1).

\*These are the minimum resolutions when the Aspect Bracket setting is selected. If the set resolution is lower than the lowest possible setting, it will be temporarily changed to the lowest resolution.

 **Note**

- When setting Auto Bracket, [] appears on the screen.
- When setting Aspect Bracket, [] appears on the screen.
- When taking pictures using Auto Bracket after setting the exposure compensation range, the pictures taken are based on the selected exposure compensation range. When the exposure is compensated, the exposure compensation value appears on the lower left of the screen.
- The Auto Bracket/Aspect Bracket setting is canceled if you turn the camera off or [SLEEP MODE] is activated.
- When Auto Bracket/Aspect Bracket is set, the Auto Review function is activated regardless of the Auto Review setting. You cannot set the Auto Review function in the [SETUP] menu.
- The exposure may not be compensated with Auto Bracket depending on the brightness of the subject.
- It will take longer to write the picture data when Auto Bracket or Aspect Bracket is used with the internal memory.
- **[] is set for the flash when Auto Bracket is set.**
- **[BURST], [MULTI FILM] or White Balance Bracket is canceled when [AUTO BRACKET] or [ASPECT BRACKET] is set.**
- In Shutter-Priority Mode and Manual Exposure Mode, if the shutter speed is set to more than 1 second, Auto Bracket is canceled.
- **The one set last will take precedence. (Auto Bracket and Aspect Bracket cannot be set simultaneously.)**
- Setting of the Auto Bracket cannot be performed in following conditions.
  - In [PANORAMA ASSIST], [HI-SPEED BURST], [FLASH BURST] and [STARRY SKY] in Scene Mode
  - [EXPRESSIVE], [RETRO], [PURE], [ELEGANT], [MONOCHROME], [SILHOUETTE], [PIN HOLE], [FILM GRAIN] and [CUSTOM] in My Color Mode
  - [MULTI EXPO.]
  - When recording motion pictures
- Setting of the Aspect Bracket cannot be performed in following conditions.
  - In [PANORAMA ASSIST], [HIGH SENS.], [HI-SPEED BURST], [FLASH BURST] and [STARRY SKY] in Scene Mode
  - [EXPRESSIVE], [RETRO], [PURE], [ELEGANT], [MONOCHROME], [SILHOUETTE], [PIN HOLE], [FILM GRAIN] and [CUSTOM] in My Color Mode
  - When [QUALITY] is set to [], [] and [RAW]
  - [MULTI EXPO.]
  - When recording motion pictures



[REC] Mode: **AS**

## Aperture- and Shutter-Priority Modes

### Aperture-Priority Mode

Set the aperture value to a higher number when you want a larger in-focus area (in front of and behind the main subject), to a lower number for a smaller in-focus area.

- 1 Set the mode dial to **[A]**.
- 2 Rotate the rear dial to set the aperture value.
  - (A) Aperture Value
    - Every time the rear dial is pressed, it switches between aperture setting and exposure compensation setting operation.
- 3 Take a picture.



### Shutter-Priority Mode

When you want to take a sharp picture of a fast moving subject, set with a faster shutter speed. When you want to create a trailing effect, set to a slower shutter speed.

- 1 Set the mode dial to **[S]**.
- 2 Rotate the rear dial to set the shutter speed.
  - (B) Shutter Speed
    - Every time the rear dial is pressed, it switches between shutter speed and exposure compensation setting operation.
- 3 Take a picture.



#### Note

- Refer to **P83** for the available aperture values and the shutter speed.
- The brightness of the screen and the recorded pictures may differ. Check the pictures using the Playback Mode.
- Set the aperture value to a higher number when the subject is too bright in Aperture-Priority Mode. Set the aperture value to a lower number when the subject is too dim.
- The aperture value and the shutter speed displayed on the screen turn red when the exposure is not adequate.
- We recommend using a tripod when the shutter speed is slow.
- **[S/O]** cannot be set for Shutter-Priority Mode.

[REC] Mode: **M**

## Manual Exposure Mode

Determine the exposure by manually setting the aperture value and the shutter speed.

### 1 Set the mode dial to **[M]**.

- The Manual Exposure Assistance (A) appears for about 10 seconds.

### 2 Rotate the rear dial to set the aperture and shutter speed.

- (B) Aperture Value
- (C) Shutter Speed

- Every time the rear dial is pressed, it switches between aperture setting and shutter speed setting operation.
- Focus can be set manually when [MF] is displaying. (P84)

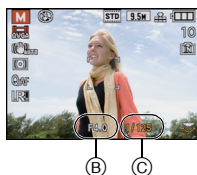

### 3 Press the shutter button halfway.

- The Manual Exposure Assistance (A) appears for about 10 seconds.
- Set the aperture value and the shutter speed again when the exposure is not adequate.



### 4 Take the picture.

#### Manual Exposure Assistance

	The exposure is appropriate.
	Set to faster shutter speed or larger aperture value.
	Set to slower shutter speed or smaller aperture value.

- The Manual Exposure Assistance is an approximation.

#### Note

- Refer to P83 for the available aperture values and the shutter speed.
- The brightness of the screen may differ from the brightness of the actual pictures. Check the pictures using the Playback Mode.
- If the exposure is not adequate, the aperture value and the shutter speed turn red when the shutter button is pressed halfway.
- [] for flash cannot be set.

## Aperture Value and Shutter Speed

### Aperture-Priority Mode

Available Aperture Value (Per 1/3 EV)			Shutter Speed (Sec)
F8.0			8 to 1/4000
F7.1	F6.3	F5.6	
F5.0	F4.5	F4.0	
F3.5	F3.2	F2.8	8 to 1/2000
F2.5	F2.2	F2.0	

### Shutter-Priority Mode

Available Shutter Speed (Sec) (Per 1/3 EV)				Aperture Value
8	6	5	4	F2.0 to F8.0
3.2	2.5	2	1.6	
1.3	1	1/1.3	1/1.6	
1/2	1/2.5	1/3.2	1/4	
1/5	1/6	1/8	1/10	
1/13	1/15	1/20	1/25	
1/30	1/40	1/50	1/60	
1/80	1/100	1/125	1/160	
1/200	1/250	1/320	1/400	
1/500	1/640	1/800	1/1000	
1/1300	1/1600	1/2000		
1/2500	1/3200	1/4000		F4.0 to F8.0

### Manual Exposure Mode

Available Aperture Value (Per 1/3 EV)	Available Shutter Speed (Sec) (Per 1/3 EV)
F2.0 to F3.5	60 to 1/2000
F4.0 to F8.0	60 to 1/4000

#### Note

- The aperture values given in the table above are values when the zoom lever is rotated to Wide.
- Depending on the zoom magnification, some of the aperture values cannot be selected.

[REC] Mode: **P A S M**  **C1 C2** **SCN** 

## Manual Focusing

Use this function when you want to fix the focus or when the distance between the lens and the subject is determined and you do not want to activate Auto Focus.

### 1 Set the focus selector switch to [MF].

- [ MF ] is displayed in the upper left of the screen while in Manual Focus Mode.

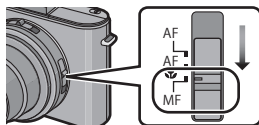

### 2 Press the rear dial a few times to enable the Manual Focus operation.

- Every time the rear dial is pressed, it switches between the different operation modes.
- Manual Focus operation is enabled when [ MF ] at the bottom right of the screen changes to orange.



### 3 Rotate the rear dial.

- Focus range disappears.

### 4 Press ◀/▶ or rotate the rear dial to focus on the subject.

#### (A) Focus range

- It may be difficult to make fine adjustments when using the rear dial. If you have any difficulty, we recommend adjusting using the cursor button.
- Pressing and holding down the cursor button causes the focus position to move continuously.
- MF assistance disappears about 2 seconds after you stop operating the cursor button or the rear dial.
- Focus range disappears about 5 seconds after you stop operating the cursor button or the rear dial.
- During motion picture recording, MF assistance and focus range will not display, but you can focus by pressing ◀/▶, or by using the rear dial.

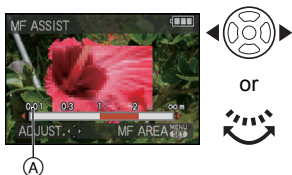

### 5 Take the picture.

## MF ASSIST

If you rotate the rear dial when [MF ASSIST] is set to [MF1] or [MF2], MF assistance is activated and the screen is enlarged allowing you to focus on the subject more easily.

- 1 Select [MF ASSIST] on the [SETUP] menu. (P28)
- 2 Press ▲/▼ to select [MF1] or [MF2] and then press [MENU/SET].

[MF1]	The center of the screen is enlarged. You can adjust the focus while determining the composition of the whole of the screen.
[MF2]	The center of the screen is enlarged over the whole screen. This is convenient for adjusting the focus in wide angle shots for which changes in focus are difficult to grasp.
[OFF]	The screen is not enlarged.

- 3 Press [MENU/SET] to close the menu.
  - You can also press the shutter button halfway to finish.

#### ■ Changing the zoom area

The magnified area can be changed while the screen is expanded using MF Assist. This is convenient when you want to change the focus position to take pictures.

- 1 Rotate the rear dial to display MF assistance on the screen.
- 2 Display MF area (enlarged area) by pressing [MENU/SET].
- 3 Change the area to be expanded with the cursor buttons ▲/▼/◀/▶.
- 4 Press [MENU/SET] to set.



- The following will return the MF assistance to the original position.
  - Changing the resolution or aspect.
  - Turning the camera off.

### ■ Technique for Manual Focus

- 1 Focus by rotating the rear dial.
- 2 Press the cursor button a few more times in the same direction.
- 3 Finely focus on the subject by pressing the cursor button in reverse.

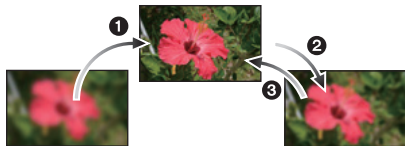

### ■ One shot AF

You can focus on the subject with Auto Focus by selecting [MF] with Focus selector switch and then pressing the ▲ (FOCUS) button.

This is convenient for prefocus.

### ■ Prefocus

This is a technique for focusing in advance on the point the pictures will be taken when it is difficult to focus on the subject with Auto Focus due to its quick motion.

This function is suitable when the distance between the camera and the subject is certain.

### Note

- If you focus on the subject in Wide and then rotate the zoom lever to Tele, the focus may not be adequate. In this case, focus on the subject again.
- The MF assistance does not appear when using the Digital Zoom.
- The distance to the subject displayed on the screen in Manual Focus is an approximation of the focus position. Use the MF assistance screen for a final check of the focus.
- After canceling Sleep Mode, focus on the subject again.
- Using MF assistance in combination with AE Lock makes it easy to check the focus.

[REC] mode: 

## Using My Color Mode

You can take pictures with a desired effect by previewing the subject on the screen and setting the desired effect.

- 1 Set the mode dial to .
- 2 Press  $\blacktriangle/\blacktriangledown$  to select an item.

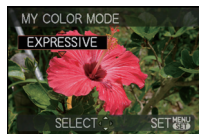

Item	Effect
[EXPRESSIVE]	This is a pop art style image effect that emphasises the color.
[RETRO]	This is a soft image effect that gives the appearance of a tarnished photograph.
[PURE]	This is an image effect that uses a cool, bright light to give a feeling of freshness. (The image will come out bright and slightly bluish.)
[ELEGANT]	This is an image effect that creates a tranquil atmosphere and projects a feeling of stateliness. (The image will come out slightly dark and amberish.)
[MONOCHROME]	This is an image effect that captures the subject using tones characteristic of black and white photography, and with a whisper of color.
[HIGH DYNAMIC]	This is an image effect that pictures dark and bright areas with appropriate brightness and with natural color.
[DYNAMIC ART]	This is an impressive image effect that pictures dark areas to bright areas with appropriate brightness, together with enhancements on colors.
[DYNAMIC] <small>(RAW)</small>	This is a black and white image effect that pictures dark and bright areas with appropriate brightness.
[SILHOUETTE]	This is an image effect that enhances the subject in the shade as a black silhouette by utilising the background colors of the sky or sunset etc.
[PIN HOLE]	Picture is taken darker and with soft focus around the subjects.
[FILM GRAIN]	Picture is taken with a grainy texture as though blasted with sand.
[CUSTOM]*	The color effects can be set according to your preferences.

\*For [CUSTOM] settings, refer to page 89.



Press [MENU/SET] to set.

■ **Readjust the My Color settings**

Return to step 2 on page 87 by pressing [MENU/SET].



**Note**

- **During Motion Picture Recording, settings for My Color Mode are used.**
- My Color settings are memorized even if the camera is turned off.
- [I.EXPOSURE] can be set only when the My Color Mode is set to [CUSTOM].
- The following items cannot be set in My Color Mode because the camera automatically adjusts them to the optimal setting.
  - [FILM MODE]/[ISO LIMIT SET]



## Adjusting the custom settings to achieve desired effects

By selecting [CUSTOM], you can take pictures with color, brightness and saturation adjusted to desired levels.

**1** In step 2 on page 87, select [CUSTOM] and press ►.

**2** Press ▲/▼ to select an item and ◀/▶ to adjust.

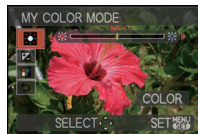

Item	Adjustment contents
[COLOR]	This will adjust the color of the image from red light to blue light. (11 steps in $\pm 5$ )
[BRIGHTNESS]	This will adjust the brightness of the image. (19 steps in $\pm 9$ )
[SATURATION]	This will adjust the color intensity of the image from black and white to vivid color. (11 steps in $\pm 5$ )
[RESET]	Return all settings to default.

**3** Press [MENU/SET] to set.

- You can also press the shutter button halfway to set.

### Return [CUSTOM] settings to default

**1** Select [◀] in above step 2.

**2** Press ◀ to select [YES] and press [MENU/SET].

- Adjusted value for each item returns to standard (center point).

### Note

- Adjustments made with [CUSTOM] are not in effect in other recording modes.
- Icons for the adjusted items are displayed in the screen when the [CUSTOM] are adjusted. Displayed icon is the one for direction of adjustment.
- AF tracking may not function if you adjust [SATURATION] to make the color lighter.

[REC] Mode: **P A S M** **C1 C2** **SCN**

## Registering Personal Menu Settings (Registering custom settings)

It is possible to register up to 4 sets of current camera settings as custom sets.

- Set to the mode dial to the desired mode and select the desired menu settings in advance.

**1** Select [CUST. SET MEM.] on the [SETUP] menu. (P28)

**2** Press  $\blacktriangle/\blacktriangledown$  to select the custom set to register and then press [MENU/SET].

- The custom settings registered in [C 1] can be used with the [**C1**] of the mode dial. It will be convenient if the custom setting used often is registered, since it can be used by just setting the mode dial.
- The custom settings registered in [C 2-1], [C 2-2] or [C 2-3] can be selected in the [**C2**] of the mode dial. Up to 3 custom settings can be registered, so select the one matching the needs.

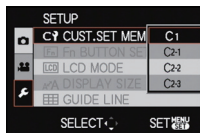

**3** Press  $\blacktriangle$  to select [YES] and then press [MENU/SET].

- When [YES] is selected, the settings that were previously stored are overwritten.

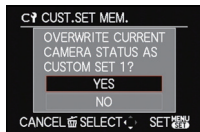

**4** Press [MENU/SET] to close the menu.

- You can also press the shutter button halfway to close the menu.

### Note

- You cannot save the following menu items because they affect other Recording Modes.

[REC] menu/Recording functions	[SETUP] menu
<ul style="list-style-type: none"> <li>• [BABY1]/[BABY2] or [PET] birthday and name settings in Scene Mode</li> <li>• Data registered with [FACE RECOG.]</li> </ul>	<ul style="list-style-type: none"> <li>• [CLOCK SET]</li> <li>• [TRAVEL DATE]</li> <li>• [VOLUME]</li> <li>• [DISPLAY SIZE]</li> <li>• [AUTO REVIEW]</li> <li>• [NO.RESET]</li> <li>• [USB MODE]</li> <li>• [TV ASPECT]</li> <li>• [HDTV Link]</li> <li>• [VERSION DISP.]</li> <li>• [O.I.S. DEMO.]</li> <li>• [WORLD TIME]</li> <li>• [BEEP]</li> <li>• [LCD MODE]</li> <li>• [ECONOMY]</li> <li>• [START MODE]</li> <li>• [RESET]</li> <li>• [VIDEO OUT]</li> <li>• [HDMI MODE]</li> <li>• [SCENE MENU]</li> <li>• [LANGUAGE]</li> </ul>

[REC] Mode: **C1 C2**

## Using Custom Mode

You can select one of your own custom settings saved with [CUST. SET MEM.] to suit the picture-taking conditions.

Initial setting of the Program Mode is registered as the custom settings initially.

### 1 Set the mode dial to **[C1]** or **[C2]**.

Ⓐ Display custom settings

- When set to **[C1]**

→ You can take pictures with the custom settings registered in the [C 1]. ([C 1] is displayed on the screen)

- When set to **[C2]**

→ To steps **2** and **3**

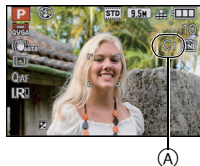

### 2 Press **▲/▼** to select the custom settings you want to use.

- In **[C2]**, press [DISPLAY] to display the settings for each menu item. (Press **◀/▶** to change between screens, and press [DISPLAY] to return to the selection screen.)

- Only the main menu items are displayed.

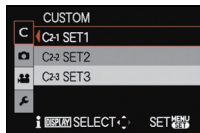

### 3 Press **[MENU/SET]** to enter the settings.

- Saving of the selected custom settings is displayed on the screen.

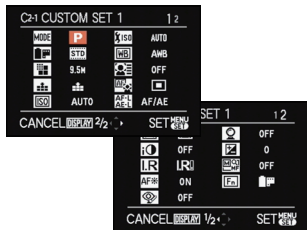

### ■ When changing the menu settings

Even if the menu settings are changed temporarily with [C 1], [C 2-1], [C 2-2] or [C 2-3] selected, what has been registered will remain unchanged.

To change what has been registered, overwrite the registered data using [CUST. SET MEM.] (P90) on the setup menu.

### Note

- See the note on P90 for details of the menu that is not stored in the custom set.

[REC] Mode: **SCN**

## Using Scene Mode

When you select a Scene Mode to match the subject and recording situation, the camera sets the optimal exposure and hue to obtain the desired picture.

**1** Set the mode dial to **[SCN]**.

**2** Press **▲/▼/◀/▶** to select the Scene Mode.

- You can switch menu screens from any menu item by rotating the zoom lever.

**3** Press **[MENU/SET]** to set.

- The menu screen is switched to the recording screen in the selected Scene Mode.

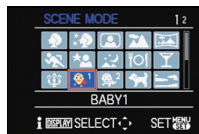

### ■ About the information

- If you press [DISPLAY] when selecting a Scene Mode in step 2, explanations about each Scene Mode are displayed. (If you press [DISPLAY] again, the screen returns to the Scene Mode menu.)



### Note

- To change the Scene Mode, press [MENU/SET] and then press **▶**, and return to step 2 above (when [MENU RESUME] (P39) is [OFF]).
- The Scene Mode flash setting is reset to the initial setting when the Scene Mode is changed.
- When you take a picture with a Scene Mode that is not adequate for the purpose, the hue of the picture may differ from the actual scene.
- The following items cannot be set in Scene Mode because the camera automatically adjusts them to the optimal setting.
  - [FILM MODE]/[SENSITIVITY]/[ISO LIMIT SET]/[ISO INCREMENTS]/[METERING MODE]/[I.EXPOSURE]/[MULTI EXPO.]/[MIN. SHTR SPEED]/[I.RESOLUTION]/[i.ZOOM]/[FLASH SYNCHRO]

**[PORTRAIT]**

When taking pictures of people outdoors during the day, this mode allows you to improve the appearance of the persons concerned and make their skin tones look healthier.

**■ Technique for Portrait Mode**

To make this mode more effective:

- ❶ Use the longest possible focal length (tele).
- ❷ Move close to the subject.

**Note**

- The initial setting for [AF MODE] is [AF-LOCK].
- [I.RESOLUTION] is fixed to [OFF].

**[SOFT SKIN]**

When taking pictures of people outdoors during the daytime, this mode enables the texture of their skin to appear even softer than with [PORTRAIT]. (It is effective when taking pictures of people from the chest up.)

**■ Technique for Soft Skin Mode**

To make this mode more effective:

- ❶ Use the longest possible focal length (tele).
- ❷ Move close to the subject.

**Note**

- If a part of the background has a color similar to the color of the person's skin, the former may also show some smoothing.
- This mode may not achieve the described effects when there is insufficient brightness.
- The initial setting for [AF MODE] is [AF-LOCK].
- [I.RESOLUTION] is fixed to [OFF].

## [SELF PORTRAIT]

Select this to take pictures of yourself.

### ■ Technique for Self Portrait Mode

- Press the shutter button halfway to focus. The Self-Timer indicator lights up when you are brought into focus. Making sure you hold the camera still, press the shutter button fully to take the picture.
- The subject is not focused when the Self-Timer indicator is flashing. Make sure to press the shutter button halfway again to focus.
- The recorded picture automatically appears on the LCD monitor for reviewing.
- If the picture is blurry due to the slow shutter speed, we recommend using the 2 second Self-Timer.



### Note

- The focus range is about 30 cm to 1.2 m.
- The shortest focal length is automatically set.
- The Self-Timer can only be set to off or 2 seconds. If it is set to 2 seconds, this setting will remain until the camera is turned off, the Scene Mode is changed or [REC] Mode or [PLAYBACK] Mode is selected.
- The Stabilizer Function Mode is fixed to [MODE2]. (P146)
- The initial setting for [AF MODE] is [∞].
- [I.RESOLUTION] is fixed to [OFF].

## [SCENERY]

This allows you to take pictures of a wide landscape.

### Note

- **The flash setting is fixed to [☺].**
- The focus range is 5 m to ∞.

## [PANORAMA ASSIST]

You can take pictures with connections suitable for creating panorama images.

## ■ Setting the recording direction

### 1 Press ▲/▼ to select the recording direction and then press [MENU/SET].

- The horizontal/vertical guideline will be displayed.

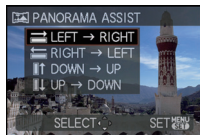

### 2 Take the picture.

- You can retake the picture by selecting [RETAKE].



### 3 Press ▲ to select [NEXT] and then press [MENU/SET].

- You can also press the shutter button halfway to set the menu.
- Part of the recorded image is displayed as a transparent image.

### 4 Take picture after moving the camera horizontally or vertically so the transparent image overlaps.

- When taking the third and later pictures, repeat steps **3** and **4**.
- You can retake the picture by selecting [RETAKE].



### 5 Press ▲/▼ to select [EXIT] and then press [MENU/SET].

#### Note

- It will be a normal motion picture recording during the motion picture recording.
- The flash setting is fixed to [☺].
- [I.RESOLUTION] is fixed to [OFF].
- The focus, zoom, exposure, White Balance, shutter speed and ISO sensitivity are fixed to the settings for the first picture.
- We recommend using a tripod. When it is dark, we recommend using the Self-Timer for taking pictures.
- When the camera is set to [STABILIZER] and there is very little camera shake, or if [STABILIZER] is set to [OFF], shutter speed may slow down up to 8 seconds.
- The shutter may remain closed (max. about 8 sec.) after taking the picture because of signal processing. This is not a malfunction.

**[SPORTS]**

Use this mode to take pictures of sports scenes or other fast-moving events.

**Note**

- It will be a normal motion picture recording during the motion picture recording.
- When the camera is set to [STABILIZER] and there is very little camera shake, or if [STABILIZER] is set to [OFF], shutter speed may slow down up to 1 second.
- This mode is suitable for taking pictures of subjects at distances of 5 m or more.
- Intelligent ISO sensitivity control is activated, and maximum ISO sensitivity level becomes [ISO1600].

**[NIGHT PORTRAIT]**

This allows you to take pictures of a person and the background with near real-life brightness.

**■ Technique for Night Portrait Mode**

- Open the flash (the flash setting will be [⚡☉], indicating a compulsory flash).
- Ask the subject not to move while taking a picture.

**Note**

- During motion picture recording, low light settings [📷] are used, which will provide better pictures in dimly lit rooms or at nightfall.
- The focus range is 50 cm (Wide)/1.2 m (Tele) to 5 m.
- We recommend using a tripod and the Self-Timer for taking pictures.
- When the camera is set to [STABILIZER] and there is very little camera shake, or if [STABILIZER] is set to [OFF], shutter speed may slow down up to 8 seconds.
- The shutter may remain closed (max. about 8 sec.) after taking the picture because of signal processing. This is not a malfunction.
- Noise may become visible when you take pictures in dark places.
- The initial setting for [AF MODE] is [👤].
- [I.RESOLUTION] is fixed to [OFF].

**[NIGHT SCENERY]**

This allows you to take vivid pictures of the nightscape.

**Note**

- During motion picture recording, low light settings [📷] are used, which will provide better pictures in dimly lit rooms or at nightfall.
- The flash setting is fixed to [☉].
- The focus range is 5 m to ∞.
- We recommend using a tripod and the Self-Timer for taking pictures.
- When the camera is set to [STABILIZER] and there is very little camera shake, or if [STABILIZER] is set to [OFF], shutter speed may slow down up to 8 seconds.
- The shutter may remain closed (max. about 8 sec.) after taking the picture because of signal processing. This is not a malfunction.
- Noise may become visible when you take pictures in dark places.



**[FOOD]**

This mode allows you to take pictures of food with a natural hue without being affected by the ambient light in restaurants etc.



 **Note**

- The focus range is 1 cm (Wide)/30 cm (Tele) to ∞.

**[PARTY]**

Select this mode when you want to take pictures at a wedding reception or an indoor party etc. This allows you to take pictures of people and the background with near real-life brightness.

**■ Technique for Party Mode**

- **Open the flash.** (You can set to [] or [].)
- We recommend using a tripod and the Self-Timer for taking pictures.
- We recommend using the shortest possible focal length (wideangle) and being about 1.5 m from the subject when taking pictures.

 **Note**

- The initial setting for [AF MODE] is [].
- [I.RESOLUTION] is fixed to [OFF].

**[CANDLE LIGHT]**

This mode allows you to take pictures with a candle-lit atmosphere.

**■ Technique for Candle Light Mode**

- This is more effective when taking pictures without using the flash.

 **Note**

- The focus range is 1 cm (Wide)/30 cm (Tele) to ∞.
- We recommend using a tripod and the Self-Timer for taking pictures.
- When the camera is set to [STABILIZER] and there is very little camera shake, or if [STABILIZER] is set to [OFF], shutter speed may slow down up to 1 second.
- The initial setting for [AF MODE] is [].

## [BABY1]/[BABY2]

This takes pictures of a baby with a healthy complexion. When you use the flash, the light from it is weaker than usual.

It is possible to set different birthdays and names for [BABY1] and [BABY2]. You can select to have these appear at the time of playback, or have them stamped on the recorded image using [TEXT STAMP] (P164).

### ■ Birthday/Name setting

- 1 Press **▲/▼** to select [AGE] or [NAME] and then press **▶**.
- 2 Press **▲/▼** to select [SET] and then press [MENU/SET].
- 3 Enter the birthday or name.

Birthday: **◀/▶**: Select the items (year/month/day).

**▲/▼**: Setting.

[MENU/SET]: Exit.

Name: For details on how to enter characters, refer to "Entering Text" on P153.

- When the birthday or name is set, [AGE] or [NAME] is automatically set to [ON].
- If [ON] is selected when the birthday or name has not been registered, the setting screen appears automatically.

- 4 Press [MENU/SET] to finish.

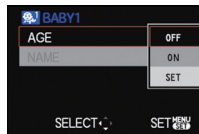

### ■ To cancel [AGE] and [NAME]

Select the [OFF] setting in step **2** of the "Birthday/Name setting" procedure.



#### Note

- During motion picture recording, settings for [PORTRAIT] are used.
- If [AGE] or [NAME] is set to [OFF] even when the birthday or name has been set, the age or name will not be displayed. Before taking pictures, set [AGE] or [NAME] to [ON].
- The focus range is 1 cm (Wide)/30 cm (Tele) to ∞.
- When the camera is set to [STABILIZER] and there is very little camera shake, or if [STABILIZER] is set to [OFF], shutter speed may slow down up to 1 second.
- Intelligent ISO sensitivity control is activated, and maximum ISO sensitivity level becomes [ISO1600].
- If the camera is turned on with [BABY1]/[BABY2] set, the age and name are displayed at the lower left of the screen for about 5 seconds, along with the current date and time.
- If the age is not properly displayed, check the clock and birthday settings.
- If the [QUALITY] is set to [RAW], [RAW] or [RAW] and pictures are taken, the name is not registered on the pictures.
- The birthday setting and name setting can be reset with [RESET].
- The initial setting for [AF MODE] is [AF].
- [I.RESOLUTION] is fixed to [OFF].

**[PET]**

Select this mode when you want to take pictures of a pet such as a dog or a cat. You can set your pet's birthday and name. You can select to have these appear at the time of playback, or have them stamped on the recorded image using [TEXT STAMP] (P164). For information about [AGE] or [NAME], refer to [BABY1]/[BABY2] on P98.

**Note**

- It will be a normal motion picture recording during the motion picture recording.
- The initial setting for the AF Assist Lamp is [OFF].
- The initial setting for [AF MODE] is [AF-ON].
- [i.RESOLUTION] is fixed to [STANDARD].
- Refer to [BABY1]/[BABY2] for other information about this mode.

**[SUNSET]**

Select this mode when you want to take pictures of a sunset view. This allows you to take vivid pictures of the red color of the sun.

**Note**

- The flash setting is fixed to [ON].

**[HIGH SENS.]**

This mode minimizes the unsharp rendition of moving subjects, and enables you to take pictures of them in dimly lit rooms. (Select this for high-sensitivity processing. The sensitivity automatically switches to between [ISO1600] and [ISO12800].)

- 2.5M (1:1), 3M (4:3), 2.5M (3:2) or 2M (16:9) is selected as the resolution.

**Note**

- [i.ZOOM] is fixed to [OFF].
- [QUALITY] is automatically fixed to [FINE].
- You can take pictures suitable for 4"×6"/10×15 cm printing.
- The focus range is 1 cm (Wide)/30 cm (Tele) to ∞.

**[HI-SPEED BURST]**

This is a convenient mode for shooting rapid movement or a decisive moment.

### ■ Setting the speed priority or image priority

**1** Press **▲/▼** to select **[SPEED PRIORITY]** or **[IMAGE PRIORITY]** and then press **[MENU/SET]** to set.

**2** Take pictures.

- Still pictures are taken continuously while the shutter button is pressed fully.
- 2.5M (1:1), 3M (4:3), 2.5M (3:2) or 2M (16:9) is selected as the resolution.

<b>Maximum frame rate/ image frequency</b>	approx. 10 pictures/second (Speed priority) approx. 6.5 pictures/second (Image priority)
<b>Number of recordable pictures</b>	approx. 15 to 100

- The frame rate changes according to the recording conditions.
- The number of serially recordable images is limited by the picture-taking conditions and the type and/or status of the card used.
- The number of serially recordable images increases immediately after formatting.

### Note

- It will be a normal motion picture recording during the motion picture recording.
- The flash setting is fixed to **[☺]**.
- [i.ZOOM] is fixed to [OFF].
- [QUALITY] is automatically fixed to **[.L.]**.
- You can take pictures suitable for 4"×6"/10×15 cm printing.
- The focus range is 1 cm (Wide)/30 cm (Tele) to ∞.
- The focus, zoom, exposure, White Balance, shutter speed and ISO sensitivity are fixed to the settings for the first picture.
- The ISO sensitivity is automatically adjusted. Note, however, that the ISO sensitivity is set high to achieve a high shutter speed.
- Depending on the operating conditions, it may take time to take the next picture if you repeat taking a picture.

**[FLASH BURST]**

Still pictures are taken continuously with flash. It is convenient to take continuous still pictures in dark places.

- Still pictures are taken continuously while the shutter button is pressed fully.
- 2.5M (1:1), 3M (4:3), 2.5M (3:2) or 2M (16:9) is selected as the resolution.

<b>Number of recordable pictures</b>	max. 5 pictures
--------------------------------------	-----------------

- The frame rate changes according to the recording conditions.

 **Note**

- **It will be a normal motion picture recording during the motion picture recording.**
- [I.RESOLUTION] is fixed to [OFF].
- [i.ZOOM] is fixed to [OFF].
- [QUALITY] is automatically fixed to [•••].
- You can take pictures suitable for 4"×6"/10×15 cm printing.
- The focus range is 1 cm (Wide)/30 cm (Tele) to ∞.
- The focus, zoom, exposure, shutter speed, ISO sensitivity, and flash level are fixed to the settings for the first picture.
- Intelligent ISO sensitivity control is activated, and maximum ISO sensitivity level becomes [ISO3200].
- See the Note on [P72](#) when using the flash.

## [STARRY SKY]

This allows you to take vivid pictures of a starry sky or a dark subject.

### ■ Setting the shutter speed

Select a shutter speed of [15 SEC.], [30 SEC.] or [60 SEC.].

#### 1 Press ▲/▼ to select the number of seconds and then press [MENU/SET].

- It is also possible to change the number of seconds using the Quick Menu. (P30)

#### 2 Take pictures.

- Press the shutter button fully to display the countdown screen. Do not move the camera after this screen is displayed. When countdown finishes, [PLEASE WAIT...] is displayed for the same length of time as the set shutter speed for signal processing.
- Press [MENU/SET] to stop taking the picture while the countdown screen is displayed.



### ■ Technique for Starry Sky Mode

- The shutter opens for 15, 30 or 60 seconds. Be sure to use a tripod. We also recommend taking pictures with the Self-Timer.

#### Note

- During motion picture recording, low light settings [ ] are used, which will provide better pictures in dimly lit rooms or at nightfall.
- The flash setting is fixed to [ ].
- The Optical Image Stabilizer function is fixed to [OFF].
- ISO sensitivity is fixed to [ISO80].
- [I.RESOLUTION] is fixed to [OFF].

## [FIREWORKS]

This mode allows you to take beautiful pictures of fireworks exploding in the night sky.

### ■ Technique for Fireworks Mode

- Since the shutter speed becomes slower, we recommend using a tripod.

#### Note

- It will be a normal motion picture recording during the motion picture recording.
- The flash setting is fixed to [ ].
- This mode is most effective when the subject is 10 m or more away.
- The shutter speed becomes the following.
  - When [OFF] is set on the Optical Image Stabilizer function: 2 seconds
  - When [AUTO], [MODE1] or [MODE2] is set on the Optical Image Stabilizer function: 1/4 second or 2 seconds (The shutter speed becomes 2 seconds only when the camera has determined that there is very little camera shake such as when using a tripod etc.)
  - You can change the shutter speed by compensating for the exposure.
- The AF area is not displayed.
- ISO sensitivity is fixed to [ISO80].
- [I.RESOLUTION] is fixed to [OFF].

## [BEACH]

This allows you to take even more vivid pictures of the blue color of the sea, sky etc. It also prevents underexposure of people under strong sunlight.

### Note

- The initial setting for [AF MODE] is [].
- Do not touch the camera with wet hands.
- Sand or seawater will cause the camera to malfunction. Make sure that sand or seawater does not get into the lens or the terminals.

## [SNOW]

This allows you to take pictures that show the snow as white as possible at a ski resort or a snow-covered mountain.

## [AERIAL PHOTO]

This mode allows you to take pictures through an airplane window.

### ■ Technique for Aerial Photo Mode

- We recommend using this technique if it is difficult to focus when taking pictures of clouds etc. Aim the camera at something with high contrast, press the shutter button halfway to fix the focus and then aim the camera at the subject and press the shutter button fully to take the picture.

### Note

- **The flash setting is fixed to [].**
- The focus range is 5 m to  $\infty$ .
- **Turn the camera off when taking off or landing.**
- **When using the camera, follow all instructions from the cabin crew.**
- Be careful about the reflection from the window.

[REC] Mode: **A P A S M C1 C2 SCN**

## Recording Motion Pictures

You can record high definition motion pictures compatible either with the AVCHD format or Motion JPEG.

Audio will be recorded in monaural.

### 1 Select the desired mode with the Mode dial.

#### ■ Modes that can be recorded for motion picture

Item	Settings/Note
<b>A</b> Snapshot Mode	The camera will set the most appropriate settings to match the subject and the recording conditions, so you can leave the settings to the camera and take motion pictures easily.
<b>P/A/S/M</b> Mode	Record motion pictures by automatically setting aperture and shutter speed.
<b>C1/C2</b> Creative Motion Picture Mode	Record motion pictures by manually setting aperture and shutter speed. (P111)
<b>C1/C2</b> Custom Mode	Record motion pictures with selected Custom Mode settings.
<b>SCN</b> Scene Mode	Scene motion picture
<b>My Color</b> Mode	Record motion pictures in My Color Mode setting.



#### Note

- It will be recorded in following categories for certain scene modes.

Selected Scene Mode	Scene Mode while recording motion pictures
[BABY1]/[BABY2]	Portrait Mode
[NIGHT PORTRAIT], [NIGHT SCENERY], [STARRY SKY]	Low Light Mode
[PANORAMA ASSIST], [SPORTS], [PET], [HI-SPEED BURST], [FLASH BURST], [FIREWORKS]	Normal motion picture

- A motion picture recording matching each scene will be performed for the ones not listed above. (P92 to 103)



## 2 Start recording by pressing the motion picture button.

- (A) Available recording time
- (B) Elapsed recording time

- Motion pictures will be recorded in the aspect ratio set in [REC QUALITY] regardless of the position of the aspect ratio selector switch.
- Release the motion picture button right after you press it.
- The audio is also recorded simultaneously from the built-in microphone on the camera. (Motion pictures cannot be recorded without audio.)
- The recording state indicator (red) © will flash while recording motion pictures.
- The screen will become dark momentarily, and recording will start after adjusting the display.
- Focus can be achieved during recording by pressing ▲ (FOCUS).
- Focus can be set manually when [MF] is displaying. (P84)

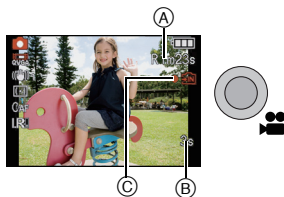

## 3 Stop the recording by pressing the motion picture button again.

- Sound will go off when pressing the motion picture button indicating start/stop of motion picture recording. Sound volume can be set in [BEEP LEVEL] (P31).
- If the internal memory or the card becomes full during recording, the process will be stopped automatically.

### ■ About focusing

When [CONTINUOUS AF] (P152) is set to [ON], and you focus on a subject, the camera will maintain focus on that subject. To fix the focus position when beginning to record a motion picture, set to [OFF].

**Note**

- The screen will change as following when the motion picture button is pressed in steps **2** and **3**.

- (A) Still picture recording screen\*1
- (B) Motion Picture Mode setting\*2
- (C) Motion picture recording screen
- (D) Still Picture Mode setting\*3

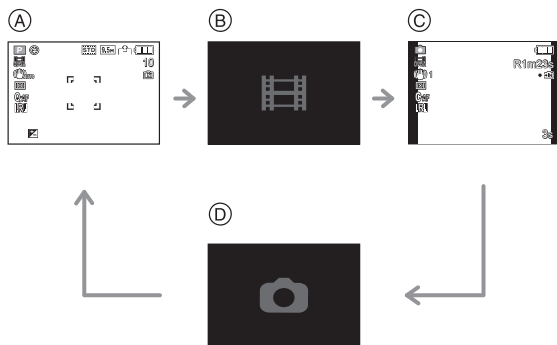

\*1 Set [REMAINING DISP.] (P33) to [ ]:☺ to display the available recording time before recording motion pictures.

\*2 The screen that is displayed during Motion Picture Mode setting is different depending on the setting of the [REC MODE].

\*3 [ ] will not be displayed in the Creative Motion Picture Mode.

- Refer to P151 for the [MOTION PICTURE] Mode menu.
- The flash setting is fixed to [ ].
- Refer to P229 for information about the available recording time.
- The available recording time displayed on the screen may not decrease regularly.
- Depending on the type of the card, the card access indication may appear for a while after recording motion pictures. This is not a malfunction.
- The operational sound of the zoom or button operation may be recorded when it is operated during the recording of a motion picture.
- When recording motion pictures with the lens cap string attached, the sound of the lens cap string brushing against the camera may be recorded.
- The screen may be blacked out momentarily, or the camera may record noise due to static electricity or electromagnetic waves etc. depending on the environment of the motion picture recording.
- When operating the zoom in recording motion pictures, it may take time to come into focus.
- If the Extended Optical Zoom was used before pressing the motion picture button, recordable area will be changed drastically since these settings are canceled.
- Even if the aspect ratio setting is the same in still and motion pictures, the angle of view may change at the start of the motion picture recording. When [ ]:REC AREA (P33) is set to [ON], angle of view during motion picture recording is displayed.

(A): (Example image)

When [REC QUALITY] is set to [AVCHD Lite] (16:9).

(B): This section is not recorded in motion pictures.

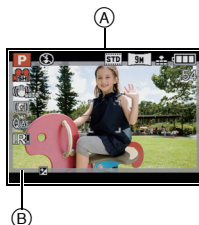





- [STABILIZER] (P146) is fixed to [MODE1] when recording motion pictures.
- When recording motion pictures, the following functions cannot be used.
  - [AF-ON] and [AF-ON] in [AF MODE] (It will switch to [AF-ON]).
  - Direction Detection function
  - Extended Optical Zoom
  - [FACE RECOG.]
  - [STEP ZOOM]
- It is recommended to use a fully charged battery when recording motion pictures.
- Zoom speed may be slower than normal.

### When set to Snapshot Mode

- When Snapshot Mode is selected in step **1** on page 104, motion picture recording matching to the subject or recording situation can be performed.

#### ■ Scene Detection

When the camera identifies the optimum scene, the icon of the scene concerned is displayed in blue for 2 seconds, after which its color changes to the usual red.

<b>A</b> →	 [i- PORTRAIT]
	 [i- SCENERY]
	 [i- LOW LIGHT]
	 [i- MACRO]

- [**A**] is set if none of the scenes are applicable, and the standard settings are set.
- When [**A**] is selected, the camera automatically detects a person's face, and it will adjust the focus and exposure. (**Face Detection**) (P135)

#### Note

- Refer to P52 for settings in Snapshot Mode.
- Due to conditions such as the ones below, a different scene may be identified for the same subject.
  - Subject conditions: When the face is bright or dark, the size of the subject, the color of the subject, the distance to the subject, the contrast of the subject, when the subject is moving
  - Recording conditions: Sunset, sunrise, under low brightness conditions, when the camera is shaken, when zoom is used
- To take pictures in an intended scene, it is recommended that you take pictures in the appropriate Recording Mode.

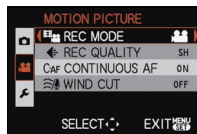

## Changing [REC MODE] and [REC QUALITY]

- 1** Select [REC MODE] from the [MOTION PICTURE] Mode menu, and press **▶**. (P28)



- 2** Press **▲/▼** to select the item and then press [MENU/SET].



Recording format	Features
 [AVCHD Lite]	<ul style="list-style-type: none"> <li>• Select this format to record HD (high definition) video for playback on your HDTV using an HDMI connection.</li> <li>• It can be played back as is by inserting the card into a device compatible with AVCHD. Refer to the instructions of the device used for details on compatibility.</li> <li>• Use a card with SD Speed Class* with "Class 4" or higher.</li> </ul>
 [MOTION JPEG]	<ul style="list-style-type: none"> <li>• Select this format to record standard definition video for playback on your PC. It can be recorded using less storage when there is not much space left on the memory card or when you want to attach the motion picture to an e-mail.</li> <li>• Use a card with SD Speed Class* with "Class 6" or higher.</li> </ul>

\*The SD Speed Class Rating is the speed standard for successive writes.



- 3** Press **▲/▼** to select [REC QUALITY] and then press **▶**.



4

Press ▲/▼ to select the item and then press [MENU/SET].

When [AVCHD Lite] is selected in step 2

	Item	Quality (bit rate) <sup>*1</sup>	fps	Aspect ratio
High quality ↓ ↑ Longer time	 ([SH])	1280×720 pixels Approx. 17 Mbps <sup>*2</sup>	60p <sup>*3</sup> / 50p <sup>*4</sup> (Sensor output is 30 <sup>*3</sup> / 25 <sup>*4</sup> fps)	16:9
	 ([H])	1280×720 pixels Approx. 13 Mbps <sup>*2</sup>		
	 ([L])	1280×720 pixels Approx. 9 Mbps <sup>*2</sup>		

\*1 What is bit rate

This is the volume of data for a definite period of time, and the quality becomes higher when the number gets bigger. This camera is using the “VBR” recording method. “VBR” is an abbreviation of “Variable Bit Rate”, and the bit rate (volume of data for definite period of time) is changed automatically depending on the subject to record. Therefore, the recording time is shortened when a subject with fast movement is recorded.





\*2 What is Mbps

This is an abbreviation of “Megabit Per Second”, and it represents the speed of transmission.



\*3 With camera models 18 151 / 18 152

\*4 With camera model 18 150

When [MOTION JPEG] is selected in step 2

	Item	Resolution	fps	Aspect ratio
High quality ↓ ↑ Longer time	 ([HD])	1280×720 pixels	30	16:9
	 <sup>*5</sup> ([WVGA])	848×480 pixels		
	 ([VGA])	640×480 pixels		
	 ([QVGA])	320×240 pixels		4:3

\*5 This item cannot be set in the Snapshot Mode.

- With the [AVCHD Lite] or  for [MOTION JPEG], high quality motion picture can be enjoyed on the TV by using the HDMI mini cable (available as accessory, see P7). For details, see “Playing back pictures on a TV with an HDMI socket” on P178.
- It cannot be recorded to internal memory except for the .

5

Press [MENU/SET] to close the menu.

- You can also press the shutter button halfway to close the menu.

 **Note**

- The motion picture recording may stop in the middle when any of the following cards are used.
  - Cards on which recording and deleting have been repeated many times
  - Cards which have been formatted using a PC or other equipmentBefore taking pictures, format (P40) the card in this camera. Because formatting will delete all data recorded on the card, save important data beforehand on the computer.
- You may not be able to record for a short while after turning the power [ON] when using a large capacity card.
- **Motion pictures recorded in [AVCHD Lite] or [MOTION JPEG] may be played back with poor picture or sound quality or playback may not be possible even when played back with equipment compatible with these formats. Also, the recording information may not be displayed properly. In this case, use the camera.**
- Motion picture recorded in [AVCHD Lite] does not comply with the “DCF/Exif”, so some information will not display while playback.
- **Sound from motion pictures (When [REC MODE] is set to [MOTION JPEG]) recorded by this camera cannot be played back by Leica digital cameras launched before July 2008.**

[REC] Mode: 

## Recording Motion Pictures with Manual Settings

It is possible to manually change the aperture and shutter speed and record motion pictures. Switching the [EXPOSURE MODE] allows you to use settings such as those when the mode dial is switched to **[P]**, **[A]**, **[S]** and **[M]**.

**1** Set the mode dial to **[M]**.

**2** Press **▲/▼** to select the exposure mode and then press **[MENU/SET]**.

- It can be selected from the Quick Menu (P30).



**3** Rotate the rear dial to change the settings.

- Items that can be set will switch every time the rear dial is pressed.



[EXPOSURE MODE]	Items that can be set	
<b>P (Program Mode)</b>	Program Shift	Exposure Compensation*
<b>A (Aperture-Priority Mode)</b>	Aperture*	Exposure Compensation*
<b>S (Shutter-Priority Mode)</b>	Shutter speed*	Exposure Compensation*
<b>M (Manual Exposure Mode)</b>	Shutter speed*	Aperture*

\*You can change the settings even during motion picture recording. However please note that operating sounds may be recorded.

- When the focus selector switch is at [MF], you can also set Manual Focus using the rear dial or the cursor button. (P84)

**4** Start recording by pressing the motion picture button.

## 5 Stop the recording by pressing the motion picture button again.

- If the internal memory or the card becomes full in the middle of recording, the camera stops recording automatically.
- You can also start/stop motion picture recording by pressing the shutter button.
- Sound will go off when pressing the motion picture button or shutter button indicating motion picture recording start/stop. Sound volume can be set in [BEEP LEVEL] (P31).

### ■ Setting the aperture value and shutter speed for each [EXPOSURE MODE]

[EXPOSURE MODE]	Aperture value	Shutter speed (Sec.)
P	—	—
A	F2.0 to F11 (Wide)/F3.3 to F18 (Tele)	
S	—	1/30 to 1/20000s
M	F2.0 to F11 (Wide)/F3.3 to F18 (Tele)	1/30 to 1/20000s (When using Manual Focus, the shutter speed can be set from 1/8 to 1/20000s.)

#### Note

##### • Aperture value

- Set the aperture value to a higher number when you want a larger in-focus area (in front of and behind the main subject), to a lower number for a smaller in-focus area.

##### • Shutter speed

- When you want to take a sharp picture of a fast moving subject, set a fast shutter speed.
- When you want to create a trailing effect, set to a slower shutter speed.
- Manually setting a higher shutter speed may increase the noise on-screen due to the higher sensitivity.
- When recording under lighting such as fluorescent lighting, mercury lighting and sodium lighting, the coloring and brightness of the screen may change.
- Refer to "Recording Motion Pictures" on P104 for other settings and operations for recording motion pictures.
- **Sound from motion pictures (When [REC MODE] is set to [MOTION JPEG]) recorded by this camera cannot be played back by Leica digital cameras launched before July 2008.**



[REC] Mode: **A P A S M C1 C2 SCN** 

## Using the Face Recognition Function

Face Recognition is a function which finds a face resembling a registered face and prioritizes focus and exposure automatically. Even if the person is located towards the back or on the end of a line in a group photo, the camera can still take a clear picture.

**[FACE RECOG.] is initially set to [OFF] on the camera.**

**[FACE RECOG.] will turn [ON] automatically when the face image is registered.**

- The following functions will also work with the Face Recognition function.

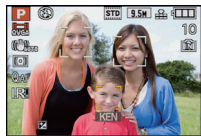

### In Recording Mode

- Display of corresponding name when camera detects a registered face\*<sup>1</sup> (if name has been set for the registered face)
- The camera will remember a face that has been photographed many times and display the registration screen automatically (if [AUTO REGISTRATION] is set to [ON])

### In Playback Mode

- Display of name and age (if information has been registered)
- Selective playback of pictures chosen from pictures registered with Face Recognition ([CATEGORY PLAY] (P157))

- \*1 Names of up to 3 people are displayed. Precedence for the names displayed when taking pictures is determined according to the order of registration.

### Note

- [AF MODE] is fixed to [AF].
- During Continuous Mode, [FACE RECOG.] picture information can be attached to only the first picture.
- After pressing the shutter halfway down, a different person's picture information may be added when the camera is turned to a different subject to photograph.
- [FACE RECOG.] can be used in the following Scene Modes.
  - [PORTRAIT]/[SOFT SKIN]/[SELF PORTRAIT]<sup>\*2</sup>/[SCENERY]/[SPORTS]/[NIGHT PORTRAIT]/[PARTY]/[CANDLE LIGHT]/[BABY1]/[BABY2]/[PET]/[SUNSET]/[HIGH SENS.]/[BEACH]/[SNOW]
  - \*2 [AUTO REGISTRATION] is fixed to [OFF].
- [FACE RECOG.] will not work during Manual Focus.
- [FACE RECOG.] will find a face similar to the registered face, and does not guarantee secure recognition of a person.
- Face Recognition may take more time to select and recognize distinctive facial features than regular Face Detection.
- Even when Face Recognition information has been registered, pictures taken with [NAME] set to [OFF] will not be categorized by Face Recognition in [CATEGORY PLAY].
- **Even when Face Recognition information is changed (P117), Face Recognition information for the pictures already taken will not be changed.**
  - For instance, if the name is changed, pictures recorded before the change will not be categorized by Face Recognition in [CATEGORY PLAY].
- To change the name information of the pictures taken, perform the [REPLACE] in [FACE REC EDIT] (P175).

## Face Settings

You can register information such as names and birthdays for face images of up to 6 people.

Registration can be facilitated by taking multiple face images of each person. (up to 3 pictures/registration)

### ■ Point of recording when registering the face images

- Face front with eyes open and mouth closed, making sure the outline of the face, the eyes, or the eyebrows are not covered with the hair when registering.
- Make sure there is no extreme shading on the face when registering. (Flash will not flash during registration.)

(Good example for registering)



### ■ When it is not recognising during recording

- Register the face of same person indoors and outdoors, or with different expressions or angles. (P117)
- Additionally register at the location of recording.
- Changing the [SENSITIVITY] setting. (P117)
- When a person who is registered is not recognized, correct by re-registering.

### Example of faces that are hard to recognize

Face Recognition may not be possible or may not recognize faces correctly even for registered faces in the following instances, depending on the facial expression and environment.

- Hair is covering the eyes or the eyebrows (A)
- The face is dark/the light is at an angle (B)
- The face is facing on angle or sideways
- The face is facing upward/downward
- The eyes are closed
- When the face is extremely bright or dark
- Hidden by sunglasses, glasses reflecting light, hair, hat, etc.
- When the face appears small on the screen
- The entire face is not in the screen
- When distinctive facial features have changed with age
- When parents and children or siblings closely resemble one another
- Facial expression is very different
- When there is little contrast on the faces
- When there is rapid movement
- When the camera is shaking
- When Digital Zoom is used

(A)



(B)



## Registering face image of new person

**1** Select [FACE RECOG.] on the [REC] Mode menu and then press **▶**.  
(P28)

**2** Press **▲/▼** to select [MEMORY] and then press [MENU/SET].

**3** Press **▲/▼/◀/▶** to select the Face Recognition frame that is not registered, and then press [MENU/SET].

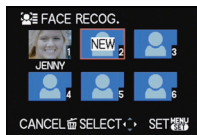

**4** Take the picture adjusting the face with the guide.

- The faces of subjects other than people (pets, etc.) cannot be registered.
- When recognition fails, a message will appear and the display will return to the recording screen. In this case, try taking the picture again.

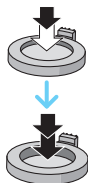

**5** Press **▲** to select [YES] and then press [MENU/SET].

## 6

**Select item to edit with ▲/▼, and then press ►.**

- You can register up to 3 face images.

Item	Description of settings
[NAME]	It is possible to register names. <b>1 Press ▼ to select [SET] and then press [MENU/SET].</b> <b>2 Enter the name.</b> <ul style="list-style-type: none"> <li>• For details on how to enter characters, refer to “Entering Text” section on P153.</li> </ul>
[AGE]	It is possible to register the birthday. <b>1 Press ▼ to select [SET] and then press [MENU/SET].</b> <b>2 Press ◀/▶ to select the items (Year/Month/Day), and then press ▲/▼ to set and then press [MENU/SET].</b>
[FOCUS ICON]	Change the displayed focus icon when the subject is focused. <b>Press ▲/▼ to select the focus icon, and then press [MENU/SET].</b>
[ADD IMAGES]	To add additional face images. <b>(Add Images)</b> <b>1 Select the unregistered face recognition frame, and then press [MENU/SET].</b> <b>2 Perform steps 4 and 5 in “Registering face image of new person”.</b> <b>3 Press [🗑].</b>
	To delete one of the face images. <b>(Delete)</b> <b>1 Press ◀/▶ to select the face image to delete, and then press [MENU/SET].</b> <b>2 Press ▲ to select [YES] and then press [MENU/SET].</b> <b>3 Press [🗑].</b> <ul style="list-style-type: none"> <li>• If there is only one image registered, it cannot be deleted.</li> </ul>

## 7

**Press the shutter button halfway to close the menu.****■ About the information ⓘ**

- When [DISPLAY] is pressed on the recording screen described in step 4 on P115, an explanation appears for taking face images. (Press again to return to the recording screen.)

## Change or delete the information for a registered person

You can modify the pictures or information of an already registered person. You can also delete the information of the registered person.

- 1 Select [FACE RECOG.] from the [REC] Mode menu, and then press **▶**. (P28)
- 2 Press **▼** to select [MEMORY] and press [MENU/SET].
- 3 Press **▲/▼/◀/▶** to select the face image to edit or delete and then press [MENU/SET].
- 4 Press **▲/▼** to select the item and then press [MENU/SET].



Item	Description of settings
[INFO EDIT]	Changing the information of an already registered person. <b>Perform step 6 in “Registering face image of new person”.</b>
[PRIORITY]	The focus and exposure are preferentially adjusted for higher-priority faces. <b>Press ▲/▼/◀/▶ to select the priority and then press [MENU/SET].</b>
[DELETE]	Deleting information of a registered person. <b>Press ▲ to select [YES] and then press [MENU/SET].</b>

- 5 Press the shutter button halfway to close the menu.

## Setting Auto Registration/Sensitivity

Setting of Auto Registration and Sensitivity for Face Recognition can be done.

- 1 Select [FACE RECOG.] from the [REC] Mode menu, and then press **▶**. (P28)
- 2 Press **▼** to select [SET] and then press [MENU/SET].
- 3 Press **▲/▼** to select the item and then press **▶**.

Item	Description of settings
[AUTO REGISTRATION]	[OFF]/[ON] <ul style="list-style-type: none"> <li>• When the [AUTO REGISTRATION] is set to [ON], [FACE RECOG.] will be set to [ON] automatically.</li> <li>• For details, see “Auto Registration” on P118.</li> </ul>
[SENSITIVITY]	[HIGH]/[NORMAL]/[LOW] <ul style="list-style-type: none"> <li>• Select [HIGH] when recognition proves to be difficult. The likelihood of recognition increases, but so does the likelihood of mistaken recognition.</li> <li>• Select [LOW] when mistaken recognition happens frequently.</li> <li>• To return to the original settings, select [NORMAL].</li> </ul>

- 4 Press the shutter button halfway to close the menu.

## Auto Registration

When [AUTO REGISTRATION] is set to [ON], the registration screen will display automatically after taking a picture of a face that has a high number of appearances.

- Registration screen is displayed after approximately 3 pictures. (Except with [MULTI EXPO.], [BURST], [AUTO BRACKET], [ASPECT BRACKET], White Balance Bracket, [MULTI FILM] and [SELF PORTRAIT] in Scene Mode)
- It may be extremely hard to recognize only with [AUTO REGISTRATION], so register the face images with [FACE RECOG.] in the [REC] Mode menu beforehand.

### ■ Registering from the automatic registration screen

#### 1 Press **▲** to select [YES] and then press [MENU/SET].

- If there are no registered persons, proceed to step **3**.
- Selection screen is displayed again when [NO] is selected, and when [YES] is selected with **▲**, [AUTO REGISTRATION] will be set to [OFF].

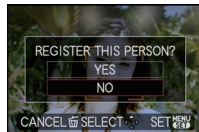

#### 2 Press **▲/▼** to select [NEW PERSON] or [ADDITIONAL IMAGE] and then press [MENU/SET].

Item	Description of settings
[NEW PERSON]	• A list of registered people is displayed when there are 6 people already registered. Select the person to be replaced.
[ADDITIONAL IMAGE]	To additionally register a face image for a registered person. <b>Press <b>▲/▼/◀/▶</b> to select the person to whom you wish add the picture, and then press [MENU/SET].</b> • If 3 images have already been registered, the picture replacement screen will appear. In this case, select the picture you wish to replace.

- After additionally registering or changing a face image, the screen returns automatically to the recording screen.

#### 3 Perform the operation in Step 6 and following in “Registering face image of new person”.

#### Note

- If the registration screen will not display, it may display easier by recording in the same conditions or with the same expressions.
- If a face is not recognized even though it is registered, it will make the recognition easier by registering the person again using the [FACE RECOG.] in the [REC] Mode menu in that environment.
- If the registration screen is displayed for a person that is already registered, it will make the recognition easier by additionally registering.
- It may make recognition harder when a picture recorded with flash is registered.

[REC] Mode: **A P A S M** **C1 C2** **SCN**

## Useful Functions at Travel Destinations

### Recording which Day of the Vacation and the Location of the Vacation

For details on the [SETUP] menu settings, refer to P28.

If you set the departure date and the location of the vacation in advance, the number of days that have passed since the departure date (which day of the vacation it is) is recorded when you take the picture. You can display the number of days that have passed when playing back the pictures and stamp it on the recorded pictures with [TEXT STAMP] (P164).

• Select [CLOCK SET] to set the current date and time in advance. (P25)

**1** Select [TRAVEL DATE] from the [SETUP] menu, and then press **▶**.

**2** Press **▲** to select [TRAVEL SETUP] and then press **▶**.

**3** Press **▼** to select [SET] and then press [MENU/SET].

**4** Press **▲/▼/◀/▶** to set the departure date (year/month/day), and then press [MENU/SET].

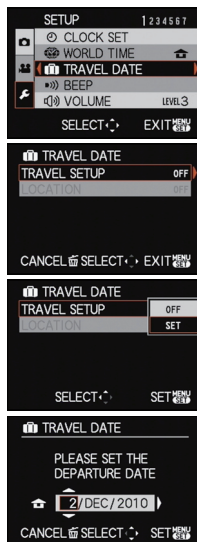

- 5** Press **▲/▼/◀/▶** to set the return date (year/month/day), and then press **[MENU/SET]**.
- If you do not want to set the return date, press **[MENU/SET]** while the date bar is displayed.

- 6** Press **▼** to select **[LOCATION]** and then press **▶**.

- 7** Press **▼** to select **[SET]** and then press **[MENU/SET]**.

- 8** Enter the location.

- For details on how to enter characters, refer to “Entering Text” on [P153](#).

- 9** Press **[MENU/SET]** twice to close the menu.

- 10** Take a picture.

- The number of days that have passed since the departure date is displayed for about 5 seconds if the camera is turned on etc. after setting the travel date or when the travel date is set.
- When the travel date is set,  appears on the lower right of the screen.

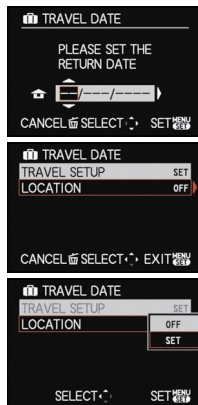



## ■ Canceling the travel date

The travel date is automatically canceled if the current date is after the return date. If you want to cancel the travel date before the end of the vacation, select [OFF] on the screen shown in step **3** or **7**, and then press [MENU/SET] twice. [LOCATION] also will be set to [OFF] automatically when the travel date is set to [OFF] in step **3**.

### Note

- The travel date is calculated using the date in the clock setting and the departure date you set. If you set [WORLD TIME] (P122) to the [DESTINATION], the travel date is calculated using the date of the travel destination.
- The travel date setting is memorized even if the camera is turned off.
- If [TRAVEL DATE] is set to [OFF], the number of days that have passed since the departure date will not be recorded. Even if [TRAVEL DATE] is set to [SET] after taking the pictures, which day of the vacation you took them is not displayed.
- For the date before the departure date, [-] (minus) is displayed in orange and the day of the vacation is not recorded.
- If the travel date is displayed as [-] (minus) in white, there is a time difference that involves date change between the [HOME] and [DESTINATION]. (It will be recorded)
- [TRAVEL DATE] cannot be set for motion pictures recorded with [AVCHD Lite].
- [LOCATION] cannot be recorded in the following cases.
  - When [QUALITY] is set to [ $\frac{\text{RAW}}{\text{MPEG}}$ ], [ $\frac{\text{RAW}}{\text{H.264}}$ ] or [RAW]
  - When recording motion pictures
- [TRAVEL DATE] cannot be set in the Snapshot Mode. Setting of other recording mode will be reflected.

## Recording Dates/Times at Overseas Travel Destinations (World Time)

For details on the [SETUP] menu settings, refer to P28.

You can display the local times at the travel destinations and record them on the pictures you take.

- Select [CLOCK SET] to set the current date and time in advance. (P25)

### 1 Select [WORLD TIME] from the [SETUP] menu, and then press **▶**.

- When first using the camera after purchasing it, the [PLEASE SET THE HOME AREA] message appears. Press [MENU/SET], and set the home area on the screen in step 3.

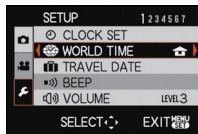

### 2 Press **▼** to select [HOME], and then press [MENU/SET].

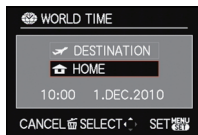

### 3 Press **◀/▶** to select the home area, and then press [MENU/SET].

- (A) Current time
- (B) Time difference from GMT (Greenwich Mean Time)
- If daylight saving time [☀️] is used at the home area, press **▲**. Press **▲** again to return to the original time.
- The daylight saving time setting for the home area does not advance the current time. Advance the clock setting by one hour.



- 4** Press **▲** to select [DESTINATION] and then press [MENU/SET] to set.

Ⓒ Depending on the setting, the time at the travel destination area or the home area is displayed.

- 5** Press **◀/▶** to select the area the travel destination is in and then press [MENU/SET] to set.

Ⓓ Current time of the destination area

Ⓔ Time difference

- If daylight saving time [**☀**Ⓜ] is used at the travel destination, press **▲**. (The time advances by one hour.) Press **▲** again to return to the original time.

- 6** Press [MENU/SET] to close the menu.

**Note**

- Return the setting to [HOME] when the vacation is finished by performing steps **1**, **2** and **3**.
- If [HOME] is already set, change only the travel destination, and use.
- If you cannot find the travel destination in the areas displayed on the screen, set by the time difference from the home area.















## Using the [REC] Mode Menu

### [FILM MODE]

For details on [REC] Mode menu settings, refer to P28.

Just as each type of film for film cameras has its own color tone and contrast characteristics, Film Mode allows you to select up to 9 different “digital films”, color tones, in the same way as you would select different films for film cameras. Select different settings in Film Mode to match the photo look you wish to achieve.

Applicable modes: **P A S M**   

 [STANDARD]	This is the standard setting.
 [DYNAMIC]	The saturation and contrast of the stored colors are increased.
 [NATURE]	Brighter red, green and blue. Enhanced beauty of nature.
 [SMOOTH]	The contrast is lowered for smoother and clearer color.
 [VIBRANT]	Higher saturation and contrast than dynamic.
 [NOSTALGIC]	Lower saturation and contrast. Reflecting passage of time.
 [STANDARD] (B&W)	This is the standard setting.
 [DYNAMIC] (B&W)	The contrast is increased.
 [SMOOTH] (B&W)	Smooths the picture without losing the skin texture.
 [MY FILM 1]  [MY FILM 2]	The saved setting is used.
 [MULTI FILM]	One press of the shutter button automatically records the picture to a selected number of films (up to a maximum of three films).

#### Note

- You cannot adjust [SATURATION] in the black and white settings in Film Mode.

**1 Press ◀/▶ to select a film and then press [MENU/SET].**

- When you press [DISPLAY] on the screen shown right, explanations about each Film Mode are displayed. (When you press [DISPLAY] again, the screen returns to the previous screen.)

**2 Press [MENU/SET] to close the menu.**

- You can also press the shutter button halfway to close the menu.

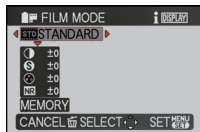
**■ Adjusting each Film Mode to the desired setting****1 Press ◀/▶ to select a film.****2 Press ▲/▼ to select an item and ◀/▶ to adjust.**

- Registered settings are memorized even if the camera is turned off.

**3 Press ▲/▼ to select the [MEMORY] and then press [MENU/SET].****4 Press ▲/▼ to select an item, and then press [MENU/SET].**

- You can register 2 settings. ([MY FILM 1] and [MY FILM 2]) (After registering, the Film Mode name that was registered previously is displayed.)
- [STANDARD] is registered in [MY FILM 1] and [STANDARD] (RAW) is registered in [MY FILM 2] at the time of purchase.

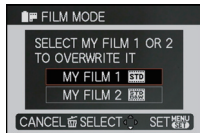

Item		Effect
[CONTRAST]	[+]	Increases the difference between the brightness and the darkness in the picture.
	[-]	Decreases the difference between the brightness and the darkness in the picture.
[SHARPNESS]	[+]	The picture is sharply defined.
	[-]	The picture is softly focused.
[SATURATION]	[+]	The colors in the picture become vivid.
	[-]	The colors in the picture become natural.
[NOISE REDUCTION]	[+]	The noise reduction effect is enhanced. Picture resolution may deteriorate slightly.
	[-]	The noise reduction effect is reduced. You can obtain pictures with higher resolution.

■ Select the film you would like to use with [MULTI FILM]

1 Press ◀/▶ to select [MULTI FILM] and then press ▼.

2 Select either [MULTI FILM 1], [MULTI FILM 2], or [MULTI FILM 3] with ▲/▼, select the film to be set for each with ◀/▶, and then press [MENU/SET].

- [OFF] can be selected only for [MULTI FILM 3].
- One press of the shutter button automatically records the picture to a selected number of films (up to a maximum of three films).

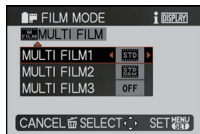

**Note**

- In Film Mode, the camera may do something equivalent to pull processing or push processing to create a picture with particular characteristics. The shutter speed may become very slow at this time.
- Noise may become visible when you take pictures in dark places. To avoid picture noise, we recommend setting [NOISE REDUCTION] towards [+ ] or setting the items except [NOISE REDUCTION] towards [- ] to take pictures.
- When [QUALITY] is set to [RAW], [RAW] or [RAW], [MULTI FILM] does not function.
- If you adjust a Film Mode, the Film Mode icon on the screen will turn orange.
- [MULTI FILM 1] is set to [STANDARD], [MULTI FILM 2] is set to [STANDARD] (B&W), and [MULTI FILM 3] is set to [OFF] at the time when this camera is purchased.
- The [MULTI FILM] setting is released when the power has been turned off (including Sleep Mode).
- [☀] is set for the flash when [MULTI FILM] is set.
- [AUTO BRACKET], [ASPECT BRACKET], [BURST] or White Balance Bracket will be disabled when the [MULTI FILM] is set.
- Motion pictures are recorded with the settings for the [MULTI FILM 1] setting.

**[RESOLUTION]**





For details on [REC] Mode menu settings, refer to P28.

Set the resolution. The higher the resolution, the finer the detail of the pictures will appear even when they are printed onto large sheets.





Applicable modes: **A P A S M C1 C2 SCN** 

■ When the aspect ratio is [1:1].





\* This mode is not available with Snapshot Mode.

<b>7.5M</b> (7.5M)	2736×2736 pixels
<b>5.5M</b> (5.5M  )*	2304×2304 pixels
<b>3.5M</b> (3.5M  )	1920×1920 pixels
<b>2.5M</b> (2.5M  )*	1536×1536 pixels
<b>0.2M</b> (0.2M  )	480×480 pixels

■ When the aspect ratio is [4:3].

<b>10M</b> (10M)	3648×2736 pixels
<b>7M</b> (7M  )*	3072×2304 pixels
<b>5M</b> (5M  )	2560×1920 pixels
<b>3M</b> (3M  )	2048×1536 pixels
<b>2M</b> (2M  )*	1600×1200 pixels
<b>0.3M</b> (0.3M  )	640×480 pixels

■ When the aspect ratio is [3:2].

<b>9.5M</b> (9.5M)	3776×2520 pixels
<b>6.5M</b> (6.5M  )*	3168×2112 pixels
<b>4.5M</b> (4.5M  )	2656×1768 pixels
<b>3M</b> (3M  )*	2112×1408 pixels
<b>2.5M</b> (2.5M  )	2048×1360 pixels
<b>0.3M</b> (0.3M  )	640×424 pixels

## ■ When the aspect ratio is [16:9].

9M (9M)	3968×2232 pixels
6M (6M <b>EZ</b> )*	3328×1872 pixels
4.5M (4.5M <b>EZ</b> )	2784×1568 pixels
2.5M (2.5M <b>EZ</b> )	2208×1248 pixels
2M (2M <b>EZ</b> )*	1920×1080 pixels
0.2M (0.2M <b>EZ</b> )	640×360 pixels

 **Note**

- “EZ” is an abbreviation of “Extended Optical Zoom”.
- A digital picture is made of numerous dots called pixels. The higher the numbers of pixels, the finer the picture will be when it is printed on a large piece of paper or displayed on a PC monitor.
- Ⓐ Many pixels (Fine)
  - Ⓑ Few pixels (Rough)
- \* These pictures are examples to show the effect.
- If you change the aspect ratio, set the resolution again.
- The Extended Optical Zoom does not work when in [HIGH SENS.], [HI-SPEED BURST] and [FLASH BURST] in Scene Mode so resolution for [**EZ**] is not displayed.
- You cannot set [RESOLUTION] when [QUALITY] is set to [RAW].
- Pictures may appear in mosaic depending on the subject and the recording conditions.
- Refer to [P222](#) for information about the number of recordable pictures.

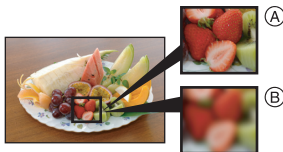







## [QUALITY]

For details on [REC] Mode menu settings, refer to P28.

Set the compression rate at which the pictures are to be stored.



Applicable modes: **P A S M C1 C2 SCN** 

- : Fine (when giving priority to the picture quality)
- : Standard (when using the standard picture quality and increasing the number of pictures to be recorded without changing the number of pixels)
- : RAW+Fine (In addition to the [RAW] settings, a fine-equivalent JPEG image is simultaneously created.)\*<sup>1</sup>
- : RAW+Standard (In addition to the [RAW] settings, a standard-equivalent JPEG image is simultaneously created.)\*<sup>1</sup>
- : RAW file (When the image is to be edited with a PC in high quality)\*<sup>2</sup>

\*1 If you delete a RAW file from the camera, the corresponding JPEG image will also be deleted.

\*2 It is fixed to maximum recordable pixels for each image aspect ratio.

 **Note**

- If a RAW picture is recorded with the internal memory, it will take time to write the picture data.
- Refer to P222 for information about the number of recordable pictures.
- You can enjoy more advanced picture editing if you use RAW files. You can save RAW files in a file format (JPEG, TIFF etc.) that can be displayed on your PC etc., develop them and edit them using the software available after registering on the Leica Camera AG homepage (see separate leaflet).
- [RAW] images are recorded with a smaller data volume than  or .
- [PRINT SET] and [FAVORITE] cannot be set to a picture taken by [RAW].

**[SENSITIVITY]**

For details on [REC] Mode menu settings, refer to P28.

This allows the sensitivity to light (ISO sensitivity) to be set. Setting to a higher number enables pictures to be taken even in dark places without the resulting pictures coming out dark.

Applicable modes: **P A S M**    

[AUTO]/[ISO]/[80]/[100]/[200]/[400]/[800]/[1600]/[3200]/[6400]/[12800]

 **Note**

- Refer to P75 for details.

**[ISO LIMIT SET]**

For details on [REC] Mode menu settings, refer to P28.

It will select optimal ISO sensitivity with set value as limit depending on the brightness of the subject.

Applicable modes: **P A S M**    

[AUTO]/[200]/[400]/[800]/[1600]/[3200]

 **Note**

- Setting items below will be selectable in Creative Motion Picture Mode.  
[AUTO]/[800]/[1600]/[3200]/[6400]
- The higher the value set for the ISO sensitivity, the more the effects of subject movement is reduced but the greater the amount of picture noise.
- It is possible to set when the [SENSITIVITY] is set to [AUTO] or [ISO].

**[ISO INCREMENTS]**

For details on [REC] Mode menu settings, refer to P28.

ISO sensitivity settings between [ISO80] and [ISO12800] are changed for every 1/3 EV.

Applicable modes: **P A S M**    

[1/3 EV]: [80]/[100]/[125]/[160]/[200]/[250]/[320]/[400]/[500]/[640]/[800]/[1000]/[1250]/[1600]/[2000]/[2500]/[3200]/[4000]/[5000]/[6400]/[8000]/[10000]/[12800]

[1 EV]: [80]/[100]/[200]/[400]/[800]/[1600]/[3200]/[6400]/[12800]

 **Note**









- When the setting is changed from [1/3 EV] to [1 EV], ISO sensitivity will be set to value closest to the value set during the [1/3 EV]. (Set value will not restore when the setting is changed back to [1/3 EV]. It will stay as the setting selected for [1 EV].)

**[WHITE BALANCE]**



For details on [REC] Mode menu settings, refer to P28.

In sunlight, under incandescent lights or in other such conditions where the color of white takes on a reddish or bluish tinge, this item adjusts to the color of white which is closest to what is seen by the eye in accordance with the light source.

Applicable modes: **P A S M**    **SCN** 

- [AWB]**: Automatic adjustment
- : When taking pictures outdoors under a clear sky
- : When taking pictures outdoors under a cloudy sky
- : When taking pictures outdoors in the shade
- : When taking pictures with the flash only
- : When taking pictures under incandescent lights
- /: When using the preset White Balance
- [K]: When using the preset color temperature setting

 **Note**

- The optimal White Balance will differ depending on the type of halogen lighting being recorded under so use [AWB],  or .
- The White Balance might not be adjusted for the subject where the flash does not reach when the flash is used.
- The White Balance setting is memorized even if the camera is turned off. (However, the White Balance setting for a Scene Mode returns to [AWB] when the Scene Mode is changed.)
- In the Scene Modes listed below, White Balance is fixed to [AWB].
  - [SCENERY]/[NIGHT PORTRAIT]/[NIGHT SCENERY]/[FOOD]/[PARTY]/[CANDLE LIGHT]/[SUNSET]/[FLASH BURST]/[STARRY SKY]/[FIREWORKS]/[BEACH]/[SNOW]/[AERIAL PHOTO]
- White Balance is fixed to [AWB] in following conditions.
  - In Snapshot Mode
  - [EXPRESSIVE], [RETRO], [PURE], [ELEGANT], [MONOCHROME], [SILHOUETTE], [FILM GRAIN] and [CUSTOM] in My Color Mode

**■ Setting the White Balance manually**

Set the White Balance value. Use to match the condition when taking photographs.

- 1 Select [] or [] and then press **▶**.
- 2 Aim the camera at a sheet of white paper etc., so that the frame in the center is filled by the white object only and then press **[MENU/SET]**.



- White Balance may not be set when the subject is too bright or too dark. Set the White Balance again after adjusting to appropriate brightness.

**■ Finely adjusting the White Balance []**

You can finely adjust the White Balance when you cannot acquire the desired hue by setting the White Balance.

- 1 Select **[WHITE BALANCE]** and then press **▶**.
  - Press **▶** again if [], [] or [] is selected.
- 2 Press **▲/▼/◀/▶** to adjust the White Balance and then press **[MENU/SET]**.

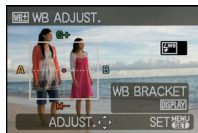

- ◀ : A (AMBER: ORANGE)
- ▶ : B (BLUE: BLUISH)
- ▲ : G+ (GREEN: GREENISH)
- ▼ : M- (MAGENTA: REDDISH)

**Note**

- If you finely adjust the White Balance to A (amber), the White Balance icon on the screen will change to orange. If you finely adjust the White Balance to B (blue), the White Balance icon on the screen will change to blue.
- If you finely adjust the White Balance to G+ (green) or M- (magenta), [+ ] (green) or [- ] (magenta) appears beside the White Balance icon on the screen.
- Select the center point if you are not finely adjusting the White Balance.
- The White Balance fine adjustment setting is reflected in the picture when using the flash.
- You can finely adjust the White Balance independently for each White Balance item.
- The White Balance fine adjustment setting is memorized even if the camera is turned off.
- The White Balance fine adjustment level returns to the standard setting (center point) in the following cases.
  - When you reset the White Balance in [] or []
  - When you reset the color temperature manually in []

## ■ White Balance Bracket

Bracket setting is performed based on the adjustment values for the white balance fine adjustment, and 3 pictures with different colors are automatically recorded when the shutter button is pressed once.

### 1 Press [DISPLAY] in step 2 of the “Finely adjusting the White Balance” procedure, and press ▲/▼/◀/▶ to set the bracket.

◀/▶: Horizontal (A to B)

▲/▼: Vertical (G+ to M-)

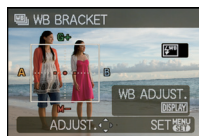

### 2 Press [MENU/SET].

#### Note

- [WB] is displayed in the screen when the White Balance Bracket is set.
- Position of the bracket cannot be set exceeding the limit of the white balance fine adjustment (limit value).
- When the white balance fine adjustment is performed after the setting of the bracket, pictures will be taken with a bracket with the changed adjustment value as the center value.
- The White Balance Bracket setting is released when the power has been turned off (including Sleep Mode).
- You will only hear the shutter sound once.
- White Balance Bracket cannot be set when the [QUALITY] is set to [RAW], [RAW], or [RAW].
- [AUTO BRACKET], [ASPECT BRACKET], [MULTI FILM], or [BURST] will be canceled when White Balance Bracket is set.
- White Balance Bracket does not work when recording motion pictures.
- White Balance Bracket cannot be set in [PIN HOLE] in My Color Mode.

## ■ Auto White Balance

Depending on the conditions prevailing when pictures are taken, the pictures may take on a reddish or bluish tinge. Furthermore, when a multiple number of light sources are being used or there is nothing with a color close to white, Auto White Balance may not function properly. In this case, set the White Balance to a mode other than [AWB].

- 1 Auto White Balance will work within this range
  - 2 Blue sky
  - 3 Cloudy sky (Rain)
  - 4 Shade
  - 5 Sunlight
  - 6 White fluorescent light
  - 7 Incandescent light bulb
  - 8 Sunrise and sunset
  - 9 Candlelight
- K=Kelvin Color Temperature

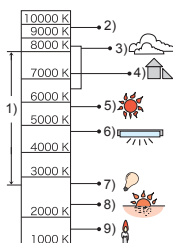

## ■ Setting the color temperature

You can set the color temperature manually for taking natural pictures in different lighting conditions. The color of light is measured as a number in degrees Kelvin. As the color temperature increases, the picture becomes more bluish. As the color temperature decreases, the picture becomes more reddish.

- 1 Select [SET/K] and then press ►.
- 2 Press ▲/▼ to select the color temperature and then press [MENU/SET].
  - You can set a color temperature from [2500K] to [10000K].



## [FACE RECOG.]

For details on [REC] Mode menu settings, refer to P28.

Specify a person's face and use the Face Recognition functions.

Applicable modes: **P A S M**

[OFF]/[ON]/[MEMORY]/[SET]

### Note

- Refer to P113 for details.

## [AF MODE]

For details on [REC] Mode menu settings, refer to P28.

This allows the focusing method that suits the positions and number of the subjects to be selected.

Applicable modes: **P A S M**

: Face Detection	The camera automatically detects the person's face. The focus and exposure can then be adjusted to fit the face no matter what portion of the picture it is in. (max. 15 areas)
: AF Tracking*	Focus and exposure can be adjusted to a specified subject. Focus and exposure will keep on following the subject even if it moves. (Dynamic tracking)
: 23-area-focusing*	Up to 23 points for each AF area can be focused. This is effective when the subject is not in the center of the screen. (AF area frame will be same as image aspect ratio setting.)
: 1-area-focusing	The camera focuses on the subject in the AF area on the screen.

\* will be used during motion picture recording.

**Note**

- The camera is focusing on all the AF areas using [AF-ON] when multiple AF areas (max. 23 areas) light at the same time. If you want to determine the focus position to take pictures, switch the AF Mode to [AF-ON].
- If the AF Mode is set to [AF-ON] or [AF-ON], the AF area is not displayed until the picture is brought into focus.
- The camera may detect the subjects other than a person as the face. In this case, switch the AF Mode to any modes other than [AF-ON] and then take a picture.
- Only [AF-ON] or [AF-ON] can be set during Creative Motion Picture Mode.
- It will be fixed to [AF-ON] when the [FACE RECOG.] is set to [ON].
- The AF Mode cannot be set in [FIREWORKS] in Scene Mode.
- It is not possible to set [AF-ON] in the following cases.
  - In [PANORAMA ASSIST], [NIGHT SCENERY], [FOOD], [STARRY SKY] and [AERIAL PHOTO] in Scene Mode.

**■ About [AF-ON] (Face Detection)**

The following AF area frames are displayed when the camera detects the faces.

Yellow:

When the shutter button is pressed halfway, the frame turns green when the camera is focused.

White:

Displayed when more than one face is detected. Other faces that are the same distance away as faces within the yellow AF areas are also focused.

- Under certain picture-taking conditions including the following cases, the facial recognition function may fail to work, making it impossible to detect faces. [AF MODE] is switched to [AF-ON].
  - When the face is not facing the camera
  - When the face is at an angle
  - When the face is extremely bright or dark
  - When there is little contrast on the faces
  - When the facial features are hidden behind sunglasses, etc.
  - When the face appears small on the screen
  - When there is rapid movement
  - When the subject is other than a human being
  - When the camera is shaking
  - When Digital Zoom is used

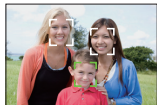

## ■ Setting up [AF/AF] (AF Tracking)

### 1 Bring the subject to the AF tracking frame, and press [AF/AE LOCK] to lock the subject.

- Ⓐ AF tracking frame (White)
- Ⓑ AF tracking frame (Yellow)
- AF area will be displayed in yellow when a subject is recognized, and exposure and focus will automatically adjust continuously following the subject's movement (Dynamic tracking).
- AF tracking is canceled when [AF/AE LOCK] is pressed again.

Before locking



Ⓐ

Locked



Ⓑ

### 2 Take the picture.

#### Note

- If it fails to lock, AF area will flash in red, and disappear. Try to lock again.
- AF tracking will not operate when the subject is not specified, the subject is lost, or has failed to be tracked. The picture will be taken with [ ] in [AF MODE] in that case.
- [FACE RECOG.] does not work when AF tracking is active.
- [Q:AF] will not operate during AF tracking.
- It is not possible to set [AF/AF] in the following cases.
  - In [PANORAMA ASSIST], [STARRY SKY] and [FIREWORKS] in Scene Mode
  - In [STANDARD] (RAW), [DYNAMIC] (RAW) and [SMOOTH] (RAW) in [FILM MODE]
  - In [MONOCHROME], [HIGH DYNAMIC], [DYNAMIC ART], [DYNAMIC] (RAW), [PIN HOLE] and [FILM GRAIN] in My Color Mode
- The focus range is 1 cm (Wide)/30 cm (Tele) to ∞.
- Dynamic tracking function may not work in the following cases:
  - When the subject is too small
  - When the recording location is too dark or bright
  - When the subject is moving too fast
  - When the background has the same or similar color to the subject
  - When camera shake is occurring
  - When using the zoom



## ■ About AF area selection

You can select the AF area by pressing ▲ (FOCUS) when [ ] is selected. It is also possible to switch to AF area selection screen by pressing ► when AF Mode is selected with ▲/▼.

- You can set from the quick menu. (P30)

### 1 Press ▲/▼/◀/▶ to move the AF area.

- You can set to arbitrary position of the screen. (It cannot be set to edge of the screen)
- After moving the AF area, press [DISPLAY] to return it to the center.



### 2 Rotate the rear dial to change the size of AF area.

Rotate to the right: Enlarges the area

Rotate to the left: Reduces the area

- It can be changed to 4 different sizes of “spot” (A), “normal” (B), “large” (C), and “extra large” (D).

### 3 Press [MENU/SET] to set.

- You can also press the rear dial to set.

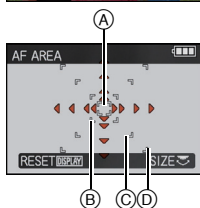

## Note

- AF area cannot be moved and its size cannot be changed during motion picture recording.
- Set the size of AF area to “normal”, “large”, or “extra large” when it is hard to focus using the “spot”.
- The spot metering target can also be moved to match the AF area when using [ ].
- Position of the AF area will return to initial state when the camera is set to Snapshot Mode, when the Sleep Mode is activated, or when the camera is turned off.
- AF is performed at the center position with a large frame instead of the area selected by AF area selection in the following cases:
  - While using Digital Zoom
  - When it is hard to focus due to darkness

## [PRE AF]

For details on [REC] Mode menu settings, refer to P28.

The camera will adjust focus automatically depending on the settings.

Applicable modes: **P A S M C1 C2 SCN** 

[OFF]	
[Q <sub>AF</sub> ]: Quick AF	[Q <sub>AF</sub> ] is displayed on the screen.
[C <sub>AF</sub> ]: Continuous AF*	[C <sub>AF</sub> ] is displayed on the screen.

\* In recording motion pictures, only [C<sub>AF</sub>] (Continuous AF) can be selected.

### About [Q<sub>AF</sub>] and [C<sub>AF</sub>]

[Q<sub>AF</sub>] will adjust the focus automatically when camera shake is minor. [C<sub>AF</sub>] will adjust the focus at all times (Continuous AF).

The camera will adjust the focus automatically, and the focus adjustment when the shutter button is pressed becomes faster. It is effective when you do not want to miss the photo opportunity.

### Note

- The battery will be consumed faster than usual.
- Press the shutter button halfway again when it is difficult to focus on the subject.
- [Q<sub>AF</sub>] will not operate during the AF tracking.
- When [PRE AF] is set to [C<sub>AF</sub>], it may take time to focus on the subject if you rotate the zoom lever from Wide to Tele or suddenly change the subject from a distant one to a nearby one.
- In the following cases, [PRE AF] is fixed to [OFF].
  - In [NIGHT PORTRAIT], [NIGHT SCENERY], [STARRY SKY] and [FIREWORKS] in Scene Mode
  - When Manual Focus is in use

**[AF/AE LOCK]**

For details on [REC] Mode menu settings, refer to P28.

Take a picture with the focus or exposure locked.

This is a technique for setting the focus and the exposure in advance when the subject is outside the focus area or when the contrast is too sharp and the appropriate exposure cannot be achieved.

Applicable modes: **P A S M**  **C1 C2** **SCN** 

<b>[AF]:</b>	<b>Only the focus is locked.</b> • [AF-L] is displayed when the focus is adjusted.
<b>[AE]:</b>	<b>Only the exposure is locked.</b> • [AE-L], aperture value, and shutter speed is displayed when the exposure is adjusted.
<b>[AF/AE]:</b>	<b>Both focus and exposure are locked.</b> • [AF-L], [AE-L], aperture value, and shutter speed are displayed when the focus and exposure are adjusted.

### ■ Setting the AF/AE Lock

- 1 Aim the AF area at the subject.**
- 2 Press [AF/AE LOCK] to fix the focus and exposure.**
  - This does not work when AF tracking is active.
- 3 Move the camera to compose the picture and then press the shutter fully.**

### ■ To cancel the AF/AE Lock

The setting is canceled by pressing the [AF/AE LOCK] again.

#### **Note**

- The exposure is set, even if the brightness of the subject changes in [AE].
- The subject can be focused again by pressing the shutter button halfway even when AE is locked.
- Program Shift can be set even when AE is locked.
- When recording motion pictures after locking, you can continue to record in a locked state in Creative Motion Picture Mode. Lock will be canceled in other modes than Creative Motion Picture Mode.
- Lock is canceled when zooming is performed after locking. Perform the locking again.
- AE Lock will not work in Manual Exposure Mode (when [SENSITIVITY] is set to something other than [AUTO]) and Scene Mode.

## [METERING MODE]

For details on [REC] Mode menu settings, refer to P28.

Type of optical measurement to measure brightness can be changed.

Applicable modes: **P A S M**  **C1 C2** 

: Multiple

This is the method in which the camera measures the most suitable exposure by judging the allocation of brightness on the whole screen automatically. Usually, we recommend using this method.

: Center weighted



This method concentrates metering sensitivity on the subject in the center of the screen while also registering the rest of the frame.

: Spot

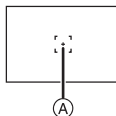
This is the method to measure the subject in the spot metering target (A).



 **Note**

- When  is selected and [AF MODE] is set to , the camera will adjust the exposure to suit the person's face.

## [I.EXPOSURE]





For details on [REC] Mode menu settings, refer to P28.

Contrast and exposure will be adjusted automatically when there is a big difference in brightness between the background and subject, to bring the image close to real life.

Applicable modes: **P A S M**  **C1 C2** 

[OFF]/[LOW]/[STANDARD]/[HIGH]

 **Note**

-  is displayed when it is set to either [LOW], [STANDARD], or [HIGH].
- Even when the [SENSITIVITY] is set to [ISO80]/[ISO100], [SENSITIVITY] may be set higher than [ISO80]/[ISO100] if the picture is taken with [I.EXPOSURE] set to valid.
- Compensation effect may not be achieved depending on the conditions.
-  in the screen turns to yellow when [I.EXPOSURE] is in effect.
- [LOW], [STANDARD], or [HIGH] represents the maximum range of effect.
- The setting is fixed to [OFF] in the following cases.
  - When [QUALITY] is set to , , or [RAW]
  - [MULTI EXPO.]

## [MULTI EXPO.]

For details on [REC] Mode menu settings, refer to P28.

Using this function, you can achieve the kind of effect that is obtained when an image is exposed two or three times.

Applicable modes: **PASMCM**

## 1 Select [START] and then press [MENU/SET].

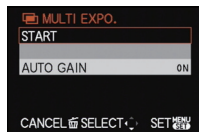

## 2 Decide on the composition, and take the first picture.

- After taking the picture, press the shutter button halfway down to take the next picture.
- Press ▲/▼ to select the item and then press [MENU/SET] for one of the following operations.

[NEXT]: Advance to the next picture.

[RETAKE]: Return to the first picture.

[EXIT]: Record the image of the first picture, and finish the multiple exposure picture-taking session.



## 3 Decide on the composition, and take the second picture.

- After taking the picture, the first and second pictures taken will be superimposed over each other and displayed.
- After taking the picture, press the shutter button halfway down to take the next picture.
- Press ▲/▼ to select the item and then press [MENU/SET] for one of the following operations.

[NEXT]: Advance to the next picture.

[RETAKE]: Return to the second picture.

[EXIT]: Record images up to the second picture taken, and finish the multiple exposure picture-taking session.



## 4 Decide on the composition, and take the third picture.

- After taking the picture, the images of the first, second and third pictures taken will be superimposed over one another and displayed.
- Press ▲ to select [RETAKE] and then press [MENU/SET] to return to the third picture.

## 5 Press ▼ to select [EXIT] and then press [MENU/SET].

- You can also press the shutter button halfway to finish.
- The images up to the third picture taken are recorded, and the multiple exposure picture-taking session will be completed.



## ■ About Automatic Gain Control setting

Select [AUTO GAIN] on the screen shown in step **1** and set it.

[ON]: The brightness level is adjusted according to the number of pictures taken and the pictures are superimposed over each other.

[OFF]: Compensate the exposure to match the subject so that all the superimposed exposure effects will be just right.

### Note

- Image is not recorded until completion.
- The recording information displayed for pictures taken with multiple exposures is the recording information for the last picture taken.
- If [MENU/SET] is pressed while taking pictures, the photographed images are recorded, and the multiple exposure picture-taking session will be completed.
- [RESOLUTION] is fixed when [START] is selected.
- The zoom position and White Balance are fixed when the first picture is taken.
- Some functions have restrictions. You will not be able to use the following functions:
  - [BURST]/[I.EXPOSURE]/[AUTO BRACKET]/[ASPECT BRACKET]/White Balance Bracket/Extended Optical Zoom/[DIGITAL ZOOM]

**[MIN. SHTR SPEED]**

For details on [REC] Mode menu settings, refer to P28.

You can take bright pictures in dark places by setting [MIN. SHTR SPEED] slower. Also, you can set it faster to reduce the blur of the subject.

Applicable modes: **P C1 C2**

[AUTO], [1/250], [1/125], [1/60], [1/30], [1/15], [1/8], [1/4], [1/2], [1]

<b>Minimum shutter speed setting</b>	<b>1/250</b> ← → <b>1</b>
<b>Brightness</b>	Darker <span style="margin-left: 100px;">Brighter</span>
<b>Sharpness of moving subjects</b>	Less <span style="margin-left: 100px;">More</span>

 **Note**

- This should usually be set to [AUTO] to take pictures. (When you select a minimum shutter speed other than [AUTO], [MIN] appears on the screen.)
- When [AUTO] is selected, shutter speed may be set up to 1 second when there is not much camera shake to be adjusted with the [STABILIZER], or when [STABILIZER] is set to [OFF].
- Setting [MIN. SHTR SPEED] to slower speed might increase the chance of camera shake, so we recommend using a tripod and the Self-Timer for taking pictures.
- Setting [MIN. SHTR SPEED] to faster speed might make the picture darker, so we recommend recording the picture in a well-lit area. If correct exposure cannot be achieved, [MIN] will flash in red when the shutter button is pressed halfway.





**[BURST]**

For details on [REC] Mode menu settings, refer to P28.

Pictures are taken continuously while the shutter button is pressed.  
Select the ones you really like from the pictures you have taken.

Applicable modes: **A P A S M C1 C2 SCN** 

[OFF]/

Frame rate/image frequency (pictures/second)		2.5*
Number of recordable pictures		max. 3
		max. 5
	RAW 	max. 3
	RAW 	
	RAW 	

- \* The frame rate is constant regardless of the transfer speed of the card.
- The frame rate values given above apply when the shutter speed is 1/60 or faster.

 **Note**

- The focus, exposure and White Balance are fixed when the first picture is taken. Depending on changes in the brightness of the subject, the recording may be brighter or darker from the second picture.
- When the Self-Timer is used, the number of recordable pictures in Continuous Mode is fixed to 3.
- If you are following a moving subject while taking pictures in a place (landscape) indoors, outdoors etc. where there is a large difference between the light and shade, the exposure may not become optimal.
- The frame rate (pictures/second) may become slower depending on the recording environment such as in dark places, if the ISO sensitivity is high etc.
- Continuous Mode is not canceled when the camera is switched off.
- If you take pictures in Continuous Mode with the internal memory, it will take time to write the picture data.
- **[] is set for the flash when Continuous Mode is set.**
- **When Continuous Mode is set, [AUTO BRACKET], [ASPECT BRACKET], [MULTI FILM] and White Balance Bracket settings will be canceled.**
- **The number of images possible with Continuous Mode is fixed to 3 pictures when external flash is used.**
- Continuous Mode cannot be used in the following cases.
  - In [PANORAMA ASSIST], [HI-SPEED BURST], [FLASH BURST] or [STARRY SKY] in Scene Mode
  - When recording motion pictures
  - [MULTI EXPO.]



**[I.RESOLUTION]**

For details on [REC] Mode menu settings, refer to P28.

Pictures with sharp profile and resolution can be taken by utilising the Intelligent Resolution Technology.

Applicable modes: **P A S M**  **C1 C2** 

[OFF]/[LOW]/[STANDARD]/[HIGH]

 **Note**

- This will be fixed to [LOW] for [HIGH SENS.] and [HI-SPEED BURST] in Scene Mode, to [OFF] for the [PORTRAIT], [SOFT SKIN], [SELF PORTRAIT], [PANORAMA ASSIST], [NIGHT PORTRAIT], [PARTY], [BABY1]/[BABY2], [FLASH BURST], [STARRY SKY] and [FIREWORKS] in Scene Mode, and to [STANDARD] in all other Scene Modes.
- This will be fixed to [LOW] for [HIGH DYNAMIC], [DYNAMIC ART] and [DYNAMIC] () in My Color Mode, to [HIGH] for the [FILM GRAIN] in My Color Mode, and to [OFF] for the [PIN HOLE] in My Color Mode.

**[i.ZOOM]**

For details on [REC] Mode menu settings, refer to P28.

The zoom magnification can be increased by approximately 1.3× without noticeable deterioration in the picture by the Intelligent Resolution Technology.

Applicable modes: **P A S M**  **C1 C2** 

[OFF]/[ON]

 **Note**

- Refer to P54 for details.

**[DIGITAL ZOOM]**

For details on [REC] Mode menu settings, refer to P28.

This mode allows enlarging subjects even more than with Optical Zoom, Extended Optical Zoom, or Intelligent Zoom.

Applicable modes: **P A S M**  **C1 C2** **SCN** 

[OFF]/[ON]

 **Note**

- Refer to P54 for details.
- If camera shake is a problem during zooming, it is recommended that [STABILIZER] be set to [AUTO] or [MODE1].

**[STEP ZOOM]**

For details on [REC] Mode menu settings, refer to P28.

You can zoom to a specified focal length.

Applicable modes: **P A S M C1 C2 SCN** 

[OFF]/[ON]

**Note**

- Refer to P57 for details.

**[STABILIZER]**

For details on [REC] Mode menu settings, refer to P28.

Using one of these modes, camera shake is detected, and automatically compensated, resulting in sharper pictures.

Applicable modes: **P A S M**  **C1 C2 SCN** 

[OFF]

**[AUTO]\*:** The optimum camera shake compensation is selected depending on the condition.

**[MODE1]:** Camera shake is always compensated during [REC] Mode.

**[MODE2]\*:** Camera shake is compensated for when the shutter button is pressed.

\* [MODE1] will be selected during motion picture recording.

**Note**

- The stabilizer function may not be effective in the following cases.
  - When there is a lot of camera shake.
  - When the zoom magnification is high.
  - In Digital Zoom range.
  - When taking pictures while following a moving subject.
  - When the shutter speed becomes slower to take pictures indoors or in dark places.
 Always try to hold the camera as steady as possible, especially when you press the shutter button.
- The setting is fixed to [MODE2] with [SELF PORTRAIT] in Scene Mode and to [OFF] in [STARRY SKY] in Scene Mode.
- Only [OFF] or [MODE1] can be set in Creative Motion Picture Mode.

**[AF ASSIST LAMP]**

For details on [REC] Mode menu settings, refer to [P28](#).

Illuminating the subject makes it easier for the camera to focus when recording in low light conditions that make focusing difficult.

Applicable modes: **P A S M**  **C1 C2** **SCN** 

**[OFF]:** The AF Assist Lamp does not turn on.

**[ON]:** When taking pictures in dark places, the AF Assist Lamp lights while the shutter button is pressed halfway. (Larger AF areas are displayed depending on the recording conditions.)

 **Note**





- The effective range of the AF Assist Lamp is 1.5 m.
- When you do not want to use the AF Assist Lamp  (e.g. when taking pictures of animals in dark places), set the [AF ASSIST LAMP] to [OFF]. In this case, it will become more difficult to focus on the subject.
- In the following cases, [AF ASSIST LAMP] is fixed to [OFF].
  - In [SELF PORTRAIT], [SCENERY], [NIGHT SCENERY], [SUNSET], [FIREWORKS] and [AERIAL PHOTO] in Scene Mode.

**[FLASH]**

For details on [REC] Mode menu settings, refer to [P28](#).

You can switch the flash setting.

Applicable modes: **P A S M** **C1 C2** **SCN** 

 **Note**



- Refer to [P67](#) for details.

## [FLASH SYNCHRO]

For details on [REC] Mode menu settings, refer to P28.

[2ND] (2nd synchro) fires the flash just before the shutter closes. The result is often preferable when slow shutter speeds are used to take pictures of moving objects with their own light sources, such as cars.

Applicable modes: **P A S M C1 C2**

<b>[1ST]:</b>	The normal method when taking pictures with the flash.	
<b>[2ND]:</b>	The light source appears behind the subject and picture becomes dynamic.	

 **Note**

- Set it to [1ST] normally.
- [2nd] is displayed in the flash icon on the screen if you set [FLASH SYNCHRO] to [2ND].
- When a fast shutter speed is set, the effect of [FLASH SYNCHRO] may deteriorate.
- [FLASH SYNCHRO] can be used with an external flash.

## [FLASH ADJUST.]

For details on [REC] Mode menu settings, refer to P28.

You can adjust the flash output.

Applicable modes: **P A S M C1 C2 SCN** 



[-2 EV], [-1 2/3 EV], [-1 1/3 EV], [-1 EV], [-2/3 EV], [-1/3 EV], [0 EV], [+1/3 EV], [+2/3 EV], [+1 EV], [+1 1/3 EV], [+1 2/3 EV], [+2 EV]

 **Note**

- Refer to P71 for details.

**[RED-EYE REMOVAL]**

For details on [REC] Mode menu settings, refer to P28.

When the flash is used with the Red-Eye Reduction ([, [, [) selected, it will automatically detect and correct the red-eye in the image data.

Applicable modes: **P A S M C1 C2 SCN** 

[OFF]/[ON]

 **Note**

- It may not be able to correct the red-eye depending on the recording conditions.
- When the Digital Red-Eye Correction is set to [ON], [] appears on the flash icon.
- Refer to P68 for details.

**[MONITOR MODE]**

For details on [REC] Mode menu settings, refer to P28.



It can be useful to switch off the monitor when an external optical viewfinder is used.

Applicable modes: **P A S M C1 C2 SCN** 

[OFF]

[ON]: LCD monitor is off.

 **Note**

- Display on the LCD monitor is switched by pressing [DISPLAY] for a few times. Refer to P64 for switching display on the LCD monitor.
- The monitor is normally off. However elements such as the focus icon and the flash charging icon are lit.
- Set to [OFF] when not using an external optical viewfinder.
- The default setting for AF Mode is [].
- When set to [ON], [] and [] in [AF MODE] cannot be set.

## [AUTO BRACKET]

For details on [REC] Mode menu settings, refer to [P28](#).

You can take a set of 3 differently exposed images.

 **Note**

- Refer to [P78](#) for details.

## [ASPECT BRACKET]

For details on [REC] Mode menu settings, refer to [P28](#).

You can take 4 pictures with different aspect ratios automatically by pressing the shutter button only once.

Applicable modes: **P A S M C1 C2 SCN** 

[OFF]/[ON]

 **Note**

- Refer to [P79](#) for details.

## [CLOCK SET]

For details on [REC] Mode menu settings, refer to [P28](#).

To set the year, month, day and time.

It functions in exactly the same way as [CLOCK SET] ([P31](#)) in the [SETUP] menu.

## Using the [MOTION PICTURE] Mode Menu

- The [REC] Mode menus below will also be displayed in Creative Motion Picture Mode.
  - [FILM MODE]/[SENSITIVITY]/[ISO LIMIT SET]/[ISO INCREMENTS]/[WHITE BALANCE]/[AF MODE]/[AF/AE LOCK]/[METERING MODE]/[I.EXPOSURE]/[I.RESOLUTION]/[i.ZOOM]/[DIGITAL ZOOM]/[STABILIZER]/[AF ASSIST LAMP]

### [REC MODE]

For details on [MOTION PICTURE] Mode menu settings, refer to [P28](#).

This sets up the data format of motion pictures.

Applicable modes: **A P A S M**  **C1 C2** **SCN** 

 [AVCHD Lite]]/[] [MOTION JPEG]]

#### Note

- Refer to [P108](#) for details.

### [REC QUALITY]

For details on [MOTION PICTURE] Mode menu settings, refer to [P28](#).

This sets up the picture quality of motion pictures.

Applicable modes: **A P A S M**  **C1 C2** **SCN** 

■ When [REC MODE] is  [AVCHD Lite]].

[SH]/[H]/[L]

■ When [REC MODE] is [] [MOTION JPEG]].

[HD]/[WVGA]/[VGA]/[QVGA]

#### Note

- Refer to [P108](#) for details.

## [EXPOSURE MODE]

For details on [MOTION PICTURE] Mode menu settings, refer to [P28](#).

This changes the setup in Creative Motion Picture Mode.

Applicable modes: 

[P]/[A]/[S]/[M]

 **Note**

- Refer to [P111](#) for details.

## [CONTINUOUS AF]

For details on [MOTION PICTURE] Mode menu settings, refer to [P28](#).

It will continually keep on focusing to the subject that the focus was once set.

Applicable modes: **P A S M**  **C1 C2** **SCN** 

[OFF]/[ON]

 **Note**

- When set to [OFF], it may take time for motion picture recording to start.
- Set this function to [OFF] if you wish to fix the focus on the position where you started the motion picture recording.
- In [STARRY SKY] and [FIREWORKS] in Scene Mode, this setting is fixed to [OFF].

## [WIND CUT]

For details on [MOTION PICTURE] Mode menu settings, refer to [P28](#).

This reduces the wind noise in the audio recording.

Applicable modes: **P A S M**  **C1 C2** **SCN** 

[OFF]/[ON]

 **Note**

- Sound quality will be different than usual when [WIND CUT] is set.



## Entering Text

It is possible to enter babies' and pets' names and the names of travel destinations when recording. (Only alphabetical characters and symbols can be entered.)

### 1 Display the entry screen and press ▼ to move to the character selection section.

- You can display the entry screen via the following operations.
  - [USER'S NAME REC] (P39)
  - [NAME] of [BABY1]/[BABY2] or [PET] (P98) in Scene Mode.
  - [NAME] in [FACE RECOG.] (P116)
  - [LOCATION] in [TRAVEL DATE] (P119)
  - [TITLE EDIT] (P162)

### 2 Press ▲/▼/◀/▶ to select text and then press [MENU/SET] to register.

- Press [DISPLAY] to switch text between [A] (capitals), [a] (lower case) and [&/1] (special characters and numbers).
- The entry cursor position can be moved left and right with the zoom lever.
- To enter a blank, move the cursor to [SPACE], to delete an entered character, move the cursor to [DELETE], or to stop editing during text entry, move the cursor to [CANCEL], and press [MENU/SET].
- A maximum of 30 characters can be entered. (Maximum of 9 characters when setting names in [FACE RECOG.]/Maximum of 64 characters when setting [USER'S NAME REC])



### 3 Press ▲/▼/◀/▶ to move the cursor to [SET] and then press [MENU/SET] to end text input.

- Display will return to the appropriate setting screen.

#### Note

- Text can be scrolled if all of the entered text does not fit on the screen.

[PLAYBACK] Mode: 

## Playing Back Pictures in Sequence (Slide Show)



You can play back the pictures you have taken in synchronisation with music, and you can do this in sequence while leaving a fixed interval between each of the pictures.



You can also put together a slide show composed of only still pictures, only motion pictures, only pictures of a particular category, or only favorites.





We recommend this feature when you view your pictures by connecting the camera to a TV.

**1** Press  and then press [MENU/SET].

**2** Press .

**3** Press / to select [SLIDE SHOW], and then press [MENU/SET].

**4** Press / to select the item and then press [MENU/SET].

- [FAVORITE] can be selected only when [FAVORITE] on the [PLAYBACK] menu (P171) is at [ON] and there are pictures already set as favorites.
- During [CATEGORY SELECTION], press /// to select a category, and then press [MENU/SET].  
For details on categories, refer to P157.

**5** Press  to select [START] and then press [MENU/SET].

**6** Press  to finish the slide show.

- Normal playback resumes after the slide show finishes.

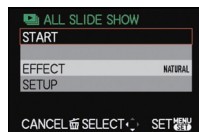
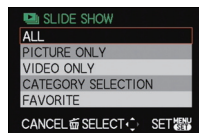

## ■ Operations performed during slide show

The cursor displayed during playback is the same as ▲/▼/◀/▶.

- The menu screen is restored when [⏏] is pressed.

- (A) Play/Pause
- (B) Stop
- (C) Back to previous picture\*
- (D) Ahead to next picture\*

\* These operations can be performed only in the Pause Mode or during motion picture playback.

- (E) Reduce volume level
- (F) Increase volume level

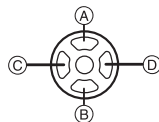

## ■ Changing the slide show settings

You can change the settings for slide show playback by selecting [EFFECT] or [SETUP] on the slide show menu screen.

### [EFFECT]

This allows you to select the screen effects or music effects when switching from one picture to the next.

[NATURAL], [SLOW], [SWING], [URBAN], [OFF], [AUTO]

- When [URBAN] has been selected, the picture may appear in black and white as a screen effect.
- [AUTO] can be used only when [CATEGORY SELECTION] has been selected. The pictures are played back with the recommended effects in each category.
- [EFFECT] is set to [OFF] when playing a slide show with motion pictures only.
- Some [EFFECT] options will not operate when playing back pictures displayed vertically.

### [SETUP]

[DURATION] or [REPEAT] can be set.

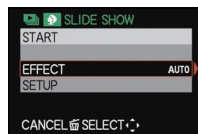

Item	Settings
[DURATION]	1SEC./2SEC./3SEC./5SEC.
[REPEAT]	OFF/ON
[SOUND]	<p>[OFF]: There will be no sound.</p> <p>[AUTO]: Music is played when the still pictures are played back, and audio is played when the motion pictures are played back.</p> <p>[MUSIC]: Music is played back.</p> <p>[AUDIO]: Audio (only for motion pictures) is played back.</p>

- [DURATION] can be set only when [OFF] has been selected as the [EFFECT] setting.

### Note

- It is not possible to add new music.
- [MUSIC] will not display when an HDMI mini cable (available as accessory, see P7) is connected.

[PLAYBACK] Mode: 

## Selecting Pictures and Playing them Back

### [MODE PLAY]

Playback in [PICTURE], [AVCHD Lite], or [MOTION JPEG] can be selected.

- 1** Perform steps 1 and 2 on page 154.
- 2** Press ▲/▼ to select [MODE PLAY] and then press [MENU/SET].
- 3** Press ▲/▼ to select the item and then press [MENU/SET].



## [CATEGORY PLAY]

This mode allows you to search images by Scene Mode or other categories (such as [PORTRAIT], [SCENERY] or [NIGHT SCENERY]) and sort the pictures into each of the categories. You can then play back the pictures in each category.

- 1 Perform steps 1 and 2 on page 154.
- 2 Press ▲/▼ to select [CATEGORY PLAY], and then press [MENU/SET].
- 3 Press ▲/▼/◀/▶ to select the category and then press [MENU/SET] to set.

- If a picture is found in a category, the category icon turns blue.
- It may take time to search the picture files if there are a lot on the card or the internal memory.
- If you press [⏏] while searching, the searching will stop halfway.
- Pictures are sorted into the categories shown below.



[CATEGORY]	Recording information e.g. Scene Modes
	[FACE RECOG.]*
	[PORTRAIT], [i-PORTRAIT], [SOFT SKIN], [SELF PORTRAIT], [NIGHT PORTRAIT], [i-NIGHT PORTRAIT], [BABY1]/[BABY2], [i-BABY]
	[SCENERY], [i-SCENERY], [SUNSET], [i-SUNSET], [AERIAL PHOTO]
	[NIGHT PORTRAIT], [i-NIGHT PORTRAIT], [NIGHT SCENERY], [i-NIGHT SCENERY], [STARRY SKY]
	[SPORTS], [PARTY], [CANDLE LIGHT], [FIREWORKS], [BEACH], [SNOW], [AERIAL PHOTO]
	[BABY1]/[BABY2], [i-BABY]
	[PET]
	[FOOD]
	[TRAVEL DATE]
	[AVCHD Lite], [MOTION JPEG]

- \*Press ▲/▼/◀/▶ to select the person to play back and then press [MENU/SET].  
 Face Recognition may not be possible or may not recognize faces correctly even for registered faces, depending on the facial expression and environment.  
 Also, if there are multiple faces that are already registered in the picture, it will be categorized only once to the person found first in the registration.

## [FAVORITE PLAY]





You can play back the pictures you have set as [FAVORITE] (P171) (Only when [FAVORITE] is set to [ON] and there are pictures which have been set to [FAVORITE]).

- 1** Perform steps 1 and 2 on page 154.
- 2** Press ▲/▼ to select [FAVORITE PLAY], and then press [MENU/SET].

[PLAYBACK] Mode: 

## Playing Back Motion Pictures

- This camera was designed to play motion pictures using the QuickTime Motion JPEG and AVCHD Lite formats that were taken with this model (only).
- Only [AVCHD Lite] motion pictures recorded with this and other Leica digital cameras can be played back with this camera as AVCHD Lite format.

Press /  to select a picture with a **Motion Picture icon (such as **), and then press  to play back.

(A) Motion picture icon

(B) The motion picture recording time

- After playback starts, the elapsed playback time is displayed on the upper right of the screen.

For example, 8 minutes and 30 seconds is displayed as [8m30s].

- Some information (recording information, etc.) is not displayed for motion pictures recorded in [AVCHD Lite].



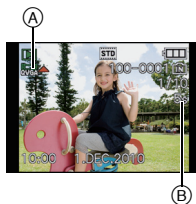

[MOTION JPEG]

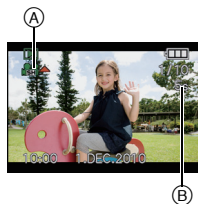

[AVCHD Lite]



### ■ Operations performed during Motion Picture Playback

The cursor displayed during playback is the same as / / / .

(A) Play/Pause

(B) Stop

(C) Fast rewind, Frame-by-frame rewind\*

(D) Fast forward, Frame-by-frame forward\*





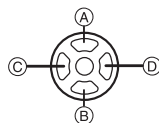

\* These operations can be performed only in the Pause Mode.

(E) Reduce volume level

(F) Increase volume level



### • About fast forward/rewind playback

- Press  during playback to fast forward (press  to rewind). The fast forward/rewind speed increases if you press /  again. (The display on the screen changes from  to .)
- Press  to resume normal playback speed.
- When using a high capacity card, it is possible that fast rewinding may be slower than usual.

### Note

- Sound can be heard through the speaker. Refer to [VOLUME] (P31) for information about how to adjust the volume in the [SETUP] menu.
- To playback the motion pictures recorded by the camera on a PC, use the software available after registering your camera on the Leica Camera AG homepage (see additional leaflet).
- QuickTime Motion JPEG motion pictures that were recorded with a PC or other equipment may have lower image quality or may not be able to play back with the camera.
- Be careful not to block the speaker in the bottom of the camera during playback.

[PLAYBACK] Mode: 

## Creating Still Pictures from a Motion Picture

You can create a single still picture from a recorded motion picture.







**1** Press **▲** to pause Motion Picture playback.

**2** Press [MENU/SET].

**3** Press **▲** to select [YES] and then press [MENU/SET].



### Resolution

[MOTION JPEG]	Resolution	[AVCHD Lite]	Resolution
 ([HD]) /  ([MVGA])	2 M (16:9)	 ([SH]) /  ([H]) /  ([L])	2 M (16:9)
 ([VGA]) /  ([QVGA])	0.3 M (4:3)		

- [QUALITY] is fixed to [..].
- Still pictures created from a motion picture may be coarser than with normal picture quality.

#### Note

- You may not be able to save still pictures from a motion picture taken on other equipment.



[PLAYBACK] Mode: 

## Using the [PLAYBACK] Mode Menu

You can use various functions in Playback Mode to rotate pictures, set protection for them etc.

- With [TEXT STAMP], [RESIZE], [CROPPING] or [LEVELING], a new edited picture is created. A new picture cannot be created if there is no free space on the internal memory or the card so we recommend checking that there is free space and then editing the picture.

### [CALENDAR]

You can display pictures by recording date.

#### 1 Select [CALENDAR] on the [PLAYBACK] Mode menu. (P28)

- You can also rotate the zoom lever several times towards [W] to display the calendar screen. (P59)

#### 2 Press ▲/▼/◀/▶ to select the date to be played back.

- If there were no pictures recorded during a month, that month is not displayed.
- It is also possible to select the date by rotating the rear dial.



#### 3 Press [MENU/SET] to display the pictures that were recorded on the selected date.

- Press [ ] to return to the calendar screen.
- It is also possible to display pictures by pressing the rear dial.



#### 4 Press ▲/▼/◀/▶ to select a picture and then press [MENU/SET].

- The picture that was selected will appear.
- It is also possible to select pictures with the rear dial.

#### Note

- The recording date of the picture selected in the playback screen becomes the date selected when the calendar screen is first displayed.
- If there are multiple pictures with the same recording date, the first picture recorded on that day is displayed.
- You can display the calendar between January 2000 and December 2009.
- If the date is not set in the camera, the recording date is set as the 1st January, 2010.
- If you take pictures after setting the travel destination in [WORLD TIME], the pictures are displayed by the dates at the travel destination in Calendar Playback.

## [TITLE EDIT]

You can add text (comments) to pictures. After text has been registered, it can be stamped in prints using [TEXT STAMP] (P164). (Only alphabetic characters and symbols can be entered.)

**1** Select [TITLE EDIT] on the [PLAYBACK] Mode menu. (P28)

**2** Press ▲/▼ to select [SINGLE] or [MULTI] and then press [MENU/SET].

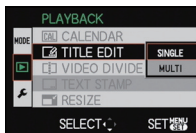

[SINGLE]

[MULTI]

**3** Select the picture, and then press [MENU/SET] to set.

- [ ] is displayed for pictures with titles already registered.

## [MULTI] setting

Press [DISPLAY] to set (repeat), and then press [MENU/SET] to set.



Press ◀/▶ to select the picture.

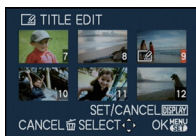

Press ▲/▼/◀/▶ to select the pictures.

- The setting is canceled when [DISPLAY] is pressed again.

**4** Enter the text. (P153)

**5** Press [ ] to return to the menu screen.\*

\*The menu screen is automatically restored when [MULTI] is selected.

- Press [MENU/SET] to close the menu.

**Note**

- To delete the title, erase all the text in the text input screen.
- Text can be scrolled if all of the registered text does not fit on the screen.
- You can set up to 50 pictures at one time with [MULTI].
- You cannot use [TITLE EDIT] for the following types of pictures:
  - Motion pictures
  - Protected pictures
  - Pictures taken with [RAW], [RAW] or [RAW]
  - Pictures recorded with other equipment

## [VIDEO DIVIDE]

Recorded motion picture can be divided in two. It is recommended for when you want to divide a part you need with a part you do not need.

**It cannot be restored once divided.**

**1** Select [VIDEO DIVIDE] on the [PLAYBACK] Mode menu. (P28)



**2** Press ◀/▶ to select the motion picture to divide, and then press [MENU/SET].

- Motion picture is played back.

**3** Press ▲ at the location to divide.

- Motion picture is paused.
- Motion picture is played back from the same location when ▲ is pressed again.



**4** Press ▼.

**5** Press ◀ to select [YES] and then press [MENU/SET].

- Motion picture may be lost if the card or battery is removed while processing the dividing.

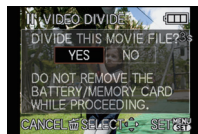

**6** Press [ ] to return to the menu screen.

- Press [MENU/SET] to close the menu.

### Note

- [VIDEO DIVIDE] may not be performed on motion pictures recorded with other equipment.
- Motion pictures cannot be divided at a location close to the start or end of the motion picture.
- With [MOTION JPEG] motion pictures, the order of pictures will change if divided. It is recommended to display these motion pictures by using [CALENDAR] or [MOTION JPEG] in the [MODE PLAY].
- With [AVCHD Lite] motion pictures, the order of pictures will not change.
- Motion pictures cannot be divided in the following cases.
  - Motion pictures set as [FAVORITE]
  - Protected motion pictures
  - Motion pictures with a short recording time

## [TEXT STAMP]

You can stamp the recording date/time, name, location, travel date or title onto the recorded pictures.

It is suitable for regular size printing. (Pictures with a resolution larger than [3M] will be resized when stamping the date etc. on them.)

**1** Select [TEXT STAMP] on the [PLAYBACK] Mode menu. (P28)

**2** Press ▲/▼ to select [SINGLE] or [MULTI] and then press [MENU/SET].



[SINGLE]

[MULTI]

**3** Select the picture, and then press [MENU/SET] to set.

- [ ] appears on screen if the picture is stamped with text.

**[MULTI] setting**

Press [DISPLAY] to set (repeat), and then press [MENU/SET] to set.

- The setting is canceled when [DISPLAY] is pressed again.



Press ◀/▶ to select the picture.

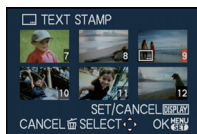

Press ▲/▼/◀/▶ to select the pictures.

**4** Press ▲/▼ to select text stamp items, and then press ▶.

## 5 Press ▲/▼ to select the settings, and then press [MENU/SET].

Item	Setting item
[SHOOTING DATE]	[OFF] [W/OTIME]: Stamp the year, month and date. [WITHTIME]: Stamp the year, month, day, hour and minutes.
[NAME]	[OFF] []: Stamps names registered in name settings for [FACE RECOG]. [/]: Stamps names registered in name settings for [BABY1]/[BABY2] or [PET] in Scene Mode.
[LOCATION]	[OFF] [ON]: Stamps the travel destination name set under [LOCATION].
[TRAVEL DATE]	[OFF] [ON]: Stamps the travel date set under [TRAVEL DATE].
[TITLE]	[OFF] [ON]: Title input in the [TITLE EDIT] will be stamped.

## 6 Press [MENU/SET].

- If you set [TEXT STAMP] for a picture with a resolution larger than (1:1/[25M]), (4:3/[3M]), (3:2/[3M]) or (16:9/[25M]), the resolution will become smaller as shown below.

Aspect ratio setting	Resolution
1:1	<u>75M</u> / <u>55M</u> / <u>35M</u> → <u>25M</u>
4:3	<u>10M</u> / <u>7M</u> / <u>5M</u> → <u>3M</u>
3:2	<u>95M</u> / <u>65M</u> / <u>45M</u> → <u>3M</u>
16:9	<u>9M</u> / <u>6M</u> / <u>45M</u> → <u>25M</u>

- When selecting [] or [/], press ▲ to select [YES] for stamping [AGE], and then press [MENU/SET] and proceed to step 7.

## 7 Press **▲** to select [YES] and then press [MENU/SET].

- The message [SAVE NEW PICTURES?] appears if the picture was recorded with a resolution of [3M] or less.



## 8 Press **[🗑️]** to return to the menu screen.\*

- \*The menu screen is automatically restored when [MULTI] is selected.
- Press [MENU/SET] to close the menu.

### Note

- When you print pictures stamped with text, the date will be printed over the stamped text if you specify printing of the date at the photo shop or on the printer.
- You can set up to 50 pictures at one time in [MULTI].
- The picture quality may deteriorate when text stamping is carried out.
- Depending on the printer being used, some characters may be cut at printing. Check before printing.
- When text is stamped onto the [0.2M]/[0.3M]/[0.3M]/[0.2M] pictures, it is difficult to read it.
- Text and dates cannot be stamped on the pictures in the following cases.
  - Motion pictures
  - Pictures recorded without setting the clock and title
  - Pictures that were previously stamped with [TEXT STAMP]
  - Pictures taken with [RAW], [RAW] or [RAW]
  - Pictures recorded with other equipment

## [RESIZE] Reducing the resolution

To allow easy posting to web pages, attachment to e-mail etc., the resolution (number of pixels) can be reduced.

**1** Select **[RESIZE]** on the **[PLAYBACK]** Mode menu. (P28)

**2** Press **▲/▼** to select **[SINGLE]** or **[MULTI]** and then press **[MENU/SET]**.



**3** Select the picture and resolution.

### [SINGLE] setting

**1** Press **◀/▶** to select the picture, and then press **[MENU/SET]**.

**2** Press **◀/▶** to select the resolution\*1, and then press **[MENU/SET]**.

\*1 Only the resolutions to which the pictures can be resized are displayed.

### [SINGLE]



### [MULTI] setting

**1** Press **▲/▼** to select the resolution, and then press **[MENU/SET]**.

• When **[DISPLAY]** is pressed, an explanation of resizing is displayed.

**2** Press **▲/▼/◀/▶** to select the picture, and then press **[DISPLAY]**.

• Repeat this step for each picture, and press **[MENU/SET]** to set.

### [MULTI]

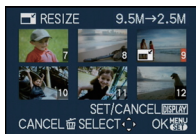

**4** Press **▲** to select **[YES]** and then press **[MENU/SET]**.

**5** Press **[🗑️]** to return to the menu screen.\*2

\*2 The menu screen is automatically restored when **[MULTI]** is selected.

• Press **[MENU/SET]** to close the menu.



### Note

- You can set up to 50 pictures at one time in **[MULTI]**.
- The picture quality of the resized picture will deteriorate.
- It may not be possible to resize pictures recorded with other equipment.
- Motion pictures, pictures stamped with **[TEXT STAMP]** and pictures taken with **[RAW]**, **[RAW]** or **[RAW]** cannot be resized.

**[CROPPING]**

You can enlarge and then crop the important part of the recorded picture.

**1** Select **[CROPPING]** on the **[PLAYBACK] Mode menu**. (P28)

**2** Press **◀/▶** to select the picture, and then press **[MENU/SET]**.



**3** Use the zoom lever and press **▲/▼/◀/▶** to select the parts to be cropped.



Zoom lever (T): Enlargement

Zoom lever (W): Reduction

▲/▼/◀/▶: Move

Reduction



Enlargement

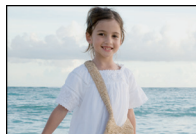

Move the position

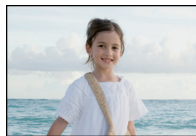
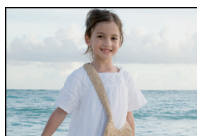

**4** Press **[MENU/SET]**.

**5** Press **▲** to select **[YES]** and then press **[MENU/SET]**.



**6** Press **[🗑️]** to return to the menu screen.

• Press **[MENU/SET]** to close the menu.

**Note**

- The resolution of the cropped picture will be lower than that of the original picture.
- The picture quality of the cropped picture will deteriorate.
- It may not be possible to crop pictures recorded with other equipment.
- Motion pictures, pictures stamped with **[TEXT STAMP]** and pictures taken with **[RAW]**, **[RAW]** or **[RAW]** cannot be cropped.
- Information regarding the Face Recognition in the original picture will not be copied to images having undergone **[CROPPING]**.



## [LEVELING]

Minute leveling of the image can be adjusted.

- 1 Select [LEVELING] on the [PLAYBACK] Mode menu. (P28)
- 2 Press ◀/▶ to select the picture, and then press [MENU/SET].
- 3 Press ◀/▶ to adjust the leveling, and press [MENU/SET].
  - ▶: clockwise
  - ◀: counter-clockwise
  - Up to 2° can be adjusted.
- 4 Press ▲ to select [YES] and then press [MENU/SET].



- 5 Press [EXIT] to return to the menu screen.
  - Press [MENU/SET] to close the menu.

#### Note

- Quality of image may become coarse when leveling is performed.
- The resolution may decrease compared to original image when leveling is performed.
- Leveling may not be performed on images recorded with other equipment.
- Leveling may not be possible with still pictures created from motion pictures.
- Motion pictures, pictures stamped with [TEXT STAMP] and pictures taken with [RAW], [RAW] or [RAW] cannot be leveled.
- Information regarding the Face Recognition in the original picture will not be copied to images having undergone [LEVELING].

**[ROTATE DISP.]**

This mode allows you to automatically display pictures vertically if they were recorded holding the camera vertically.

**1** Select **[ROTATE DISP.]** on the **[PLAYBACK] Mode menu. (P28)**

**2** Press **▼** to select **[ON]** and then press **[MENU/SET]**.

- The pictures are displayed without being rotated when you select **[OFF]**.
- Refer to [P58](#) for information about how to play back pictures.

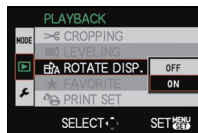

**3** Press **[MENU/SET]** to close the menu.

**Note**

- When you play back pictures on a PC, they cannot be displayed in the rotated direction unless the OS or software is compatible with Exif. Exif is a file format for still pictures which allows recording information etc. to be added. It was established by "JEITA (Japan Electronics and Information Technology Industries Association)".
- It may not be possible to rotate pictures that have been recorded with other equipment.
- The display is not rotated during Multi Playback ([P59](#)).

## [FAVORITE]

You can do the following if a mark has been added to pictures and they have been set as favorites.

- Play back only the pictures set as favorites. ([FAVORITE PLAY])
- Play back the pictures set as favorites only as a slide show.
- Delete all the pictures not set as favorites. ([ALL DELETE EXCEPT★])

## 1 Select [FAVORITE] on the [PLAYBACK] Mode menu. (P28)

## 2 Press ▼ to select [ON] and then press [MENU/SET].

- You cannot set pictures as favorites if [FAVORITE] is set to [OFF]. Also [★] will not appear when [FAVORITE] is set to [OFF] even if it was previously set to [ON].

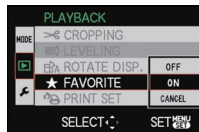

## 3 Press [MENU/SET] to close the menu.

## 4 Press ◀/▶ to select the picture and then press ▼.

- Repeat the above procedure.
- If ▼ is pressed again, the favorite setting is canceled.



### ■ Canceling all the [FAVORITE] settings

#### 1 Select [CANCEL] on the screen shown in step 2 and then press [MENU/SET].

#### 2 Press ▲ to select [YES] and then press [MENU/SET].

#### 3 Press [MENU/SET] to close the menu.

- You cannot select [CANCEL] if not even one picture has been set as a favorite.

### Note

- You can set up to 999 pictures as favorites.
- When printing pictures at a photo printing store, [ALL DELETE EXCEPT★] (P63) is useful so only the pictures you want to be printed remain on the card.
- You may not be able to set pictures taken with other equipment as favorites.
- The pictures that were taken with the [QUALITY] set to [RAW] cannot be set to [FAVORITE].

## [PRINT SET]

DPOF “Digital Print Order Format” is a system that allows the user to select which pictures to print, how many copies of each picture to print and whether or not to print the recording date on the pictures when using a DPOF compatible photo printer or photo printing store. For details, ask at your photo printing store.

When you want to use a photo printing store to print pictures recorded on the internal memory, copy them to a card (P176) and then set the print setting.

**1** Select [PRINT SET] on the [PLAYBACK] Mode menu. (P28)

**2** Press ▲/▼ to select [SINGLE] or [MULTI] and then press [MENU/SET].



[SINGLE]

[MULTI]

**3** Select the picture, and then press [MENU/SET].



Press ◀/▶ to select the picture.

Press ▲/▼/◀/▶ to select the pictures.

**4** Press ▲/▼ to set the number of prints, and then press [MENU/SET] to set.

- When [MULTI] has been selected, repeat steps **3** and **4** for each picture. (It is not possible to use the same setting for a multiple number of pictures.)

**5** Press [🗑️] to return to the menu screen.

- Press [MENU/SET] to close the menu.

### ■ Canceling all the [PRINT SET] settings

- 1 Select [CANCEL] on the screen shown in step 2 and then press [MENU/SET].
- 2 Press ▲ to select [YES] and then press [MENU/SET].
- 3 Press [MENU/SET] to close the menu.

- You cannot select [CANCEL] if not even one picture has been set for printing.

### ■ To print the date

After setting the number of prints, set/cancel printing with the recording date by pressing [DISPLAY].

- When you go to a photo printing store for digital printing, be sure to order the printing of the date additionally if required.
- Depending on the photo printing store or the printer, the date may not be printed even if you set to print the date. For further information, ask at your photo printing store or refer to the instructions for the printer.
- The date cannot be printed on pictures stamped with text.



### Note

- The number of prints can be set from 0 to 999.
- With a printer supporting PictBridge, the date print settings of the printer may take precedence so check if this is the case.
- It may not be possible to use the print settings with other equipment. In this case, cancel all the settings, and reset the settings.
- [PRINT SET] cannot be set for motion pictures and pictures that were taken with the [QUALITY] set to [RAW].
- If the file is not based on the DCF standard, the print setting cannot be set.

**[PROTECT]**

You can set protection for pictures you do not want to be deleted by mistake.

**1** Select **[PROTECT]** on the **[PLAYBACK]** Mode menu. **(P28)**

**2** Press **▲/▼** to select **[SINGLE]** or **[MULTI]** and then press **[MENU/SET]**.

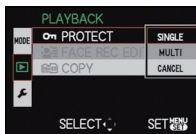

**[SINGLE]**

**[MULTI]**

**3** Select the picture, and then press **[MENU/SET]**.

When **[MULTI]** has been selected

- Repeat these steps for each picture.
- The settings are canceled when **[MENU/SET]** is pressed again.



Press **◀/▶** to select the picture.

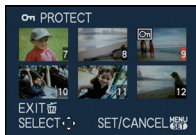

Press **▲/▼/◀/▶** to select the pictures.

**4** Press **[🗑️]** to return to the menu screen.

- Press **[MENU/SET]** to close the menu.

#### ■ Canceling all the **[PROTECT]** settings

**1** Select **[CANCEL]** on the screen shown in step 2 and then press **[MENU/SET]**.

**2** Press **▲** to select **[YES]** and then press **[MENU/SET]**.

**3** Press **[MENU/SET]** to close the menu.

- If you press **[MENU/SET]** while canceling protection, the canceling will stop halfway.

#### Note

- The protect setting may not be effective on other equipment.
- Formatting will delete the respective pictures even if they are protected and regardless of whether they are saved to the internal memory or a card.
- Even if you do not protect pictures on a card, they cannot be deleted when the card's Write-Protect switch is set to **[LOCK]**.

## [FACE REC EDIT]

You can delete or change the information relating to Face Recognition for the selected picture.

**1** Select [FACE REC EDIT] on the [PLAYBACK] Mode menu. (P28)

**2** Press ▲/▼ to select [REPLACE] or [DELETE] and then press [MENU/SET].

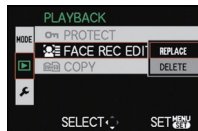

**3** Press ◀/▶ to select the picture and then press [MENU/SET].

- You cannot select pictures for which Face Recognition information has not been registered.



**4** Press ◀/▶ to select the person and then press [MENU/SET].

- [DELETE] → step 6.
- You cannot select a person who has not been registered.



**5** Press ▲/▼/◀/▶ to select the person to replace and then press [MENU/SET].

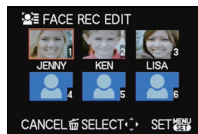

**6** Press ▲ to select [YES] and then press [MENU/SET].

**7** Press [EXIT] to return to the menu screen.

- Press [MENU/SET] to close the menu.

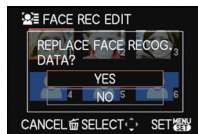

### Note

- Cleared information regarding the [FACE RECOG.] cannot be restored.
- When all Face Recognition information in a picture has been canceled, the picture will not be categorized using Face Recognition in [CATEGORY PLAY].
- You cannot edit the Face Recognition information of protected pictures.

**[COPY]**

You can copy the data of the pictures you have taken from the internal memory to a card or from a card to the internal memory.

**1** Select **[COPY]** on the **[PLAYBACK] Mode menu. (P28)**

**2** Press **▲/▼** to select the copy destination and then press **[MENU/SET]**.

**[IN]→[SD]**: All the picture data in the internal memory is copied onto the card at one time. → step **4**.

**[SD]→[IN]**: One picture at a time is copied from the card to the internal memory. → step **3**.

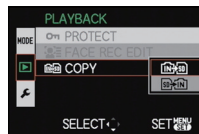

**3** Press **◀/▶** to select the picture and then press **[MENU/SET]**.

**4** Press **▲** to select **[YES]**, and then press **[MENU/SET]**.

- If you press **[MENU/SET]** while copying pictures, the copying will stop halfway.
- Do not turn the camera off at any point during the copying process.



**5** Press **[EXIT]** to return to the menu screen.

- Press **[MENU/SET]** to close the menu.
- If you copy from the internal memory to a card, all the pictures are copied and then the screen automatically returns to the playback screen.

### Note

- If you copy picture data from the internal memory to a card which does not have sufficient free space, the picture data will only be copied halfway. We recommend using a card which has more free space than the internal memory (about 40 MB).
- If a picture exists with the same name (folder number/file number) as the picture to be copied in the copy destination when **[IN]→[SD]** is selected, a new folder is created and the picture is copied. If a picture exists with the same name (folder number/file number) as the picture to be copied in the copy destination when **[SD]→[IN]** is selected, that picture is not copied. (P209)
- It may take time to copy the picture data.
- Only pictures recorded with a Leica digital camera (except DIGILUX, DIGILUX ZOOM, DIGILUX 4.3) will be copied. (Even if the pictures were recorded with a Leica digital camera, you may not be able to copy them if they were edited with a PC.)
- **[PRINT SET]**, **[PROTECT]** or **[FAVORITE]** settings will not be copied. Perform the settings again after copying is finished.
- Motion picture recorded in **[AVCHD Lite]** cannot be copied.



[PLAYBACK] Mode: 

## Playing Back Pictures on a TV

### Playing back pictures using the AV cable (supplied)

Preparations:

Set the [TV ASPECT]. (P37)

Turn off the camera and the TV.

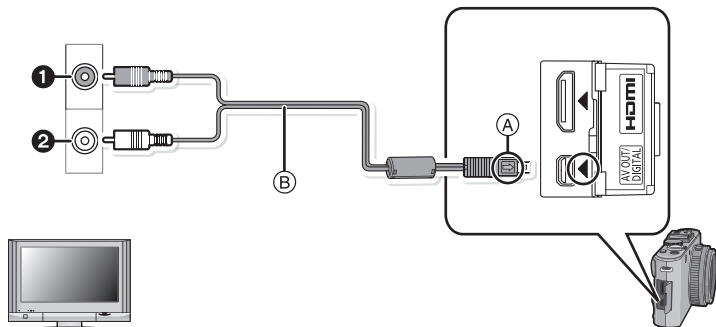

① Yellow: to the video input socket

② White: to the audio input socket

(A) Align the marks, and insert.

(B) AV cable (supplied)

• Make sure the plugs are aligned correctly and that they are inserted and pulled out straight. (Otherwise they may be bent out of shape which may cause malfunction.)

**1** Connect the AV cable (B) (supplied) to the video input and the audio input sockets on the TV.

**2** Connect the AV cable to the [AV OUT] socket on the camera.

**3** Turn the TV on and select external input.

**4** Turn the camera on and then press [▶].

 **Note**

- Depending on the aspect ratio, the top and bottom or the left and right edges of the TV screen may remain black.
- Do not use any other AV cables except the supplied one.
- Read the instructions for the TV.
- When you play back a picture vertically, it may be blurry.
- You can view pictures on TVs in other countries (regions) which use the NTSC or PAL system when you set [VIDEO OUT] in the [SETUP] menu.

**Playing back pictures on a TV with an SD Memory Card slot**

The recorded still pictures can be played back on a TV with an SD Memory Card slot.

 **Note**

- Depending on the TV model, pictures may not be displayed on the full screen.
- Motion pictures recorded with [AVCHD Lite] can be played back on compatible TVs, i.e. with the AVCHD logo mark. In all other cases, connect the camera to the TV using the AV cable (supplied) and playback the motion picture.
- SDHC Memory Cards cannot be played back unless it is a TV compatible with SDHC Memory Cards or SDXC Memory Cards.
- SDXC Memory Cards cannot be played back unless it is a TV compatible with SDXC Memory Cards.

**Playing back pictures on a TV with an HDMI socket**

You can enjoy high quality pictures and motion pictures on the TV by connecting the camera with the HDMI compatible high definition TV using HDMI mini cable (available as accessory, see [P7](#)).

**What is HDMI?**

HDMI is the interface for digital devices. When the camera is connected to a HDMI compatible device, the image and audio can be output with a digital signal. If you connect the camera to a HDMI compatible high definition TV and then play back the recorded high definition images, you can enjoy them in high resolution with high quality sound.

If you connect the camera to a TV compatible with HDTV Link, linked operations (HDTV Link) are possible. ([P181](#))

Preparations:

Check the [HDMI MODE]. (P38)

Turn off the camera and the TV.

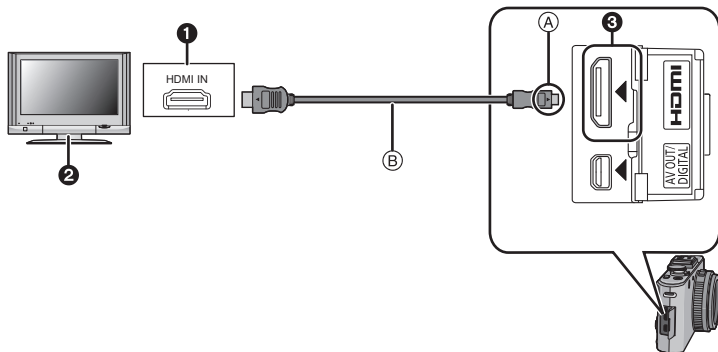

① HDMI socket

② TV with HDMI socket

③ HDMI mini socket (C type)

Ⓐ Align the marks, and insert.

Ⓑ HDMI mini cable (available as accessory, see P7)

• Make sure the plugs are aligned correctly, that they are inserted and pulled out straight, and that this is done holding the plugs only. (It may result in malfunction due to bent terminals if they are plugged in obliquely or in the wrong direction.)

**1** Connect the HDMI mini cable Ⓑ (available as accessory, see P7) to the HDMI input socket on the TV.

**2** Connect the HDMI mini cable to the [HDMI] socket on the camera.

**3** Turn the TV on and switch to HDMI input.

**4** Turn the camera on and then press [▶].

• When [HDTV Link] (P38) is set to [ON] and the camera is connected to a TV supporting HDTV Link, input of the TV will be switched automatically and playback screen will be displayed (P181).

 **Note**

- Depending on the aspect ratio, the top and bottom or the left and right edges of the TV screen may remain black.
- Always use the genuine Leica HDMI mini cable (available as accessory, see P7).
- During HDMI output, no picture is displayed on the LCD monitor/Electronic Viewfinder EVF1 (available as accessory, see P7).
- Output from the HDMI mini cable has priority when both AV cable and HDMI mini cable are connected.
- HDMI output is not possible even if you connect the HDMI mini cable while the camera is connected to the PC or the printer.
- HDMI connection is disabled and connection with the USB connection cable will take priority when you connect the USB connection cable while the HDMI mini cable is connected.
- When pictures are displayed, they may not be displayed properly depending on the type of TV.
- Read the instructions for the TV.
- Audio will be played back as monaural.
- Following functions cannot be set in Playback Mode.  
[TITLE EDIT], [VIDEO DIVIDE], [TEXT STAMP], [RESIZE], [CROPPING], [LEVELING],  
[FACE REC EDIT], [COPY], multiple selection etc.

## Playback using HDTV Link (HDMI)

### What is the HDTV Link?

- This function allows you to use the remote control of compatible TVs for easy operations when the camera is connected to a HDTV Link compatible device using a HDMI mini cable (available as accessory, see [P7](#)) for automatic linked operations. (Not all operations are possible.)
- HDTV Link is a unique function built on a HDMI control function using the standard HDMI CEC (Consumer Electronics Control) specification. Linked operations with HDMI CEC compatible devices made by other companies are not guaranteed. When using devices made by other companies that are compatible with HDTV Link, refer to the instructions for the respective devices.
- This camera is compatible with HDTV Link Ver.5. HDTV Link Ver.5 is the newest version and is also compatible with existing HDTV Link compatible devices.

Preparations:

Set the [HDTV Link] to [ON]. ([P38](#))

**1** Connect the camera to a TV compatible with HDTV Link with a HDMI mini cable (available as accessory, see [P7](#)) ([P178](#)).

**2** Turn the camera on and then press [**▶**].

**3** Operate with the remote control for the TV.

TV compatible with HDTV Link



\* The shape of the remote control varies depending on the region. Operate following the TV guide displayed on screen.

 **Note**

- It is recommended to connect the camera to an HDMI terminal other than the HDMI1 if there are 2 or more HDMI input terminals on the TV.
- When the [HDTV Link] (P38) of the camera is set to [ON], operation using the button on the camera will be limited.
- HDTV Link must be activated on the connected TV. (Read the instructions of the TV for how to set etc.)
- If you are not using HDTV Link, set [HDTV Link] (P38) to [OFF].
- If you are unsure whether or not the TV you are using is compatible with HDTV Link, read its instructions.
- Available linked operations between the camera and compatible TVs may be different depending on the specific models even if they are compatible with HDTV Link. Refer to the instructions of the TV for the supported operations.
- Operation is not possible with a cable that is not based on the HDMI standard.
- Always use the genuine Leica HDMI mini cable (available as accessory, see P7).
- HDTV Link will not work even if you connect the HDMI mini cable when the camera is connected to a PC or a printer.
- [HDMI MODE] (P38) for the camera is determined automatically when the HDTV Link is operating.
- The resolution may switch automatically when an [AVCHD Lite] motion picture that was recorded with another camera is played back on the camera. The screen may turn black for a while when that occurs, but it is not a malfunction.

## Saving the Recorded Still Pictures and Motion Pictures

Methods to export still pictures and motion pictures to other devices will vary depending on the file format. (JPEG, RAW, AVCHD Lite, or Motion JPEG). Here are a few suggestions.

### Copying the playback image using an AV cable

File formats that can be used: [AVCHD Lite], [Motion JPEG]

Copy images played back with the camera to DVD disc, hard disk, or video using a DVD recorder, or video.

This can be played back with equipment that is not compatible with high definition (AVCHD), so it is convenient for distributing copies. Image will be standard quality instead of high definition at this time.

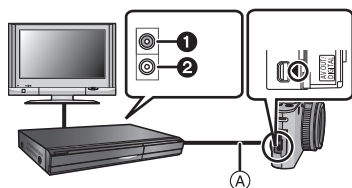

- ① Yellow: to the video input socket
- ② White: to the audio input socket
- Ⓐ AV cable (supplied)

- 1** Connect the camera with the recording equipment with an AV cable (supplied).
- 2** Start the playback of the camera.
- 3** Start the recording on the recording equipment.

- When ending the recording (copying), stop the playback on the camera after stopping the recording of the recording equipment.

#### Note

- When you play back motion pictures on 4:3 aspect ratio TV, you must set [TV ASPECT] (P37) on the camera to [4:3] before starting a copy. The image will be vertically long if you play back motion pictures copied with [16:9] setting on a [4:3] aspect TV.
- Do not use any other AV cables except the supplied one.
- It is recommended to turn off the display of the screen by pressing the [DISPLAY] on the camera while copying. (P64)
- See the instruction manual for the recording equipment regarding the details of copying and playing back.

## Connecting to a PC

You can acquire recorded pictures to a PC by connecting the camera and the PC.

- Some PCs can read directly from the card removed from the camera. For details, refer to the instructions of your PC.
- **If the computer being used does not support SDXC Memory Cards, a message prompting you to format may appear. (Doing so will cause recorded images to be erased so do not choose to format.)**
- You can easily print out or mail the pictures you have imported using the software available as download after registering your camera on the Leica Camera AG homepage (see separate leaflet).
- Read the instructions for the software for more information and about how to install it.

### ■ PC that can be used

	Windows			Macintosh
	98/98SE	Me/2000	XP/Vista/7	OS 9/OS X
Can the downloaded software be used?	—		○*1	—
Can the [AVCHD Lite] motion picture be acquired to the PC?	—		○	—
Can the still pictures and [MOTION JPEG] motion pictures in the digital camera be acquired to the PC using a USB connection cable?	—		○	○ (OS 9.2.2/OS X [10.1~10.6])

• PC with Windows 98/98SE or older, or Mac OS 8.x or older cannot be connected via USB, but it can acquire the pictures if an SD memory card reader/writer can be used.

\*1 It is necessary for Internet Explorer 6.0 or newer to be installed. PC with higher processing performance is required depending on the function to be used. It may not play back correctly or operate correctly depending on the environment of the PC used.



## Acquiring of still pictures and [MOTION JPEG] motion pictures (other than [AVCHD Lite] motion pictures)

### Preparations:

Turn on the camera and the PC.

Remove the card before using the pictures in the internal memory.

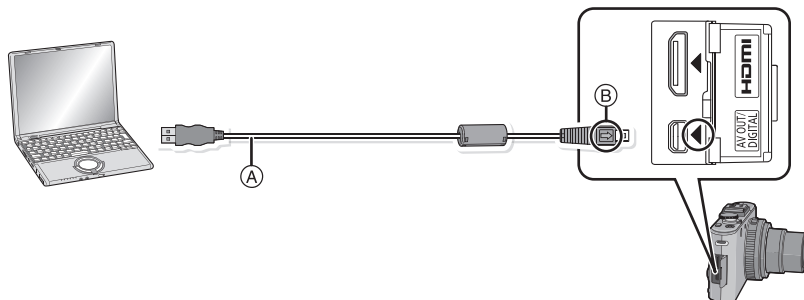

Ⓐ USB connection cable (supplied)

• Make sure the plug is aligned correctly and that it is inserted straight. (Otherwise, it may cause deformation on both sides resulting in malfunction.)

Ⓑ Align the marks, and insert.

• Use a battery with sufficient battery power. If the remaining battery power becomes low while the camera and the PC are communicating, the status indicator flashes and the alarm beeps. Refer to "Disconnecting the USB connection cable safely" (P187) before disconnecting the USB connection cable. Otherwise, data may be destroyed.

## 1 Connect the camera to a PC via the USB connection cable (supplied). (A)

- Do not use any other USB connection cables except the supplied one. Use of cables other than the supplied USB connection cable may cause malfunction.

## 2 Press **▲/▼** to select [PC], and then press [MENU/SET].

- If [USB MODE] (P37) is set to [PC] in the [SETUP] menu in advance, the camera will be automatically connected to the PC without displaying the [USB MODE] selection screen. Since there is no need to set this each time you connect to the PC, it is convenient.
- When the camera has been connected to the PC with [USB MODE] set to [PictBridge(PTP)], a message may appear on the PC's screen. Select [Cancel] to close the screen, and disconnect the camera from the PC. Then set [USB MODE] to [PC] again.

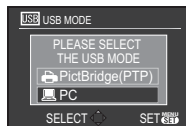

## 3 Double-click on [Removable Disk] in [My Computer].

- When using a Macintosh, the drive is displayed on the desktop. ("LEICA", "NO\_NAME" or "Untitled" is displayed.)

## 4 Double-click [DCIM] folder.

## 5 Using a drag-and-drop operation, move the pictures you want to acquire or the folder storing those pictures to any different folder on the PC.

### ■ Disconnecting the USB connection cable safely

- Proceed with the hardware removal using "Safely Remove Hardware" on the task tray of the PC. If the icon is not displayed, check that [ACCESS] is not displayed on the LCD monitor of the digital camera before removing the hardware.

### Note

- Before inserting or removing a card, turn the camera off and disconnect the USB connection cable. Otherwise, data may be destroyed.

## ■ Viewing the contents of the internal memory or card using the PC (folder composition)

Folders and images processed in the PC cannot be played back on the camera. It is recommended to use the software available as download after registering your camera on the Leica Camera AG homepage (see separate leaflet) when you write the image from PC to a card.

- Internal memory
- Card

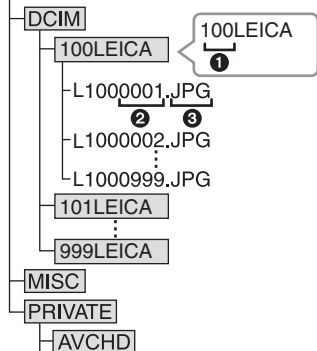

- |   |               |                               |
|---|---------------|-------------------------------|
| ① | Folder number |                               |
| ② | File number   |                               |
| ③ | JPG:          | Pictures                      |
|   | MOV:          | [MOTION JPEG] Motion pictures |
|   | RWL:          | Pictures in RAW files         |
|   | MISC:         | DPOF print                    |
|   |               | Favorite                      |
|   | AVCHD:        | [AVCHD Lite] Motion pictures  |

A new folder is created when pictures are taken in the following situations.

- After [NO.RESET] (P36) in the [SETUP] menu has been executed
- When a card containing a folder with the same folder number has been inserted (Such as when pictures were taken using another make of camera)
- When there is a picture with file number 999 inside the folder

## ■ Connection in the PTP Mode (Windows® XP, Windows Vista®, Windows® 7 and Mac OS X only)

Set [USB MODE] to [PictBridge(PTP)].

Data can now be read only from the card into the PC.

- When there are 1000 or more pictures on a card, the pictures may not be imported in the PTP Mode.
- [AVCHD Lite] motion picture cannot be played back in PTP Mode.

## Printing the Pictures

If you connect the camera to a printer supporting PictBridge, you can select the pictures to be printed out and instruct that printing be started from the camera's LCD monitor.

• Some printers can print directly from the card removed from the camera. For details, refer to the instructions of your printer.

Preparations:

Turn on the camera and the printer.

Remove the card before printing the pictures from the internal memory.

Perform the print quality and other settings at the printer before printing the pictures.

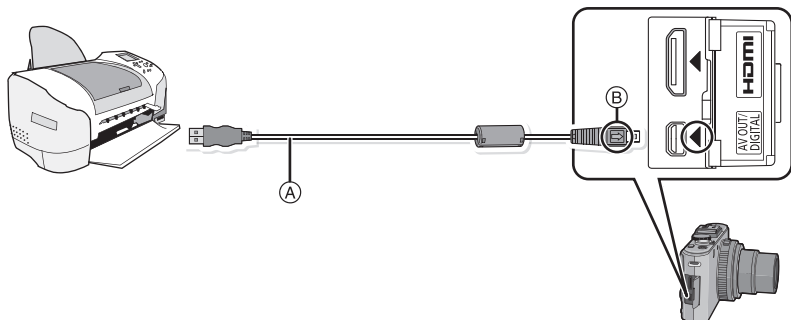



Ⓐ USB connection cable (supplied)

• Make sure the plugs are aligned correctly and that they are inserted and pulled out straight. (Otherwise they may be bent out of shape which may cause malfunction.)

Ⓑ Align the marks, and insert.

• Use a battery with sufficient battery power. If the remaining battery power becomes low while the camera and the printer are connected, the status indicator flashes and the alarm beeps. If this happens during printing, stop printing at once. If not printing, disconnect the USB connection cable.

## 1 Connect the camera to a printer via the USB connection cable (supplied). (A)

- When the camera is connected to the printer, the cable disconnect prohibit icon  appears. Do not disconnect the USB cable while  is displayed.

## 2 Press **▲/▼** to select [PictBridge(PTP)], and then press [MENU/SET].

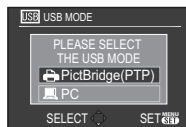

### Note

- Do not use any other USB connection cables except the supplied one. Use of cables other than the supplied USB connection cable may cause malfunction.
- Before inserting or removing a card, turn the camera off, and disconnect the USB connection cable.
- You cannot switch between the internal memory and the card while the camera is connected to the printer. Disconnect the USB connection cable, insert (or remove) the card and then connect the USB connection cable to the printer again.
- Motion pictures cannot be printed out.

## Selecting a single picture and printing it

### 1 Press **◀/▶** to select the picture and then press [MENU/SET].

- The message disappears in about 2 seconds.



### 2 Press **▲** to select [PRINT START] and then press [MENU/SET].

- Refer to P192 for the items which can be set before starting to print the pictures.
- Press [MENU/SET] to cancel printing halfway.
- Disconnect the USB connection cable after printing.

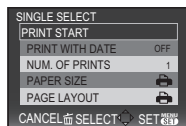

## Selecting multiple pictures and printing them

**1** Press **▲**.

**2** Press **▲/▼** to select an item and then press **[MENU/SET]**.

- If the print check screen has appeared, select [YES], and print the pictures.

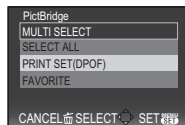

Item	Description of settings
[MULTI SELECT]	Multiple pictures are printed at one time. • Press ▲/▼/◀/▶ to select the pictures, and then When [DISPLAY] is pressed, [ ] appears on the pictures to be printed. (When [DISPLAY] is pressed again, the setting is canceled.) • After the pictures have been selected, press [MENU/SET].
[SELECT ALL]	Prints all the stored pictures.
[PRINT SET (DPOF)]	Prints the pictures set in [PRINT SET] only. (P172)
[FAVORITE]*	Prints the pictures set as favorites only. (P171)

\* Only when [FAVORITE] is at [ON] and when there are pictures set as favorites. (P171)

**3** Press **▲** to select **[PRINT START]** and then press **[MENU/SET]**.

- Refer to P192 for the items which can be set before starting to print the pictures.
- Press [MENU/SET] to cancel printing.
- Disconnect the USB connection cable after printing.

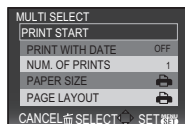

## Print Settings

Select and set the items both on the screen in step 2 of the “Selecting a single picture and printing it” and in step 3 of the “Selecting multiple pictures and printing them” procedures.

- When you want to print pictures on a paper size or a layout which is not supported by the camera, set [PAPER SIZE] or [PAGE LAYOUT] to [ ] and then set the paper size or the layout on the printer. (For details, refer to the instructions of the printer.)
- When [PRINT SET (DPOF)] has been selected, the [PRINT WITH DATE] and [NUM. OF PRINTS] items are not displayed.

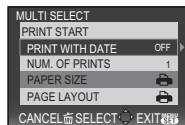

### [PRINT WITH DATE]

Item	Description of settings
[OFF]	Date is not printed.
[ON]	Date is printed.

- If the printer does not support date printing, the date cannot be printed on the picture.
- Since the printer's settings may take precedence over the Print With Date setting, check the printer's Print With Date setting as well.
- When printing images with a Text Stamp, please remember to set Print With Date to [OFF] or the date will print on top.

#### Note

**When asking the photo shop to print the pictures**

- By stamping the date using [TEXT STAMP] (P164) or setting date printing in [PRINT SET] (P172) before going to a photo shop, the dates can be printed at the photo shop.

### [NUM. OF PRINTS]

You can set the number of prints up to 999.





**[PAPER SIZE]**

Item	Description of settings
	Settings on the printer are prioritized.
[L/3.5"×5"]	89 mm×127 mm
[2L/5"×7"]	127 mm×178 mm
[POSTCARD]	100 mm×148 mm
[16:9]	101.6 mm×180.6 mm
[A4]	210 mm×297 mm
[A3]	297 mm×420 mm
[10×15cm]	100 mm×150 mm
[4"×6"]	101.6 mm×152.4 mm
[8"×10"]	203.2 mm×254 mm
[LETTER]	216 mm×279.4 mm
[CARD SIZE]	54 mm×85.6 mm

• Paper sizes not supported by the printer will not be displayed.



**[PAGE LAYOUT] (Layouts for printing that can be set with the camera)**

Item	Description of settings
	Settings on the printer are prioritized.
	1 picture with no frame on 1 page
	1 picture with a frame on 1 page
	2 pictures on 1 page
	4 pictures on 1 page

- An item cannot be selected if the printer does not support the page layout.

**■ Layout printing****When printing a picture several times on 1 sheet of paper**

For example, if you want to print the same picture 4 times on 1 sheet of paper, set [PAGE LAYOUT] to  and then set [NUM. OF PRINTS] to 4 for the picture that you want to print.

**When printing different pictures on 1 sheet of paper**

For example, if you want to print 4 different pictures on 1 sheet of paper, set [PAGE LAYOUT] to  and then set [NUM. OF PRINTS] to 1 for each of the 4 pictures.

**Note**

- The camera is receiving an error message from the printer when the  indication lights orange during printing. After finishing printing, make sure there are no problems with the printer.
- If the number of prints is high, the pictures may be printed several times. In this case, the remaining number of prints indicated may differ from the number set.
- When the pictures in RAW files are to be printed, the JPEG pictures recorded simultaneously by the camera will be printed. If JPEG pictures do not exit, RAW file pictures cannot be printed.

## Using the Electronic Viewfinder EVF1

When using the Electronic Viewfinder EVF1 (available as accessory, see [P7](#)), you can view the recording screen even when taking pictures with a low camera angle.

Preparations:

- Turn off the camera and close the built-in flash.
- Remove the hot shoe cover that is attached to the camera. ([P11](#))

### 1 Insert the Electronic Viewfinder EVF1 fully and securely into the hot shoe.

- Press the lower part of the Electronic Viewfinder EVF1 with your finger, and securely insert the connector as well.

(Do not press on the viewfinder part)

- (A) Hot shoe
- (B) Dedicated connector for external viewfinder
- (C) [EVF/LCD]
- (D) Finder

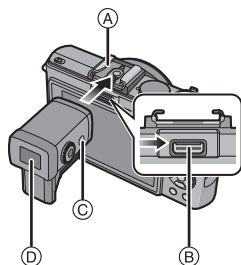

### 2 Switch [ON] the camera.

- [ ] is displayed on the LCD monitor. It may not be connected properly if it does not display.

### 3 Switch to and from the Electronic Viewfinder EVF1 by pressing [EVF/LCD].

- You can switch between LCD (LCD monitor) display and EVF (Viewfinder) display.
- Switching via the [EVF/LCD] button will be maintained even when the power of the digital camera is turned [OFF].
- When [PLAY ON LCD] is set to [ON] on the [SETUP] menu, the LCD monitor is automatically turned on when switching from Recording Mode to Playback Mode. ([P65](#))

### ■ To remove the Electronic Viewfinder EVF1

- 1 Switch the power [OFF].
- 2 Return the angle of the Electronic Viewfinder EVF1 to its original position if it has changed.
- 3 Pull in the direction of the arrow and remove.

- Reattach the hot shoe cover in its original position.

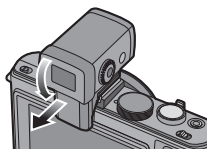

## ■ Diopter adjustment

Adjust the diopter to suit your vision so that you can see the Viewfinder clearly.

**Look at the display on the Viewfinder and rotate the diopter adjustment dial to where the screen is clearest.**

- (A) Diopter adjustment dial
- (B) [EVF/LCD]

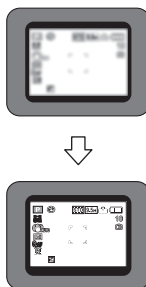
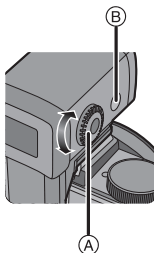

## ■ About the settings for recording with a low camera angle

Based on the camera angle, set the angle of the Electronic Viewfinder EVF1 for easy viewing (from approximately 0° to 90°).

Do not open beyond 90°. Doing so may cause damage.

- The light from the flash may be blocked when you take a picture using the flash with the Electronic Viewfinder EVF1 set at an angle.

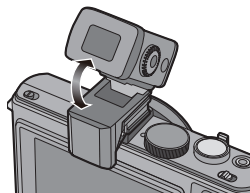

## Note

- When attaching and detaching the Electronic Viewfinder EVF1, be sure to do so slowly and carefully.
- The Electronic Viewfinder EVF1 cannot be used with the External Flash unit.
- When a shoulder strap is fitted, do not allow it to snag on the Electronic Viewfinder EVF1.
- When attaching the Electronic Viewfinder EVF1, do not hold only the Electronic Viewfinder EVF1 because it may detach from the camera.
- As the eye cup cannot be removed, gently wipe it with a dry and soft cloth, and be careful not to remove it.
- If you wipe the eye cup too hard and it is removed, consult the dealer or your nearest Service Center.
- For details, refer to the instructions of the Electronic Viewfinder EVF1.

## Using an external flash unit

After attaching an external flash unit such as the LEICA CF 22 (available as accessory, see P7), the effective range will be increased when compared to the camera's built in flash.

Preparations:

- Turn off the camera and close the built-in flash.
- Remove the hot shoe cover. (P11)

### ■ Using a dedicated flash unit

**1** Attach the flash unit to the hot shoe **A** and then turn it and the camera on.

- Be sure to push the flash unit's shoe completely into the camera's hot shoe.

**2** Select [FLASH] on the [REC] mode menu. (P28)

**3** Press **▲/▼** to select the mode and then press [MENU/SET].

- What screen will be displayed here depends on the flash mode setting of the external flash unit.

**4** Press [MENU/SET] to close the menu.

- You can also press the shutter button halfway to close the menu.
- While the external flash is connected, the following icons are displayed.

: External flash active

: External flash Forced OFF

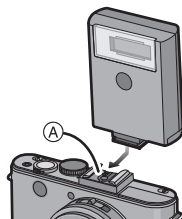

### ■ When using other commercially available external flashes without communication functions with the camera

- It is necessary to set the exposure on the external flash. If you want to use the external flash in Auto Mode, use an external flash that allows you to set the aperture value and the ISO sensitivity to match the settings on the camera.
- Set to Aperture-Priority Mode or Manual Exposure Mode on the camera and then set the same aperture value and ISO sensitivity on the external flash. (The exposure cannot be compensated adequately due to the change on the aperture value in Shutter-Priority Mode and the external flash cannot control the light adequately in Program mode because the aperture value cannot be fixed.)

 **Note**

- You can set the aperture value, the shutter speed and the ISO sensitivity on the camera even when attaching the external flash.
- Some commercial external flashes have synchro terminals with high-voltage or reversed polarity. Using such extra flashes may cause a malfunction or the camera may not operate normally.
- Do not use commercially available external flashes with communication functions other than the dedicated one. These flashes may not operate normally or they may be damaged.
- Even if the external flash is turned off, the camera may enter the external flash mode when the external flash is attached. When you are not using the external flash, detach it or set it to Forced OFF.
- When attaching the external flash, the built-in flash cannot be activated.
- Do not open the built-in flash when an external flash is attached.
- The camera will become unstable when attaching the external flash, it is recommended to use a tripod when taking picture.
- Turn off the camera when removing the external flash.
- Detach the external flash when carrying the camera.
- When attaching the external flash, do not hold only the external flash because it may detach from the camera.
- If you use the external flash when the white balance is set to [  ] finely adjust the white balance depending on the picture quality. (P132)
- If you take pictures close to the subject in Wide, the vignetting effect may appear on the bottom of the recorded picture.
- Either an external flash or the Electronic Viewfinder EVF1 (available as accessory, see P7) can be attached.
- Read the instructions of the external flash for details.

## Screen Display

### ■ In recording

#### Recording in Program Mode [P] (Initial setting)



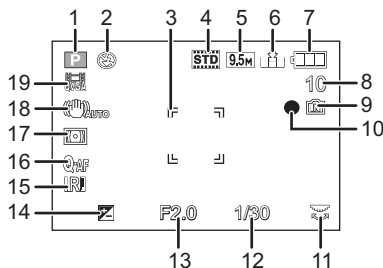

- 1 Recording Mode
- 2 Flash Mode (P67)
- 3 AF area (P46)
- 4 Film Mode (P124)
- 5 Resolution (P127)
- 6 Quality (P129)
- 7 Battery indication (P18)
- 8 Number of recordable pictures\*1 (P222)
- 9 ●: Focus (P46)
- 10 Internal memory (P23)
- 11 Card (P23) (displayed only during recording)
- 12 Recording state
- 13 Rear dial (P48, 59, 60, 77, 81, 82, 84, 111, 137)
- 14 ISO sensitivity (P130)
- 15 Shutter speed (P46)
- 16 Aperture value (P46)
- 17 Exposure compensation (P77)
- 18 Intelligent Resolution (P145)
- 19 Quick AF (P138)
- 20 Metering Mode (P140)
- 21 Optical Image Stabilizer (P146)
- 22 (([O])): Camera shake alert (P47)
- 23 REC MODE (when recording motion pictures) (P108)
- 24 Recording quality (P108)

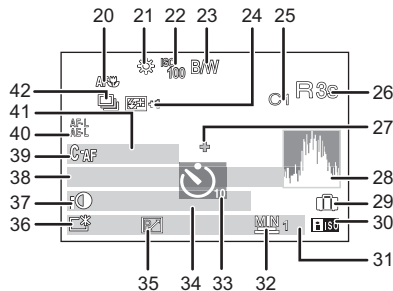

## ■ In recording (after settings)

- 20 AF macro recording (P73)  
 AF tracking (P136)  
 MF : MF (P84)  
 Wind cut (P152)
- 21 White Balance (P131)  
 White balance fine adjustment (P132)
- 22 ISO sensitivity (P130)  
 ISO Limit Set (P130)
- 23 Color Effect (P52)
- 24 Flash output adjustment (P71)
- 25 Custom settings (P90)
- 26 Available recording time  
 (P105): R1h2m30s<sup>\*2</sup>
- 27 Spot metering target (P140)
- 28 Histogram (P66)
- 29 Travel date (P119)  
 Elapsed recording time (P105)
- 30 Intelligent ISO (P130)  
 AF tracking operation (P51, 136)
- 31 Current date and time/📍: Travel destination setting (P122)<sup>\*3</sup>  
 Zoom/Extended Optical Zoom (P54)/Intelligent Zoom (P54, 145)  
 Digital Zoom (P54, 145):   
 Step Zoom (P57, 146): 
- 32 Minimum shutter speed (P143)
- 33 Self-Timer Mode (P74)
- 34 Age<sup>\*4</sup> (P98)  
 Location<sup>\*3</sup> (P119)  
 Focus range (P84)
- 35 Program Shift (P48)
- 36 LCD Mode (P32)
- 37 Intelligent Exposure (P140)



- 38 Name\*4 (P98)
- 39 Continuous AF (P138)
  - AF\*: AF assist lamp (P147)
  - AF.L: AF Lock (P139)
- 40 AF/AE LOCK (P139)
  - AE.L: AE Lock (P139)
- 41 Number of days that have passed since the departure date (P119)
- 42 Continuous mode (P144)
  - : Auto Bracket (P78)
  - : Aspect Bracket (P79)
  - : White Balance Bracket (P133)
  - : Multi exposure (P141)

\*1 [+99999] is displayed if there are more than 100000 pictures remaining.





\*2 "h" is an abbreviation for hour, "m" for minute and "s" for second.

\*3 This is displayed for about 5 seconds when the camera is turned on, after setting the clock and after switching from Playback Mode to Recording Mode.

\*4 This is displayed for about 5 seconds when the camera is turned on in [BABY1]/[BABY2] or [PET] in Scene Mode.



## ■ In playback

- 1 Playback Mode (P58)
- 2 Protected picture (P174)
- 3 Favorites (P171)
- 4 Stamped with text indication (P164)
- 5 Film Mode (P124)
- 6 Resolution (P129)
- 7 Quality (P129)
- 8 Battery indication (P18)
- 9 Folder/File number (P188)
- Internal memory (P23)
- Elapsed playback time (P159): 1h2m30s<sup>\*1</sup>
- 10 Picture number/Total pictures
- 11 Motion picture recording time (P159): 1h2m30s<sup>\*1</sup>
- 12 Histogram (P66)
- 13 Recording information (P64)
- 14 Favorites settings (P171)
- 15 Recorded date and time/World Time (P122)
- Name<sup>\*2</sup> (P98, 116)
- Location<sup>\*2</sup> (P119)
- Title<sup>\*2</sup> (P162)
- 16 Age (P98)
- 17 Number of days that have passed since the departure date (P119)
- 18 Power LCD (P32)
- 19 Color Effect (P52)
- 20 Number of prints (P172)
- 21  /  : Motion Picture Playback (P159)
-  /  : Recording quality (P108)
- Cable disconnection warning icon (P190)

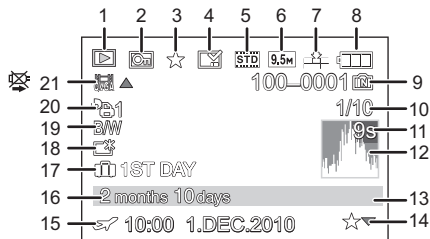

\*1 "h" is an abbreviation for hour, "m" for minute and "s" for second.

\*2 It is displayed in order of [TITLE], [LOCATION], [NAME] ([BABY1]/[BABY2], [PET]), [NAME] ([FACE RECOG.]).

## Cautions for Use

### Optimal use of the camera

**Keep the camera as far away as possible from electromagnetic equipment (such as microwave ovens, TVs, video games etc.).**

- If you use the camera on top of or near a TV, the pictures and/or sound on the camera may be disrupted by electromagnetic wave radiation.
- Do not use the camera near cell phones because doing so may result in noise adversely affecting the pictures and/or sound.
- Recorded data may be damaged, or pictures may be distorted, by strong magnetic fields created by speakers or large motors.
- Electromagnetic wave radiation generated by microprocessors may adversely affect the camera, disturbing the pictures and/or sound.
- If the camera is adversely affected by electromagnetic equipment and stops functioning properly, turn the camera off and remove the battery. Then reinsert the battery and turn the camera on.

**Do not use the camera near radio transmitters or high-voltage lines.**

- If you record near radio transmitters or high-voltage lines, the recorded pictures and/or sound may be adversely affected.

**Always use the supplied cords and cables. If you use optional accessories, use the cords and the cables supplied with them.**

**Do not extend the cords or the cables.**

**Do not spray the camera with insecticides or volatile chemicals.**

- If the camera is sprayed with such chemicals, the body of the camera may be damaged and the surface finish may peel off.
- Do not keep rubber or plastic products in contact with the camera for a long period of time.

### Care of the camera

- **Do not touch the lens or the sockets with dirty hands. Also, be careful not to allow liquids, sand and other foreign matter to get into the space around the lens, buttons etc.**
- **Do not strongly shake or bump the camera by dropping or hitting it. Do not subject to strong pressure.**

The camera may malfunction, recording pictures may become impossible, or the lens, the LCD monitor or the external case may be damaged.

- We strongly recommend you do not leave the camera in your trousers pocket when you sit down or forcefully insert it into a full or tight bag etc.

Damage to the LCD monitor or personal injury may result.

- **Be particularly careful in the following places as they may cause the camera to malfunction.**

– Places with a lot of sand or dust.

– Places where water can come into contact with the camera such as when using it on a rainy day or on a beach.

- **This camera is not waterproof. If water or seawater splashes on the camera, use a dry cloth to wipe the camera body carefully.**

**If the camera does not operate normally, please contact the dealer where you purchased the camera or the repair service center.**

- **The speaker does not have magnetic shielding. Do not keep this speaker and magnetized cards (bank cards, commuter passes, etc.) close together.**



### About Condensation (When the lens is fogged up)

- Condensation occurs when the ambient temperature or humidity changes. Be careful of condensation since it causes lens stains, fungus and camera malfunction.
- If condensation occurs, turn the camera off and leave it for about 2 hours. The fog will disappear naturally when the temperature of the camera becomes close to the ambient temperature.

## Cleaning

**Before cleaning the camera, remove the battery. Then wipe the camera with a dry soft cloth.**

- When the camera is soiled badly, it can be cleaned by wiping the dirt off with a wrung wet cloth, and then with a dry cloth.
- Do not use solvents such as benzine, thinner, alcohol, kitchen detergents, etc., to clean the camera, since it may deteriorate the external case or the coating may peel off.
- When using a chemical cloth, be sure to follow the accompanying instructions.

## About the LCD monitor/Electronic Viewfinder EVF1 (available as accessory, see [P7](#))

- Do not press the LCD monitor with excessive force. Uneven colors may appear on the LCD monitor and it may malfunction.
- If the camera is cold when you turn it on, the picture on the LCD monitor/Electronic Viewfinder EVF1 will be slightly darker than usual at first. However, the picture will return to normal brightness when the internal temperature of the camera increases.

Extremely high precision technology is employed to produce the LCD monitor/Electronic Viewfinder EVF1 screen. However, there may be some dark or bright spots (red, blue or green) on the screen. This is not a malfunction. The LCD monitor/Electronic Viewfinder EVF1 screen has more than 99.99% effective pixels with a mere 0.01% of the pixels inactive or always lit. The spots will not be recorded on pictures on the internal memory or a card.

## About the Lens

- Do not press against the lens with excessive force.
- Do not leave the camera with the lens facing the sun, as rays of light from the sun may cause it to malfunction. Also, be careful when placing the camera outside or near a window.

## Battery

The battery is a rechargeable lithium ion battery. Its ability to generate power comes from the chemical reaction that takes place inside it. This reaction is susceptible to the surrounding temperature and humidity. If the temperature is too high or too low, the operating time of the battery will become shorter.

**Always remove the battery after use.**

- Store the removed battery in the battery case (supplied).

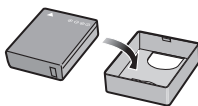

**If you drop the battery accidentally, check to see if the body of the battery and the terminals are damaged.**

- Inserting a damaged battery in the camera will damage the camera.

**Bring charged spare batteries when going out.**

- Be aware that the operating time of the battery becomes shorter in low temperature conditions such as at a ski resort.
- When you travel, do not forget to bring the charger (supplied) so that you can charge the battery in the country that you are traveling in.

**Dispose of unusable battery.**

- The battery has a limited life.
- Do not throw the battery into fire because it may cause an explosion.

**Do not allow battery terminals to come into contact with metal objects (such as necklaces, hairpins etc.).**

- This can cause short circuiting or heat generation and you may be badly burned if you touch a battery.

## Charger

- If you use the charger near a radio, the radio reception may be disturbed.
- Keep the charger 1 m or more away from radios.
- The charger may generate whirring sounds when it is being used. This is not a malfunction.
- After use, be sure to disconnect the power supply device from the electrical outlet. (A very small amount of current is consumed if it is left connected.)
- Keep the terminals of the charger and battery clean.

## Card

**Do not leave the card where the temperature is high, where electromagnetic waves or static electricity are easily generated or exposed to direct sunlight.**

**Do not bend or drop the card.**

- The card may be damaged or the recorded content may be damaged or deleted.
- Put the card in the card case or the storage bag after use and when storing or carrying the card.
- Do not allow dirt, dust or water to get into the terminals on the back of the card and do not touch the terminals with your fingers.

**Notice for when transferring to another party, or disposing of the memory card**

- “Format” or “delete” using the camera or a PC will only modify the file management information, and it will not erase the data in the memory card completely.

It is recommended to physically destroy the memory card or use the commercially available computer data deletion software to completely erase the data in the memory card before transferring to another party or disposing.

Management of data in the memory card is the responsibility of the user.

## About the personal information

If you record a user's name with [USER'S NAME REC] or set a name or birthday for [BABY1]/[BABY2] or the Face Recognition function, this personal information is kept in the camera and recorded in the image.

### Disclaimer

- Information including personal information may be altered or vanish due to erroneous operation, effect of static electricity, accident, malfunction, repair, or other handlings. Please note in advance that Leica is not liable in any way for any direct or indirect damage from the alteration or vanishing of information or personal information.

**When requesting a repair, transferring to another party or disposing**

- Reset the settings to protect the personal information. (P37)
- If there are pictures stored in the internal memory, copy them into the memory card (P176) before formatting the internal memory (P40) as needed.
- Remove the memory card from the camera when requesting a repair.
- Internal memory and settings may return to factory default when camera is repaired.
- Please contact the dealer where you purchased the camera or your nearest Service Center if above operations are not possible due to malfunction.

**When transferring to another party, or disposing of the memory card, please refer to “Notice for when transferring to another party, or disposing of the memory card” on P207.**

### When not using the camera for a long period of time

- Store the battery in a cool and dry place with a relatively stable temperature: [Recommended temperature: 15 °C to 25 °C (59 °F to 77 °F), Recommended humidity: 40%RH to 60%RH]
- Always remove the battery and the card from the camera.
- If the battery is left inserted in the camera, it will discharge even if the camera is turned off. If the battery continues to be left in the camera, it will discharge excessively and may become unusable even if charged.
- When storing the battery for a long period of time, we recommend charging it once a year. Remove the battery from the camera and store it again after it has completely discharged.
- We recommend storing the camera with a desiccant (silica gel) when you keep it in a closet or a cabinet.

### About the picture data

- Recorded data may be damaged or lost if the camera breaks down due to inappropriate handling. Leica Camera AG will not be liable for any damage suffered due to loss of recorded data.

### About tripods or unipods

- When you use a tripod, make sure the tripod is stable when the camera is attached to it.
- You may not be able to remove the card or the battery when using a tripod or unipod.
- Make sure that the screw on the tripod or unipod is not at an angle when attaching or detaching the camera. You may damage the screw on the camera if you use excessive force when turning it. Also, the camera body and the rating label may be damaged or scratched if the camera is attached too tightly to the tripod or unipod.
- Read the instructions for the tripod or unipod carefully.
- Some tripods or unipods may block the speaker, making it difficult to hear operating sounds etc.

## Message Display

Confirmation messages or error messages will be displayed on the LCD monitor/the Electronic Viewfinder EVF1 (available as accessory, see P7) in some cases.

The major messages are described below as examples.

### [THIS MEMORY CARD IS WRITE-PROTECTED]

- The Write-Protect switch on the card is moved to [LOCK]. Move the switch back to unlock it. (P24)

### [NO VALID PICTURE TO PLAY]

- Record a picture or insert a card with a recorded picture and then play it.

### [THIS PICTURE IS PROTECTED]

- Delete the picture after canceling the protect setting. (P174)

### [THIS PICTURE CANNOT BE DELETED]/[SOME PICTURES CANNOT BE DELETED]

- Pictures not based on the DCF standard cannot be deleted.
  - If you want to delete some pictures, format the card after saving necessary data on a PC etc. (P40)

### [NO ADDITIONAL SELECTIONS CAN BE MADE]

- The number of pictures, which can be set at one time when [MULTI] has been selected for [DELETE MULTI] (P63), [FAVORITE] (P171), [TITLE EDIT] (P162), [TEXT STAMP] (P164) or [RESIZE] (P167) has been exceeded.
  - Reduce the number of pictures set, and then repeat the operation.
- More than 999 favorites have been set.

### [CANNOT BE SET ON THIS PICTURE]

- [TITLE EDIT], [TEXT STAMP] or [PRINT SET] cannot be set for pictures not based on the DCF standard.

### [NOT ENOUGH SPACE ON BUILT-IN MEMORY]/[NOT ENOUGH MEMORY ON THE CARD]

- There is no space left on the internal memory or the card.
  - When you copy pictures from the internal memory to the card (batch copy), the pictures are copied until the capacity of the card becomes full.

### [SOME PICTURES CANNOT BE COPIED]/[COPY COULD NOT BE COMPLETED]

- The following pictures cannot be copied.
  - When a picture with the same name as the picture to be copied exists in the copy destination. (Only when copying from a card to the internal memory.)
  - Files not based on the DCF standard.
- Moreover, pictures recorded or edited by other equipment may not be copied.



### **[BUILT-IN MEMORY ERROR FORMAT BUILT-IN MEMORY?]**

- This message will be displayed when you format the internal memory on a PC.  
→ Format the internal memory on the camera again. (P40) The data on the internal memory will be deleted.

### **[MEMORY CARD ERROR FORMAT THIS CARD?]**

- It is a format that cannot be used with the camera.  
→ Format the card again with the camera after saving necessary data on a PC etc. (P40)

### **[PLEASE TURN CAMERA OFF AND THEN ON AGAIN]/[SYSTEM ERROR]**

- This message appears when the camera is not operating properly.  
→ Turn the camera off and on. If the message persists, contact the dealer or your nearest Service Center.

### **[MEMORY CARD PARAMETER ERROR]/[THIS MEMORY CARD CANNOT BE USED]**

- Use a card compatible with the camera. (P24)
- SD Memory Card (8 MB to 2 GB)
- SDHC Memory Card (4 GB to 32 GB)
- SDXC Memory Card (48 GB, 64 GB)

### **[INSERT SD CARD AGAIN]/[TRY ANOTHER CARD]**

- An error has occurred accessing the card.  
→ Insert the card again.  
→ Insert a different card.

### **[READ ERROR/WRITE ERROR PLEASE CHECK THE CARD]**

- It has failed to read or write data.  
→ Remove the card after turning the power [OFF]. Insert the card again, turn the power on, and try to read or write the data again.
- The card may be broken.  
→ Insert a different card.

### **[MOTION RECORDING WAS CANCELLED DUE TO THE LIMITATION OF THE WRITING SPEED OF THE CARD]**

- Use a card with SD Speed Class\* with "Class 4" or higher when recording motion pictures in [AVCHD Lite].  
Also, use a card with SD Speed Class with "Class 6" or higher when recording motion pictures in [MOTION JPEG].  
\* SD Speed Class is the speed standard regarding continuous writing.
- In the event that it stops even after using a "Class 4" card or higher, the data writing speed has deteriorated so it is recommended to make a backup and then format (P40).
- Depending on the type of the card, motion picture recording may stop in the middle.

**[THIS CARD IS NOT FORMATTED WITH THIS CAMERA, AND NOT SUITABLE FOR MOVIE RECORDING.]**

- The writing speed is lower if the card has been formatted using a PC or other equipment. As a consequence, motion picture recording may stop in the middle. If this happens, make a backup of the data and format (P40) the card in the camera.

**[CANNOT RECORD DUE TO INCOMPATIBLE FORMAT(NTSC/PAL) DATA ON THIS CARD.]**

- If you want to delete some pictures, format the card after saving necessary data on a PC etc. (P40)
- Insert a different card.

**[A FOLDER CANNOT BE CREATED]**

- A folder cannot be created because there are no remaining folder numbers that can be used. (P188)
  - Format the card after saving necessary data on a PC etc. (P40) If you execute [NO.RESET] in the [SETUP] menu after formatting, the folder number is reset to 100. (P36)

**[PICTURE IS DISPLAYED FOR 16:9 TV]/[PICTURE IS DISPLAYED FOR 4:3 TV]**

- The AV cable is connected to the camera.
  - Press [MENU/SET] if you want to delete this message at once.
  - Select [TV ASPECT] in the [SETUP] menu if you want to change the TV aspect. (P37)
- This message also appears when the USB connection cable is connected to the camera only. In this case, connect the other end of the USB connection cable to a PC or a printer. (P186, 189)

**[PRINTER BUSY]/[PLEASE CHECK THE PRINTER]**

- The printer cannot print.
  - Check the printer.

**[NO BATTERY POWER REMAINS]**

- The remaining battery power is low.
  - Charge the battery.

**[THIS BATTERY CANNOT BE USED]**

- The battery cannot be recognized by the camera.
  - Use only a Leica battery BP-DC10 (P7). If this message is displayed even when a Leica battery BP-DC10 battery is used, contact your Leica dealer or the nearest Leica Customer Service Center.
- The battery cannot be recognized as its terminal is dirty.
  - Remove any dirt etc. from the terminal.

## Troubleshooting

First, try out the following procedures (P212–221).

If the problem is not resolved, it may be improved by selecting [RESET] (P37) on the [SETUP] menu when taking pictures.

### Battery and power source

#### The camera cannot be operated even when it is turned on.

- The battery is not inserted correctly. (P21)
- The battery is exhausted. Charge the battery.

#### The LCD monitor turns off while the camera is turned on.

- Is the [MONITOR MODE] (P149) set to [ON]?  
→ Press [DISPLAY] to switch to the LCD monitor.
- Does the Electronic Viewfinder EVF1 (available as accessory, see P7) display an image?  
→ Switch to LCD monitor display by pressing [EVF/LCD] on the Viewfinder. (P195)
- Is [AUTO LCD OFF] (P35) of the [ECONOMY] Mode active?  
→ Press the shutter button halfway to cancel this mode.
- The battery is exhausted. Charge the battery.

#### The camera turns off immediately after it is turned on.

- The battery is exhausted. Charge the battery.
- If you leave the camera on, the battery will be exhausted.  
→ Turn the camera off frequently by using the [ECONOMY] Mode etc. (P35)

#### This camera is turned off automatically.

- If you connect to a TV compatible with HDTV Link with the optionally available HDMI mini cable and turn off the power on the TV with the remote control for the TV, the power on the camera also turns off.  
→ If you are not using HDTV Link, set [HDTV Link] to [OFF]. (P38)

#### The [CHARGE] lamp flashes.

- Is the temperature of the battery excessively high or low? If it is, it will take longer than usual to charge the battery or charging may remain incomplete.
- Are the terminals of the charger or battery dirty?  
→ Wipe off the dirt using a dry cloth.

## Recording

**The picture cannot be recorded.**

- Is the mode dial correctly set?
- Is there any memory remaining on the internal memory or the card?
  - Delete the pictures which are not necessary to increase the available memory. (P62)

**The recorded picture is whitish.**

- The picture can become whitish if there is dirt e.g. fingerprints on the lens.
  - If the lens is dirty, turn on the camera, eject the lens barrel (P9) and gently wipe the lens surface with a soft dry cloth.

**The area around where the pictures were taken becomes dark.**

- Was this picture taken with the flash at the close range when the zoom was near [W] (1×)?
  - Zoom in a little, and then take the pictures. (P54)
- Was this a picture taken in [PIN HOLE] in My Color Mode?

**The recorded picture is too bright or dark.**

- Check that the exposure is correctly compensated. (P77)
- Setting the [MIN. SHTR SPEED] to faster speed might make the picture darker.
  - Set the [MIN. SHTR SPEED] (P143) to slower speed.

**Multiple pictures are taken at one time.**

- Unset the settings of [MULTI FILM] (P126) or White Balance Bracket (P133).
- Set [AUTO BRACKET] (P78), [ASPECT BRACKET] (P79) or [BURST] (P144) to [OFF].
- Has [HI-SPEED BURST] (P100) or [FLASH BURST] (P101) in Scene Mode been set?

**The subject is not focused properly.**

- The focus range varies depending on the Recording Mode.
  - Set to the proper mode for the distance to the subject.
- The subject is beyond the focus range of the camera. (P45)
- There is camera shake or the subject is moving slightly. (P47)

**The recorded picture is blurred.****The Optical Image Stabilizer is not effective.**

- The shutter speed becomes slower when pictures are taken in dark places so hold the camera firmly with both hands to take the pictures. (P43)
- When taking pictures at a slow shutter speed, use the Self-Timer. (P74)

### Taking pictures using [AUTO BRACKET]/[ASPECT BRACKET]/White Balance Bracket is not possible.

- Is the number of recordable pictures 2 or less?

### The recorded picture looks rough. Noise appears on the picture.

- Is the ISO sensitivity high or the shutter speed slow? (ISO sensitivity is set to [AUTO] when the camera is shipped. Therefore, when taking pictures indoors etc. noise will appear.)
  - Decrease the ISO sensitivity. (P130)
  - Increase the setting for [NOISE REDUCTION] in [FILM MODE] or lower the setting for each of the items other than [NOISE REDUCTION]. (P125)
  - Take pictures in bright places.
- Has [HIGH SENS.] or [HI-SPEED BURST] in the Scene Mode been set? If so, the resolution of the recorded picture decreases slightly because of high sensitivity processing, but this is not a malfunction.

### The brightness or the hue of the recorded picture is different from the actual scene.

- If recording under fluorescent light, the brightness or the hue may change slightly when the shutter speed becomes fast. This occurs due to the characteristics of fluorescent light. It is not a malfunction.

### When recording pictures or half-pressing the shutter button, reddish stripes may appear on the LCD monitor. Alternatively, part or all of the LCD monitor may turn a reddish color.

- This is a characteristic of CCDs, and it appears when the subject has a bright part. Some unevenness may occur in the surrounding areas, but this is not a malfunction. It is recorded in motion pictures but is not recorded on still pictures.
- It is recommended that you take pictures while taking care not to expose the screen to sunlight or any other source of strong light.



### Motion picture recording stops in the middle.

- Use a card with SD Speed Class\* with "Class 4" or higher when recording motion pictures in [AVCHD Lite]. Also, use a card with SD Speed Class with "Class 6" or higher when recording motion pictures in [MOTION JPEG].
  - \* SD Speed Class is the speed standard regarding continuous writing.
- Depending on the type of the card, recording may stop in the middle.
  - If motion picture recording stops during use of a card of at least "Class 4" or if you use a card that has been formatted on a PC or other equipment, the data-writing speed is lower. In such cases, we recommend that you make a backup of the data and then format (P40) the card in the camera.

**Zoom does not operate properly.**

- Is the [STEP ZOOM] (P146) set to [ON]?

**The subject cannot be locked. (AF track fails)**

- Set the AF area to the distinctive color of the subject if there is a part that is different from the surrounding color. (P136)

**Lens****Recorded image may be warped, or nonexistent color is surrounding the subject.**

- It is possible that the subject may be warped slightly, or the borders get colored, depending on the zoom magnification, due to the characteristics of the lens. Also, the peripherals of the image might look warped because the perspective is enhanced when the wide angle is used. This is not a malfunction.

**LCD monitor/Electronic Viewfinder EVF1  
(available as accessory, see P7)****The LCD monitor turns off although the camera is turned on.**

- The LCD monitor turns off and the status indicator lights when [AUTO LCD OFF] (P35) of the [ECONOMY] Mode is activated.

**The LCD monitor/Electronic Viewfinder EVF1 (available as accessory, see P7) becomes darker or brighter for a moment.**

- This phenomenon appears when you press the shutter button halfway to set the aperture value and does not affect the recorded pictures.
- This phenomenon also appears when the brightness changes when the camera is zoomed or when the camera is moved. This is because of operation of the automatic aperture of the camera, and it is not a malfunction.

**The LCD monitor flickers indoors.**

- The LCD monitor may flicker for a few seconds after turning the camera on indoors under fluorescent light. This is not a malfunction.

**The LCD monitor is too bright or dark.**

- [POWER LCD] is activated. (P32)

**The picture is not displayed on the LCD monitor.**

- Is the [MONITOR MODE] (P149) set to [ON]?  
→ Press [DISPLAY] to switch to the LCD monitor.
- Does the picture appear on the Electronic Viewfinder EVF1 (available as accessory, see P7)?  
→ Switch to LCD monitor display by pressing [EVF/LCD] on the Viewfinder. (P195)

**The picture does not switch between LCD monitor and Electronic Viewfinder EVF1 (available as accessory, see P7) when [EVF/LCD] is pressed on the Viewfinder.**

- It is only displayed on the LCD monitor when the camera is connected to a PC or printer.

**Black, red, blue and green dots appear on the LCD monitor.**

- This is not a malfunction.  
These pixels do not affect the recorded pictures.

**Noise appears on the LCD monitor.**

- In dark places, noise may appear to maintain the brightness of the LCD monitor. This does not affect the pictures you are recording.

**You see red, green, or blue flashes when you move your eyes in the Electronic Viewfinder EVF1 (available as accessory, see P7), or when the camera is moved rapidly.**

- This is a characteristic of the viewfinder's drive system, and it is not a malfunction. There will be no problem with the recorded image.

**Flash****The flash is not activated.**

- Is the flash closed?  
→ Open the flash by sliding [⚡ OPEN]. (P67)
- Flash Mode is not available when [AUTO BRACKET] (P78), [MULTI FILM] (P126) or [BURST] (P144) has been set.

**Flash is activated several times.**

- The flash is activated twice when Red-Eye Reduction (P68) has been set.
- Has [FLASH BURST] (P101) in Scene Mode been set?

## Playback

**The picture being played back is rotated and displayed in an unexpected direction.**

- [ROTATE DISP.] (P170) is set to [ON].

**The picture is not played back.  
There are no recorded pictures.**

- Did you press [▶]?
- Is there a picture on the internal memory or the card?  
→ The pictures on the internal memory appear when a card is not inserted. The picture data on the card appears when a card is inserted.
- Is this a picture whose file name has been changed in the PC? If it is, it cannot be played back by the camera.
- Has [MODE PLAY], [CATEGORY PLAY] or [FAVORITE PLAY] been set for playback?  
→ Change to [NORMAL PLAY]. (P58)

**The folder number and the file number are displayed as [—] and the screen turns black.**

- Is this a non-standard picture, a picture which has been edited using a PC or a picture which was taken by another make of digital camera?
- Did you remove the battery immediately after picture-taking or did you take the picture using a battery with a low remaining charge?  
→ Format the data to delete the pictures mentioned above. (P40)  
(Other pictures will be deleted as well and it will not be possible to restore them. Therefore, check well before formatting.)

**With a Calendar Search, pictures are displayed on dates differing from the actual dates on which the pictures were taken.**

- Is the clock in the camera set properly? (P25)
- When pictures edited using a PC or pictures taken by other equipment are searched, they may be displayed on dates differing from the actual dates on which the pictures were taken.







**White round spots like soap bubbles appear on the recorded picture.**

- If you take a picture with the flash in a dark place or indoors, white round spots may appear on the picture caused by the flash reflecting of particles of dust in the air. This is not a malfunction. A characteristic of this is that the number of round spots and their position differ in every picture.





**Red part of the recorded image has changed color to black.**

- When Digital Red-Eye Correction ([, [, []) is in operation, if you take a picture of a subject with red color surrounded by a skin tone color, that red part may be corrected to black by the Digital Red-Eye Correction function.
  - It is recommend to take the picture with Flash Mode set to [, [] or [, or [RED-EYE REMOVAL] on the [REC] Mode menu set to [OFF]. (P149)

**[THUMBNAIL IS DISPLAYED] appears on the screen.**

- Is it a picture that has been recorded with other equipment? In such cases, these pictures may be displayed with a deteriorated picture quality.

**A clicking sound is recorded in the motion pictures.**

- This camera automatically adjusts the aperture during motion picture recording. At such times, a clicking sound is heard, and this sound may be recorded on the motion pictures. This is not a malfunction.

**TV, PC and printer****The picture does not appear on the television.**

- Is the camera connected to the TV correctly?
  - Set the TV input to External Input Mode.
- Output from the [HDMI] socket is not possible when the camera is connected to a PC or a printer.
  - Connect the camera only to the TV.

**The display areas on the TV screen and the camera's LCD monitor are different.**

- Depending on the TV model, the pictures may be extended horizontally or vertically or they may be displayed with their edges cut off.

**The motion pictures cannot be played back on a TV.**

- Are you trying to play back the motion pictures by directly inserting the card in the card slot of the TV?
  - Connect the camera to the TV with the AV cable (supplied), or with the HDMI mini cable (available as accessory, see P7), and then play back the motion pictures on the camera. (P177, 178)
  - Motion pictures recorded in [AVCHD Lite] can be played back on televisions with the AVCHD logo.

**The picture is not displayed fully on the TV.**

- Check [TV ASPECT] setting. (P37)

**HDTV Link does not work.**

- Is it connected properly with the HDMI mini cable (available as accessory, see P7)? (P178)
  - Confirm that the HDMI mini-cable is attached correctly.
  - Press [▶] on the camera.
- Is the [HDTV Link] on the camera set to [ON]? (P38)
  - Depending on HDMI terminal of the TV, the input channel may not switch automatically. In this case, use the remote control for the TV to switch input. (For details on how to switch input, please read the instructions for the TV.)
  - Check the HDTV Link setting on the connected device.
  - Turn the power to the camera off and then back on again.
  - Set [HDTV Link] to [Off] on the TV and then turn it back to [On]. (Refer to the operating instructions of the TV for details.)
  - Check [VIDEO OUT] setting. (P37)

**The picture cannot be transferred when the camera is connected to a PC.**

- Is the camera connected to the PC correctly?
- Is the camera recognized by the PC correctly?
  - Set to [PC] in [USB MODE]. (P37, 186)

**The card is not recognized by the PC. (The internal memory is recognized.)**

- Disconnect the USB connection cable. Connect it again while the card is inserted in the camera.

**The card is not recognized by the PC. (SDXC memory card is used)**

- Check if your PC is compatible with SDXC memory cards.
- A message prompting to format the card may be displayed when connecting, but do not format.
- If the [ACCESS] displayed on the LCD monitor does not disappear, disconnect the USB connection cable after turning off the power.

**The picture cannot be printed when the camera is connected to a printer.**



- Pictures cannot be printed using a printer which does not support PictBridge.
  - Set to [PictBridge(PTP)] in [USB MODE]. (P37, 189)

**The ends of the pictures are cut at printing.**

- When using a printer with a Cropping or borderless printing function, cancel this function before printing. (For details, refer to the instructions for the printer.)
- When you order photo studios to print pictures, ask the photo studio if the pictures can be printed with both ends.

## Others

### An unreadable language was selected by mistake.

→ Press [MENU/SET], select the [SETUP] menu icon [] and then select the [] icon to set the desired language. (P40)

### Part of the picture is flashing in black and white.

- This is a highlight function showing the white saturated area. (P34)
- Is the [HIGHLIGHT] set to [ON]?

### A red lamp sometimes turns on when the shutter button is pressed halfway.

- In dark places, the AF Assist Lamp (P147) lights red to make it easier to focus on a subject.

### The AF Assist Lamp does not turn on.

- Is [AF ASSIST LAMP] on the [REC] Mode menu set to [ON]? (P147)
- The AF Assist Lamp does not turn on in bright places.

### The camera becomes warm.

- The surface of the camera may become warm during use. This does not affect the performance or quality of the camera.

### The lens clicks.

- When the brightness changes due to zoom or camera movement etc., the lens may click and the picture on the screen may drastically change. However, the picture is not affected. The sound is caused by the automatic adjustment of the aperture. This is not a malfunction.

### The clock is reset.

- If you do not use the camera for a long time, the clock may be reset.  
→ [PLEASE SET THE CLOCK] message will be displayed; please re-set the clock. When taking pictures, it will not be possible to record the correct date without setting the clock. (P25)

### When pictures are taken using the zoom, they are slightly distorted and the areas around the subject contain colors which are not actually present.

- It is possible that the subject may be warped slightly, or the borders get colored, depending on the zoom magnification, due to the characteristics of the lens, but this is not a malfunction.

### Zooming stops instantaneously.

- When using the Extended Optical Zoom or the Intelligent Zoom, the zooming action will stop temporarily. This is not a malfunction.

**The file numbers are not recorded consecutively.**

- When you perform an operation after taking a certain action, the pictures may be recorded in folders with different numbers from the ones used prior to the operation. (P188)

**The file numbers are recorded in ascending order.**

- If the battery was inserted or removed without first turning the camera's power off, the folder and file numbers for the pictures taken will not be stored in the memory. When the power is then turned back on and pictures are taken, they may be stored under file numbers which should have been assigned to previous pictures.

**[AGE] is not displayed correctly.**

- Check the clock (P25) and birthday settings (P98).

**The lens barrel is retracted.**









- The lens barrel retracts about 15 seconds after switching from [REC] Mode to [PLAYBACK] Mode.









## Number of Recordable Pictures and Available Recording Time





- The number of recordable pictures and the available recording time are an approximation. (These vary depending on the recording conditions and the type of card.)
- The number of recordable pictures and the available recording time varies depending on the subjects.

### ■ Number of recordable pictures

- [+99999] is displayed if there are more than 100000 pictures remaining.









Aspect ratio		1:1								
Resolution		7.5M				5.5M (7.2)				
Quality				RAW 	RAW 	RAW			RAW 	RAW 
Internal Memory (Approx. 40 MB)		12	20	2	3	4	15	26	2	3
Card	512 MB	140	220	37	41	51	165	290	38	43
	1 GB	280	440	75	83	100	330	580	78	87
	2 GB	580	900	150	170	200	680	1180	160	175
	4 GB	1140	1770	300	330	410	1340	2320	310	350
	6 GB	1740	2690	460	510	620	2030	3520	480	530
	8 GB	2330	3610	610	680	840	2720	4720	640	710
	12 GB	3520	5440	930	1030	1260	4110	7120	970	1070
	16 GB	4700	7260	1240	1370	1690	5490	9500	1290	1440
	24 GB	6830	10550	1810	1990	2450	7970	13790	1880	2090
	32 GB	9440	14570	2500	2760	3390	11010	19060	2600	2880
	48 GB	13490	21420	3670	4040	4980	15830	28020	3790	4230
64 GB	18300	29070	4990	5490	6770	21490	38020	5140	5740	









Aspect ratio		1:1							
Resolution		35M (EZ)				25M (EZ)			
Quality				RAW 	RAW 			RAW 	RAW 
Internal Memory (Approx. 40 MB)		18	35	3	3	37	74	3	3
Card	512 MB	200	380	40	44	400	790	45	47
	1 GB	400	770	82	90	810	1580	91	96
	2 GB	820	1570	165	180	1660	3230	185	195
	4 GB	1630	3090	320	360	3260	6350	360	380
	6 GB	2470	4700	500	550	4950	9650	550	580
	8 GB	3310	6290	670	740	6630	12920	740	780
	12 GB	5000	9490	1010	1110	10010	19490	1120	1190
	16 GB	6670	12670	1350	1490	13350	26000	1500	1580
	24 GB	9690	18390	1960	2160	19390	37760	2180	2300
	32 GB	13390	25410	2710	2990	26790	52170	3010	3180
	48 GB	19170	36420	3950	4380	36420	72850	4380	4660
64 GB	26010	49430	5370	5950	49430	98860	5950	6330	

Aspect ratio		1:1			
Resolution		0.2M (EZ)			
Quality				RAW 	RAW 
Internal Memory (Approx. 40 MB)		310	470	4	4
Card	512 MB	3350	5030	50	50
	1 GB	6710	10070	100	100
	2 GB	12290	20480	200	200
	4 GB	24130	40220	400	400
	6 GB	36700	61160	610	620
	8 GB	49120	81870	820	830
	12 GB	74090	123490	1250	1250
	16 GB	98830	164730	1660	1680
	24 GB	143510	239180	2420	2430
	32 GB	198260	330440	3340	3370
	48 GB	182130	364270	4920	4920
	64 GB	247150	494310	6670	6670









Aspect ratio		4:3								
Resolution		10M					7M (EZ)			
Quality				RAW 	RAW 	RAW			RAW 	RAW 
Internal Memory (Approx. 40 MB)		9	15	1	2	2	12	20	2	2
Card	512 MB	110	165	28	30	37	135	220	29	32
	1 GB	220	330	56	62	76	270	440	59	65
	2 GB	450	680	115	125	155	560	900	120	130
	4 GB	890	1340	220	250	300	1110	1770	240	260
	6 GB	1360	2030	340	380	460	1690	2690	360	390
	8 GB	1830	2720	460	500	620	2270	3610	490	530
	12 GB	2760	4110	700	760	940	3420	5440	740	800
	16 GB	3680	5490	940	1020	1260	4570	7260	980	1070
	24 GB	5350	7970	1360	1490	1830	6640	10550	1430	1560
	32 GB	7390	11010	1880	2060	2530	9170	14570	1980	2150
	48 GB	10710	15830	2750	3000	3710	13490	21420	2910	3160
64 GB	14530	21490	3740	4080	5040	18300	29070	3950	4290	









Aspect ratio		4:3							
Resolution		5M (EZ)				3M (EZ)			
Quality				RAW 	RAW 			RAW 	RAW 
Internal Memory (Approx. 40 MB)		14	26	2	2	18	36	2	2
Card	512 MB	160	290	30	33	200	390	31	34
	1 GB	320	580	61	67	400	790	64	69
	2 GB	660	1180	125	135	820	1610	130	140
	4 GB	1310	2320	240	270	1630	3170	250	280
	6 GB	1990	3520	370	410	2470	4820	390	420
	8 GB	2660	4720	500	550	3310	6460	520	570
	12 GB	4020	7120	760	830	5000	9740	790	860
	16 GB	5370	9500	1020	1110	6670	13000	1060	1150
	24 GB	7790	13790	1480	1610	9690	18880	1540	1670
	32 GB	10770	19060	2050	2230	13390	26080	2130	2310
	48 GB	15830	28020	3000	3280	19170	36420	3110	3370
64 GB	21490	38020	4080	4450	26010	49430	4220	4570	









Aspect ratio		4:3							
Resolution		2M (EZ)				0.3M (EZ)			
Quality				RAW 	RAW 			RAW 	RAW 
Internal Memory (Approx. 40 MB)		46	88	2	2	230	400	2	2
Card	512 MB	490	940	35	36	2510	4310	37	37
	1 GB	990	1880	70	73	5030	8630	75	75
	2 GB	1980	3840	140	150	10240	15360	150	150
	4 GB	3890	7540	280	290	20110	30170	300	300
	6 GB	5910	11460	430	450	30580	45870	460	460
	8 GB	7920	15350	580	600	40930	61400	610	620
	12 GB	11950	23150	870	900	61740	92610	930	930
	16 GB	15940	30880	1170	1210	82360	123540	1240	1250
	24 GB	23140	44840	1690	1760	119590	179380	1800	1810
	32 GB	31970	61950	2340	2430	165220	247830	2490	2500
48 GB	45530	91060	3430	3570	182130	364270	3640	3670	
64 GB	61780	123570	4660	4840	247150	494310	4940	4990	









Aspect ratio		3:2								
Resolution		9.5M				6.5M (EZ)				
Quality				RAW 	RAW 	RAW			RAW 	RAW 
Internal Memory (Approx. 40 MB)		10	15	2	2	3	12	20	2	2
Card	512 MB	110	170	29	33	41	135	220	31	34
	1 GB	220	340	60	66	83	270	450	63	70
	2 GB	460	690	120	135	165	560	910	130	140
	4 GB	910	1370	240	260	330	1100	1800	250	280
	6 GB	1380	2080	370	400	500	1680	2730	390	430
	8 GB	1850	2790	490	540	680	2250	3660	520	570
	12 GB	2800	4200	750	820	1020	3390	5520	790	860
	16 GB	3740	5610	1000	1100	1370	4530	7370	1050	1150
	24 GB	5430	8150	1450	1600	1990	6580	10700	1530	1680
	32 GB	7500	11260	2010	2210	2750	9090	14790	2110	2320
	48 GB	11030	16550	2960	3250	4040	13000	21420	3110	3400
64 GB	14970	22460	4010	4410	5490	17650	29070	4220	4610	











Aspect ratio		3:2							
Resolution		4.5M (74)				3M (74)			
Quality				RAW 	RAW 			RAW 	RAW 
Internal Memory (Approx. 40 MB)		14	26	2	2	18	36	2	2
Card	512 MB	160	290	32	36	200	390	34	37
	1 GB	320	580	66	72	400	780	68	75
	2 GB	660	1180	135	145	810	1570	140	150
	4 GB	1290	2320	260	290	1600	3090	270	300
	6 GB	1970	3520	400	440	2440	4700	420	460
	8 GB	2640	4720	540	590	3270	6290	560	610
	12 GB	3980	7120	810	900	4930	9490	850	930
	16 GB	5310	9500	1090	1200	6580	12670	1130	1240
	24 GB	7710	13790	1580	1740	9560	18390	1650	1800
	32 GB	10650	19060	2190	2410	13210	25410	2280	2490
48 GB	15170	28020	3220	3530	19170	36420	3340	3640	
64 GB	20590	38020	4370	4790	26010	49430	4530	4940	







Aspect ratio		3:2							
Resolution		25M (74)				0.3M (74)			
Quality				RAW 	RAW 			RAW 	RAW 
Internal Memory (Approx. 40 MB)		19	37	2	2	250	400	3	3
Card	512 MB	210	400	34	37	2740	4310	40	40
	1 GB	420	810	69	75	5490	8630	82	82
	2 GB	850	1660	140	150	10240	15360	165	165
	4 GB	1670	3260	270	300	20110	30170	320	330
	6 GB	2540	4950	420	460	30580	45870	500	500
	8 GB	3410	6630	560	610	40930	61400	670	670
	12 GB	5140	10010	850	930	61740	92610	1010	1010
	16 GB	6860	13350	1140	1240	82360	123540	1350	1360
	24 GB	9960	19390	1660	1810	119590	179380	1960	1970
	32 GB	13760	26790	2290	2500	165220	247830	2710	2730
	48 GB	20230	36420	3370	3670	182130	364270	3950	4000
64 GB	27460	49430	4570	4990	247150	494310	5370	5430	

Aspect ratio		16:9								
Resolution		9 M				6 M (37)				
Quality				RAW 	RAW 	RAW			RAW 	RAW 
Internal Memory (Approx. 40 MB)		10	15	2	2	3	12	21	2	2
Card	512 MB	115	175	31	35	44	135	220	33	36
	1 GB	230	350	64	71	89	270	460	67	74
	2 GB	470	710	130	145	180	550	930	135	150
	4 GB	920	1400	250	280	350	1080	1820	260	300
	6 GB	1410	2130	390	430	540	1650	2770	410	450
	8 GB	1880	2850	520	580	730	2210	3720	540	610
	12 GB	2840	4300	790	870	1100	3330	5610	820	920
	16 GB	3800	5740	1060	1170	1470	4450	7480	1100	1230
	24 GB	5510	8340	1540	1700	2130	6460	10870	1600	1780
	32 GB	7620	11520	2130	2350	2940	8930	15010	2220	2470
48 GB	11030	16550	3110	3430	4330	13000	21420	3250	3600	
64 GB	14970	22460	4220	4660	5880	17650	29070	4410	4890	

Aspect ratio		16:9								
Resolution		4.5 M (37)				2.5 M (37)				
Quality				RAW 	RAW 				RAW 	RAW 
Internal Memory (Approx. 40 MB)		14	26	2	2	18	35	2	3	
Card	512 MB	155	290	34	38	195	380	36	39	
	1 GB	310	580	69	77	390	770	72	80	
	2 GB	640	1180	140	155	800	1570	145	160	
	4 GB	1260	2320	270	310	1580	3090	290	320	
	6 GB	1930	3520	420	470	2410	4700	440	480	
	8 GB	2580	4720	570	630	3230	6290	590	650	
	12 GB	3890	7120	860	950	4870	9490	900	980	
	16 GB	5200	9500	1140	1270	6500	12670	1200	1320	
	24 GB	7550	13790	1660	1850	9440	18390	1740	1910	
	32 GB	10430	19060	2300	2560	13040	25410	2410	2640	
48 GB	15170	28020	3370	3750	19170	36420	3530	3870		
64 GB	20590	38020	4570	5090	26010	49430	4790	5250		

Aspect ratio		16:9							
Resolution		2 M (74)				0.2 M (74)			
Quality				RAW 	RAW 			RAW 	RAW 
Internal Memory (Approx. 40 MB)		42	83	3	3	310	470	3	3
Card	512 MB	450	880	40	42	3350	5030	43	43
	1 GB	910	1770	81	85	6710	10070	88	88
	2 GB	1860	3610	165	170	12290	20480	180	180
	4 GB	3650	7090	320	340	24130	40220	350	350
	6 GB	5560	10790	490	520	36700	61160	530	540
	8 GB	7440	14440	660	690	49120	81870	720	720
	12 GB	11220	21790	1000	1050	74090	123490	1080	1090
	16 GB	14970	29060	1340	1400	98830	164730	1450	1460
	24 GB	21740	42200	1940	2030	143510	239180	2100	2120
	32 GB	30040	58310	2690	2810	198260	330440	2910	2930
	48 GB	40470	72850	3950	4130	261130	424270	4280	4280
64 GB	54920	98860	5370	5610	347150	564310	5810	5810	

## ■ Available recording time (when recording motion pictures)

File format		[AVCHD Lite]			[MOTION JPEG]				
Picture quality setting									
Internal Memory (Approx. 40 MB)		Cannot be used.							1 min 26 s
Card	512 MB	3 min 00 s	4 min 00 s	7 min 00 s	2 min 00 s	5 min 10 s	5 min 20 s	15 min 40 s	
	1 GB	7 min 00 s	9 min 00 s	13 min 00 s	4 min 00 s	10 min 20 s	10 min 50 s	31 min 20 s	
	2 GB	15 min 00 s	20 min 00 s	29 min 00 s	8 min 20 s	21 min 20 s	22 min 10 s	1 h 3 min	
	4 GB	30 min 00 s	40 min 00 s	57 min 00 s	16 min 30 s	41 min 50 s	43 min 40 s	2 h 5 min	
	6 GB	46 min 00 s	1 h 1 min	1 h 28 min	25 min 10 s	1 h 3 min	1 h 6 min	3 h 11 min	
	8 GB	1 h 2 min	1 h 22 min	1 h 58 min	33 min 40 s	1 h 25 min	1 h 28 min	4 h 15 min	
	12 GB	1 h 34 min	2 h 4 min	2 h 59 min	50 min 50 s	2 h 8 min	2 h 14 min	6 h 26 min	
	16 GB	2 h 6 min	2 h 45 min	3 h 59 min	1 h 8 min	2 h 52 min	2 h 59 min	8 h 35 min	
	24 GB	3 h 4 min	4 h 00 min	5 h 47 min	1 h 38 min	4 h 9 min	4 h 19 min	12 h 27 min	
	32 GB	4 h 14 min	5 h 32 min	8 h 00 min	2 h 16 min	5 h 45 min	5 h 59 min	17 h 13 min	
	48 GB	6 h 13 min	8 h 8 min	11 h 45 min	3 h 20 min	8 h 27 min	8 h 47 min	25 h 18 min	
	64 GB	8 h 27 min	11 h 3 min	15 h 58 min	4 h 32 min	11 h 28 min	11 h 56 min	34 h 21 min	

### • With camera models 18 151 / 18 152:

Motion pictures can be recorded continuously in [MOTION JPEG] up to a capacity of 2 GB.

Only the maximum recordable time for 2 GB is displayed on the screen.

Maximum time to record motion pictures continuously with [AVCHD Lite] is 13 hours 3 minutes 20 seconds. Screen will only display up to 13 hours 3 minutes 20 seconds. However, the recording may stop before that depending on the remaining battery level. (P19)

### • With camera model 18 150:

Motion pictures can be recorded continuously for up to 29 minutes. Also, motion pictures can be recorded continuously in [MOTION JPEG] up to a capacity of 2 GB. (Example: [8m 20s] with ) Remaining time for continuous recording is displayed on the screen.

### Note

- The number of recordable pictures and the available recording time displayed on the screen may not decrease in order.
- The Extended Optical Zoom does not work when in [HIGH SENS.], [HI-SPEED BURST] and [FLASH BURST] in Scene Mode so resolution for  is not displayed.

## Leica Service Addresses

### **Leica Academy**

As well as outstanding high-performance products for taking and viewing photographs, for many years we have also been offering the special services of the Leica Akademie, with practical seminars and training courses, which are intended to share our knowledge about the world of photography, projection and magnification with both beginners and advanced photographic enthusiasts.

The contents of the courses, which are run by a trained team of experts in the modern, well-equipped training suite at our Solms factory and in the nearby Gut Altenberg, vary from general photography to areas of special interest and offer a range of suggestions, information and advice for your own work.

More detailed information and the current Leica Akademie brochure are available from:

Leica Camera AG  
Leica Akademie  
Oskar-Barnack-Str. 11  
D-35606 Solms  
Phone: +49 (0) 6442-208-421  
Fax: +49 (0) 6442-208-425  
la@leica-camera.com

### **Leica on the Internet**

Current information about products, news, events and the Leica company is available on our homepage on the Internet at:

<http://www.leica-camera.us>  
<http://www.leica-camera.co.uk>

### **Leica information service**

The Leica information service can provide you with an answer to any technical questions relating to the Leica range either in writing, on the telephone or by e-mail.

Leica Camera AG  
Informations-Service  
Postfach 1180  
D-35599 Solms  
Phone: +49 (0) 6442-208-111  
Fax: +49 (0) 6442-208-339  
info@leica-camera.com

### **Leica Customer Service**

Leica AG's Customer Service center, or the repair service of the Leica national offices (see the Warranty Card for an address list), is available to assist you in maintaining your Leica equipment or in case of damage.

Please contact your nearest authorised Leica dealer.

Leica Camera AG  
Customer Service  
Solmsler Gewerbepark 8  
D-35606 Solms  
Phone: +49 (0) 6442-208-189  
Fax: +49 (0) 6442-208-339  
customer.service@leica-camera.com

- SDXC Logo is a trademark of SD-3C, LLC.
- The “AVCHD”, “AVCHD Lite” and the “AVCHD”, “AVCHD Lite” logo are trademarks of Panasonic Corporation and Sony Corporation.
- Manufactured under license from Dolby Laboratories.  
Dolby and the double-D symbol are trademarks of Dolby Laboratories.
- HDMI, the HDMI Logo, and High-Definition Multimedia Interface are trademarks or registered trademarks of HDMI Licensing LLC in the United States and other countries.
- QuickTime and the QuickTime logo are trademarks or registered trademarks of Apple Inc., used under license therefrom.
- Microsoft product screen shot(s) reprinted with permission from Microsoft Corporation.
- Leica is a registered trademark of Leica Microsystems IR GmbH.
- Summicron is a registered trademark of Leica Camera AG.
- Other names, company names, and product names printed in these instructions are trademarks or registered trademarks of the companies concerned.



**AVCHD** Lite™



**HDMI**



This product is licensed under the AVC patent portfolio license for the personal and non-commercial use of a consumer to (i) encode video in compliance with the AVC Standard (“AVC Video”) and/or (ii) decode AVC Video that was encoded by a consumer engaged in a personal and non-commercial activity and/or was obtained from a video provider licensed to provide AVC Video. No license is granted or shall be implied for any other use. Additional information may be obtained from MPEG LA, LLC. See <http://www.mpegla.com>.



Leica Camera AG / Oskar-Barnack-Straße 11 / 35606 SOLMS / GERMANY  
Telephone +49(0)6442-208-0 / Telefax +49(0)6442-208-333  
[www.leica-camera.com](http://www.leica-camera.com)