



LEICA M
Instructions

FOREWORD

Dear Customer,

Leica would like to thank you for purchasing the Leica M and congratulate you on your choice. With this unique digital view and rangefinder camera, you have made an excellent choice.

We wish you a great deal of pleasure and success using your new Leica M.

In order to make best use of all the opportunities offered by this high performance camera, we recommend that you first read these instructions.

Notes:

- Leica is constantly working on developing and optimizing the Leica M. As many functions on digital cameras are controlled by software, improvements and extensions to the range of functions may need to be installed on the camera at a later date. To do this, Leica releases what are known as firmware updates at irregular intervals. The cameras always have the latest firmware version when shipped, and you can also download it easily from our home page and install it on your camera.
If you register as an owner on the Leica Camera home page, you will receive a newsletter informing you when a new firmware update is available.
Further information on registration and firmware updates for your Leica M, as well as any amendments and additions to the details provided in the manual, can be found in the "Owners' Login" area at: <https://owners.leica-camera.com>
You can tell whether your camera is running the latest firmware version by selecting **Firmware** in the main menu (page 5, **SETUP**, see p. 154, 246).
- Before using your Leica M for the first time, please check that the accessories supplied are complete.

This is a Class B product based on the standard of the Voluntary Control Council for Interference from Information Technology Equipment (VCCI). If this is used near a radio or television receiver in a domestic environment, it may cause radio interference. Install and use the equipment according to the instruction manual.

FCC Note: (U. S. only)

This equipment has been tested and found to comply with the limits for a Class B digital device, pursuant to Part 15 of the FCC Rules. These limits are designed to provide reasonable protection against harmful interference in a residential installation. This equipment generates, uses, and can radiate radio frequency energy and, if not installed and used in accordance with the instructions, may cause harmful interference to radio communications. However, there is no guarantee that interference will not occur in a particular installation. If this equipment does cause harmful interference to radio or television reception, which can be determined by turning the equipment off and on, the user is encouraged to try to correct the interference by one or more of the following measures:

- Reorient or relocate the receiving antenna.
- Increase the separation between the equipment and receiver.
- Connect the equipment into an outlet on a circuit different from that to which the receiver is connected.
- Consult the dealer or an experienced radio/TV technician for help.

FCC Caution:

To assure continued compliance, follow the attached installation instructions and use only shielded interface cables with ferrite core when connecting to computer or peripheral devices. Any changes or modifications not expressly approved by the party responsible for compliance could void the user's authority to operate this equipment.

Trade Name: LEICA
Model No.: LEICA M (Typ 240)
Responsible party/
Support contact: Leica Camera Inc.
1 Pearl Count, Unit A
Allendale, New Jersey 07401
Tel.: +1 201 995 0051
Fax: +1 201 995 1684
technicalinfo@leicacamerausa.com

This device complies with Part 15 of the FCC Rules. Operation is subject to the following two conditions: (1) This device may not cause harmful interference, and (2) this device must accept any interference received, including interference that may cause undesired operation.

This Class B digital apparatus complies with Canadian ICES-003

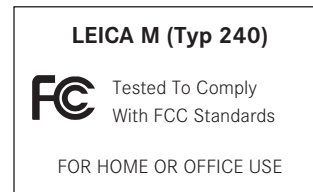

CONTENTS

Foreword	130
Warning messages	134
Legal information	134
Disposal of electrical and electronic equipment	135
Designation of parts	136
Quick guide.....	138
Detailed guide	
Preparations	
Attaching the carrying strap.....	140
Charging the battery.....	141
Replacing the battery and memory card.....	144
Leica M lenses	147
Attaching the lens	149
Detaching the lens	149
The most important settings / controls	150
Turning the camera on and off	150
The shutter button	151
Serial exposures	152
Shutter speed dial	153
Menu control.....	154

Presets

Basic camera settings	
Menu language.....	158
Date and time.....	158
Automatic power off	160
Signal tones	161
Basic picture settings	
Turning lens type identification on and off.....	162
Compression rate/file format	163
Resolution	163
White balance.....	165
ISO sensitivity.....	167
Picture properties / Contrast, sharpness, color saturation	169
Film styles	170
Working color space	170
Bright line view and range finder	171
The monitor.....	173
Live view mode	174

Range measurement.....	175	Additional functions.....	216
With the optical range finder	175	Folder management.....	216
With the monitor in live view mode	177	Formatting the memory card.....	218
Focus peaking	178	Transferring data to a computer.....	219
Turning the exposure meter on/off.....	179	Adobe® Photoshop® Lightroom®	222
Exposure metering methods	180	Leica Image Shuttle®	222
Exposure modes.....	182	Working with DNG raw data	222
Aperture priority	182	Installing firmware updates	223
Exposure lock	183	Miscellaneous	224
Exposure compensation	184	Leica M system accessories.....	224
Automatic bracketing.....	186	Spare parts	227
Manual exposure setting.....	188	Safety and care instructions.....	228
The B setting / The T function	188	General precautionary measures	228
Values above and below the metering range	189	Care instructions.....	230
Flash mode	190	Cleaning the sensor / dust detection	234
Additional functions.....	196	Storage	236
Video clips	196	Malfunctions and their resolution	236
Sound recording.....	197	Appendix	238
Taking photographs with the self-timer.....	198	Displays	238
Marking image files for copyright protection	198	Menu options.....	246
Recording the shooting location using GPS	198	Index	248
Virtual horizon	201	Technical data	250
User / application specific profiles	201	Leica addresses	254
Resetting all custom settings	203		
Review mode.....	204		

The CE identification of our products documents compliance with the fundamental requirements of the valid EU directives.

WARNING MESSAGES

- Modern electronic elements react sensitively to electrostatic discharge. As people can easily pick up charges of tens of thousands of volts, by walking on synthetic carpets for example, a discharge can occur when you touch your Leica M, particularly if it is placed on a conductive surface. If only the camera housing is affected, this discharge is harmless to the electronics. However, despite built-in safety circuits, the outer contacts, such as the battery or rear panel contacts, should not be touched if at all possible for safety reasons.
- For any cleaning of the contacts, do not use an optical micro-fiber cloth (synthetic); use a cotton or linen cloth instead. Before touching the contacts, you can make sure you discharge any electrostatic charge by deliberately touching a heating or water pipe (conductive, earthed material). You can also avoid soiling and oxidization of the contacts by storing your Leica M in a dry place with the lens or bayonet cover fitted.
- You should use only the recommended accessories to prevent faults, short circuits or electric shock.
- Do not attempt to remove parts of the body (covers); specialist repairs can be carried out only at authorized service centers.

LEGAL INFORMATION

- Please ensure that you observe copyright laws. The recording and publication of pre-recorded media such as tapes, CDs, or other published or broadcast material may contravene copyright laws.
- This also applies to all of the software supplied.
- The SD, HDMI, and USB logos are registered trademarks.
- Other names, company or product names referred to in these instructions are trademarks or registered trademarks of the relevant companies.



DISPOSAL OF ELECTRICAL AND ELECTRONIC EQUIPMENT

 (Applies within the EU, and for other European countries with segregated waste collection systems)

This device contains electrical and/or electronic components and should therefore not be disposed of in general household waste. Instead it should be disposed of at a recycling collection point provided by the local authority. This costs you nothing. If the device itself contains replaceable (rechargeable) batteries, these must be removed first and, if necessary, also be disposed of in line with the relevant regulations.

Your local authority or waste disposal authority, or the shop where you bought this device, can provide you with further information on this issue.



DESIGNATION OF PARTS

Figures in the front and rear cover pages

Front view

1. Lens release button
2. Eyes for carrying strap
3. Focusing button
4. Range finder viewing window
5. Brightness sensor¹
6. Viewfinder viewing window
7. Self-timer LED
8. Bottom cover locking point

Top view

9. Microphone
10. Fixed ring with
 - a. Index for range setting
 - b. Depth of field scale and
 - c. Red index button for changing lenses
11. Aperture setting ring
12. White index point for aperture setting
13. Lens hood
14. Focusing ring with
 - a. Recessed grip
15. Main switch with detent positions for
 - **OFF** (camera turned off)
 - **S** (single pictures)
 - **C** (continuous pictures)
 -  (self-timer)
16. Shutter release with
 - a. Thread for cable release
17. Video shutter release
18. Time setting dial with detent positions for
 - **A** for automatic shutter speed control
 - Shutter speeds $1/4000$ - 8s (inc. intermediate values)
 - **B** (long-time exposure)
 -  Flash sync speed ($1/180$ S)
19. Flash unit shoe

¹ Leica M lenses with viewfinder attachment cover the brightness sensor. Information about functions with these and other lenses can be found in the "Displays / In the viewfinder", p. 238, and "Leica M lenses, p. 147 sections.

Rear view

20. **SET** button
 - For calling up the picture parameters menu
 - For calling up sub-menus the menu system
 - For applying settings/functions selected in sub-menus
21. **MENU** button for calling up and exiting the main menu and sub-menus
22. **ISO** button for calling up the sensitivity setting
23. **DELETE** button for selecting the delete function
24. **PLAY** button
 - For activating (continuous) review mode
 - To return to full-screen display
25. **LV** button for turning live view mode on and off
26. Viewfinder window
27. Socket for external electronic viewfinder / microphone adapter¹
(cover removed)
28. Brightness sensor for monitor
29. Setting dial
 - For navigating in the menus
 - For setting the selected menu options / functions
 - For setting an exposure compensation value
 - For enlarging/reducing pictures viewed
 - For scrolling through the picture memory
30. Direction pad
 - For navigating in the menus
 - For setting the selected menu options / functions
 - For scrolling through the picture memory

31. **INFO** button
 - For displaying picture settings/data
 - For displaying picture data during picture review
 - For applying settings
32. Speaker
33. LED for indicating picture mode / recording data
34. Monitor

Bottom view

(with bottom cover fitted)

35. Locking toggle for bottom cover
36. Tripod thread A ¼, DIN 4503 (¼")
37. Bottom cover

(with bottom cover removed)

38. Socket for multifunction M hand grip ¹
39. Memory card slot
40. Battery compartment
41. Battery locking slider

¹ Available as accessory, see p. 226

QUICK GUIDE

YOU WILL NEED THE FOLLOWING ITEMS:

- Camera
- Battery
- Memory card (not supplied)
- Charger and mains cable

PREPARATIONS

1. Charge the battery (see p. 141)
2. Insert the battery (see p. 144)
3. Insert the memory card (see p. 146)
4. Turn on the camera (see p. 150)
5. Set the menu language (see p. 158)
6. Set the date and time (see p. 158)
7. Format the memory card, if necessary (see p. 218)

TAKING PHOTOGRAPHS

8. Attach the lens (see p. 149)
9. Set the shutter speed dial to A (see p. 153)
10. Set the subject focus (see p. 174)
11. Turn on the camera (see p. 150)
12. Turn on exposure metering (see p. 151)
13. Correct the exposure, if necessary (see p. 182)
14. Release the shutter (see p. 151)

Note:

For details of how to shoot videos, see p. 196

VIEWING PICTURES

The camera is preset to display the last picture automatically for a short time (see p. 204).

You can turn on review mode (for an unlimited period) at any time using the **PLAY** button (see p. 204).

To view different pictures, press left or right on the direction pad (see p. 210).

To enlarge the picture turn the setting dial to the right (see p. 211).

DELETING PICTURES

Press the **DELETE** button and follow the instructions in the monitor (see p. 212).

DETAILED GUIDE

PREPARATIONS

ATTACHING THE CARRYING STRAP

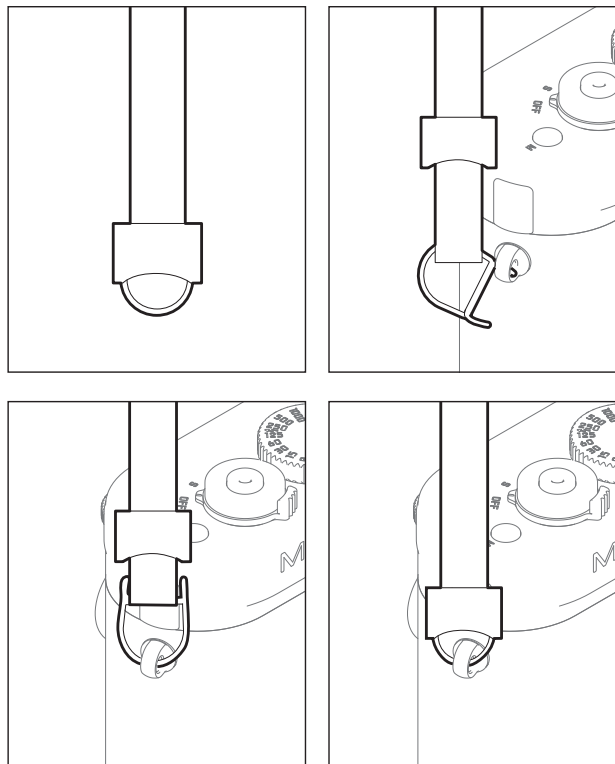

CHARGING THE BATTERY

The Leica M is powered by a lithium ion battery.

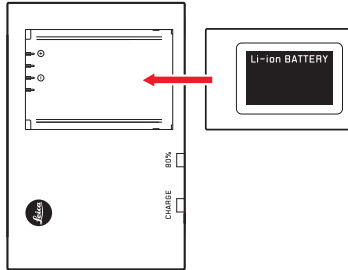

- The green LED marked **CHARGE** starts flashing to confirm that charging is in progress. As soon as the battery has charged to at least $\frac{4}{5}$ of its capacity, the yellow LED marked **80%** also lights up. When the battery is fully charged, the green LED also changes from flashing to continuously lit.

Note:

The **80%** LED lights up after around 2 hours due to the charging characteristics.

The charger should then be disconnected from the mains. There is therefore no risk of overcharging.

¹ (in live view / **Classic** mode)

Attention:

- Only the battery type specified and described in these instructions (order no. 14 499), or battery types specified and described by Leica Camera AG, may be used in this camera.
 - These batteries may only be used in the units for which they are designed and may only be charged exactly as described below.
 - Using this battery contrary to the instructions and using non-specified battery types can result in an explosion under certain circumstances.
 - The batteries may not be exposed to heat, sunlight, humidity or moisture for long periods. Likewise, the batteries may not be placed in a microwave oven or a high pressure container as this results in a risk of fire or explosion.
 - A safety valve in the battery guarantees that any excess pressure caused by improper handling is discharged safely.
 - Only the charger specified and described in these instructions (order no. 14 494) is to be used. The use of other chargers not approved by Leica Camera AG can cause damage to the batteries and, in extreme cases, can cause serious or life-threatening injuries.
- The charger supplied should be used exclusively for charging this battery type. Do not attempt to use it for other purposes.
 - The car charging cable supplied may never be connected while the charger is connected to the mains.
 - Ensure that the mains outlet used for charging is freely accessible.
 - The battery and charger may not be opened. Repairs may only be carried out by authorized workshops.

Notes:

- The battery should be charged before the Leica M is used for the first time.
- The battery must have a temperature of 10°-30°C /50°-86°F to be charged (otherwise the charger will not turn on, or will turn off again).
- Lithium ion batteries can be charged at any time, regardless of their current charge level. If a battery is only partly discharged when charging starts, it is charged to full capacity faster.
- The batteries warm up during the charging process. This is normal and not a malfunction.
- If the two LEDs on the charger flash rapidly (> 2Hz) after starting charging, this indicates a charging error (e.g. maximum charging time exceeded, voltages or temperatures outside the permitted ranges, or short circuit). In this case, disconnect the charger from the mains and remove the battery. Ensure that the above temperature conditions are met and then restart the charging process. If the problem persists, please contact your dealer, the Leica office in your country or Leica Camera AG.
- A new battery only reaches its full capacity after it has been fully charged and – by use in the camera – discharged again 2 or 3 times. This discharge procedure should be repeated every 25 cycles. To maximize the life of the battery, it should not be exposed to extremely high or low temperatures (e. g. in a stationary vehicle in summer or winter) for long periods.
- Even when used in optimum conditions, every battery has a limited service life. After several hundred charging cycles, this becomes noticeable as the operating times get significantly shorter.
- The battery should be replaced after a maximum of four years, as its performance deteriorates and reliable operation can no longer be guaranteed, particularly in cold conditions.
- Defective batteries should be disposed of in line with the applicable regulations (see p. 199).
- The replaceable battery provides power to a back-up battery which is permanently fitted in the camera. This back-up battery retains the set date and time for up to 2 months. If this back-up battery becomes discharged it must be recharged by inserting the replaceable main battery. Once the replaceable battery has been inserted, the full capacity of the back-up battery is recovered after about a few days. This process does not require the camera to be turned on.

REPLACING THE BATTERY AND MEMORY CARD

Set the main switch (1.18) to OFF.

Important:

Do not open the bottom cover or remove the memory card or battery whilst the red LED (33) at the bottom right of the monitor (34) is flashing, indicating picture recording and/or data saving to the card. Otherwise the unsaved (or not completely saved) picture data may be lost.

Removing the bottom cover

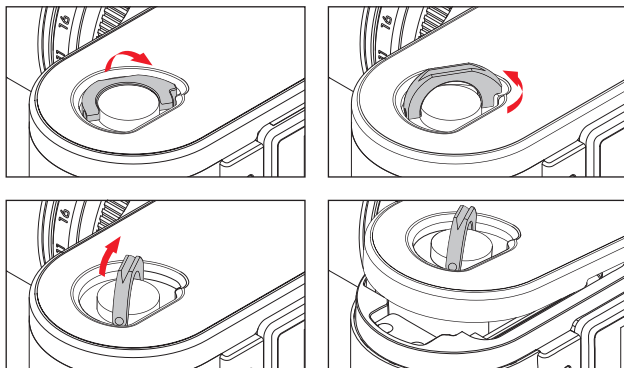

Inserting the battery

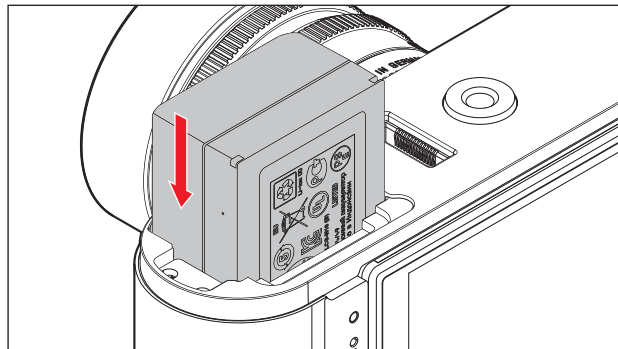

Removing the battery

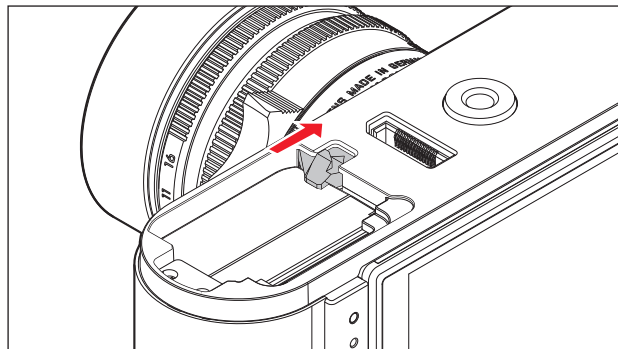

Charge level displays

In picture mode, the battery charge level is displayed in the monitor (34) by pressing the **INFO** button (31).

Notes:

- Remove the battery if you will not be using the camera for a long period of time.
- A maximum of 2 months after the capacity of a battery left in the camera is exhausted (see also the last note under “Charging the battery”, p. 141), the date and time need to be re-entered.
- As the battery capacity deteriorates or if using an older battery, depending on the function being used warning messages and displays may appear and functions may be restricted or blocked.

Compatible memory cards

The Leica M saves the pictures on an SD (secure digital), SDHC (high capacity), or SDXC (eXtended capacity) card. SD/SDHC/SDXC memory cards are available from various suppliers and with different capacities and read/write speeds. Particularly those with high capacities and read/write speeds allow data to be recorded and retrieved very quickly. The cards have a write protection switch, which can be used to prevent unintentional storage and deletion of pictures. This switch takes the form of a slider on the non-beveled side of the card; in the lower position, marked LOCK, the data on the card is protected.

Note:

Do not touch the memory card contacts.

Inserting the memory card

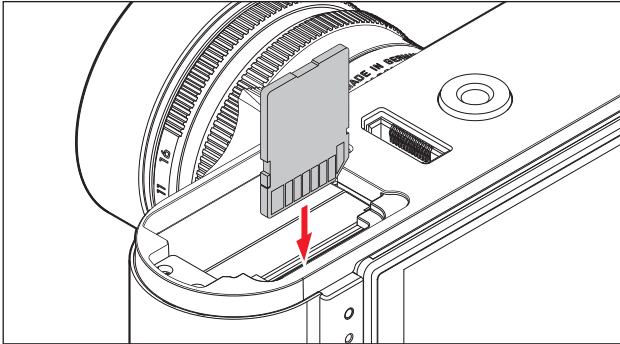

Removing the memory card

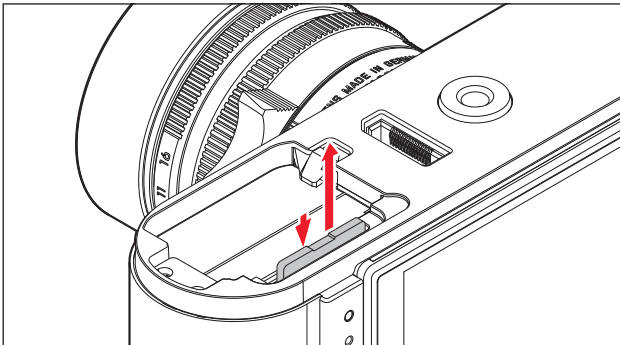

Notes:

- The range of SD/SDHC/SDXC cards is too large for Leica Camera AG to be able to completely test all available types for compatibility and quality. Although using other card types is not likely to damage the camera or the card, some "no name" cards do not comply with the SD/SDHC/SDXC standards, and Leica Camera AG is unable to provide any guarantee that they will function correctly.
- Video recordings in particular require a high write speed.
- If the memory card cannot be inserted, check that it is aligned correctly.
- If you remove the bottom cover or take out the memory card when the camera is turned on, the monitor displays the corresponding warning messages instead of the normal displays:
 - **Attention Bottom cover removed**
 - **Attention No card inserted.**
- As electromagnetic fields, electrostatic charge, and defects on the camera or the card can lead to damage or loss of the data on the memory card, we recommend that you also transfer the data to a computer and save it there (see p. 220).
- For the same reason, it is recommended that the card is always stored in its antistatic cover.

LEICA M LENSES

Generally speaking, most Leica M lenses can be used on the Leica M. Details on the small number of exceptions and restrictions can be found in the following notes.

They can be used regardless of the lens features, and whether it does or does not have 6-bit coding in the bayonet.

Even without this additional feature, i.e. when using Leica M lenses without identification, the Leica M will deliver excellent pictures in most situations.

To ensure optimum picture quality in these situations, we recommend entering the lens type (see p. 162).

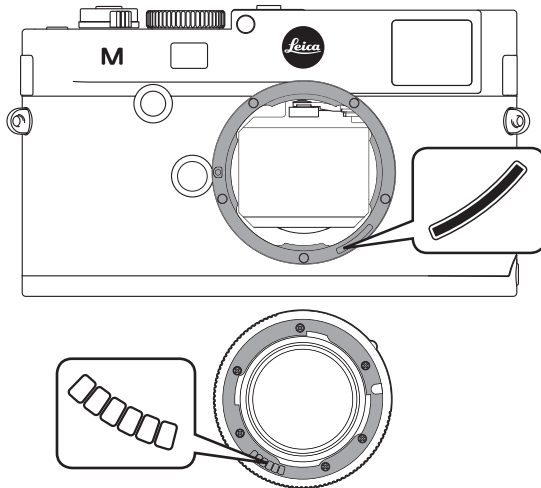

Important:

- Cannot be used:
 - Hologon 15mm f/8
 - Summicron 50mm f/2 with close up attachment.
 - Elmar 90mm f/4 with retractable tube (manufactured from 1954-1968)
 - Some versions of the Summilux-M 35mm f/4 (not aspherical, manufactured from 1961-1995, Made in Canada) cannot be fitted to the Leica M or will not focus to infinity. The Leica Customer Care department can modify these lenses so that they can be used on the Leica M.
- Can be used but with a risk of damaging the camera or lens: Lenses with retractable tube can only be used with the tube extended, i.e. their tube must never be retracted into the Leica M. This is not the case with the current Macro-Elmar-M 90mm f/4, as its tube does not protrude into the camera body even when retracted. It can therefore be used without any restrictions.

- Can be used with restrictions
Despite the high precision of the rangefinder on the Leica M, exact focusing with 135mm lenses with an open aperture cannot be guaranteed due to the very low depth of field. Therefore, stopping down by at least 2 stops is recommended.
By contrast, live view mode (see p. 173) on the Leica M and the various setting facilities allow unrestricted use of this lens.
- Can be used but are excluded from **Classic** exposure metering (see p. 180)
 - Super-Angulon-M 21mm f/4
 - Super-Angulon-M 21mm f/3.4
 - Elmarit-M 28mm f/2.8 with serial nos. before 2 314 921.

Notes:

- The Leica Customer Care department can upgrade many Leica M lenses with 6-bit coding (for address, see p. 254).
- In addition to Leica M lenses with and without coding using the Leica M adapter available as an accessory (see p. 224), Leica R lenses can also be used on the Leica M.

Attaching the lens

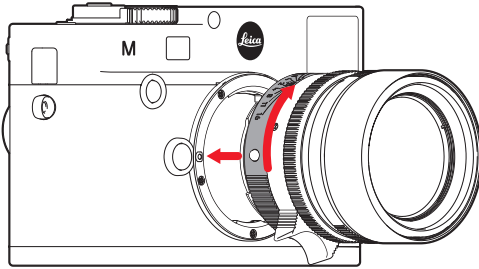

1. Turn off the camera
2. Hold the lens by the fixed ring (10).
3. Align the red index button (10b) on the lens with the release button (1) on the camera housing
4. In this position, insert the lens.
5. Turn the lens slightly to the right, and you will hear and feel it click into place.

Detaching the lens

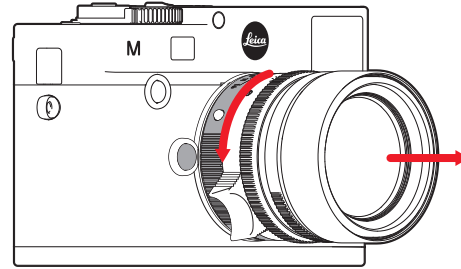

1. Turn off the camera
2. Hold the lens by the fixed ring (10).
3. Press down the shutter button (1) on the camera body.
4. Turn the lens to the left until its red index button (10b) is aligned with the shutter button.
5. Remove the lens.

Notes:

- Generally: To protect the Leica M against ingress of dust etc. into the interior of the camera, it is important always to have a lens or a cover fitted to the camera body.
- For the same reason, when changing lenses work quickly and in an environment that is as dust-free as possible.
- Camera or lens rear covers should not be stored in your pants pocket as they attract dust that can get into the camera when they are attached.

THE MOST IMPORTANT SETTINGS / CONTROLS

TURNING THE CAMERA ON AND OFF

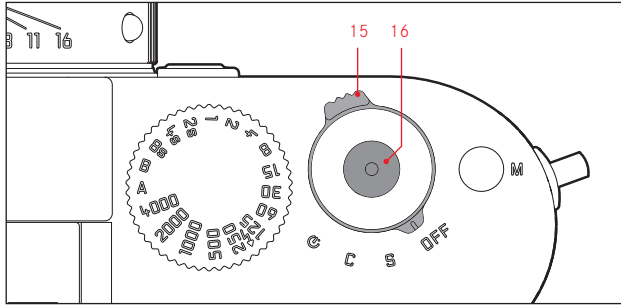

The Leica M is turned on and off using the main switch (15). This is below the shutter button (16) and is a lever with four detent positions:

- a. **OFF** - Camera turned off
- b. **S** - Single picture
Pressing the shutter button takes a single picture regardless of how long it is held down for.

- c. **C** - Continuous series
A series of pictures are taken for as long as the shutter release is held down and the capacity of the memory card used and the internal buffer memory is sufficient (see "Replacing the memory card", p. 144). The first 8 pictures are taken in rapid succession, subsequent pictures with a reduced frequency.
- d. **☺** - Self-timer
Pressing the shutter release starts the set delay time (see p. 198), then the picture is taken.

TURNING ON

After turning on, i.e. after setting one of the three functions **S**, **C** or **☺**, the LED (33) lights up briefly and the displays in the viewfinder appear (see p. 238).

Note:

After turning on, the camera is ready to use after approx. 1s.

TURNING OFF

Even if the main switch is not set to **OFF** the camera is automatically turned off if an automatic power off time has been set in the menu (**Auto Power Off**, see p. 160), and none of the controls are used in this time.

Note:

If the camera is out of use for an extended period or is stored in a case, always turn it off at the main switch. This prevents any power consumption, including that which continues to occur in standby mode after the exposure meter is turned off automatically and the display is extinguished. This also prevents pictures from being taken accidentally.

THE SHUTTER BUTTON

The shutter button (16) has two pressure points:

1. Pressing down to the 1st pressure point
 - activates exposure metering and the viewfinder display
 - saves the metered exposure value in aperture priority mode, i.e. the shutter speed determined by the camera (for more details, refer to the “Metering memory lock” section on p. 183).
 - restarts a self-timer delay time that is already in progress (see p. 198)

If the shutter button is kept at this pressure point, the displays remain visible, or if the camera had previously been set to review mode, it switches back into picture mode. If the camera was previously in standby mode (see p. 150), it is reactivated and the display is turned on.

If you let go of the shutter release button, the metering system and the displays remain activated for around a further 12s (for more details, refer to the sections under “Exposure metering” on p. 180).

Note:

The shutter release button remains blocked

- if the internal buffer memory is (temporarily) full, e.g. after a series of ≥ 8 pictures, or
 - if the memory card inserted and the internal buffer memory are (temporarily) full, or
 - if the battery has exceeded its performance limits (capacity, temperature, age)
2. Pressing the shutter button all the way down takes the picture or starts a preselected self-timer delay time. The data is then transferred to the memory card.

The shutter button has a standard thread (16) for a cable release.

Notes:

- If review mode (see "Review mode", p. 204) or menu control (see p. 154) was previously active, tapping the shutter button immediately switches to picture mode.
- To avoid blurring, the shutter button should be pressed gently – not jerkily, until the shutter is released with a soft click.
- The shutter release button can be pressed to take one or more individual pictures while a video recording is in progress. Details of video recordings and the video shutter release (17) can be found on p.196.

Serial exposures

On the Leica M, you can not only take single pictures - by setting the main switch (15) to **[S]** [single] – but also series of pictures, by setting the main switch to **[C]** [continuous]), e.g. to capture sequences of movement in several stages.

Apart from operation of the shutter button (16), series of pictures are taken in the same way as single pictures: A series of pictures is taken for as long as you hold down the shutter release (provided that the memory card has sufficient capacity). If you only press it briefly, the camera continues to take single pictures.

A maximum of around 3 frames per second can be produced. At least the first 8 of these are taken in rapid succession, after which the image frequency is reduced slightly.

Notes:

- The specified picture frequency and the maximum possible number of pictures in a series relate to a standard setting – **ISO 200** and **JPEG fine** format. The frequency and number may be lower when using different settings or depending on the memory card used.
- Regardless of how many pictures are taken in a series, in both review modes (see p. 204) the last picture in the series or the last picture in the series stored on the card - if not all pictures in the series have been transferred from the camera's buffer memory to the card at this point - is displayed first.

SHUTTER SPEED DIAL

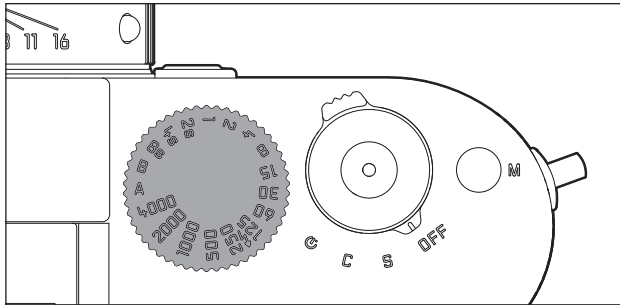

The exposure modes are selected using the shutter speed dial (18) on the Leica M,

- Aperture priority mode by selecting the **A** position marked in red (see p. 182),
- Manual mode by selecting a shutter speed of $1/4000$ s to 8s, (intermediate values in $1/2$ step positions are also available), and
- the shortest possible sync speed for flash mode - marked with the ⚡ symbol - of $1/180$ s (see p. 191), and
- **B** for long exposures (see p. 188).

The Leica M shutter speed dial has no stop, i.e. it can be turned in either direction from any position. It detents at all marked positions and at the intermediate values. Values between the detent positions cannot be used. More details on setting the correct exposure can be found in the sections under „Exposure metering” starting on p. 179.

MENU CONTROL

Many settings on the Leica M are controlled using two separate menus (see p. 246/247).

MAIN MENU

The main menu is made up of 34 options. It is divided into 3 function groups:

- **CAMERA** (basic camera settings - page 1)
- **IMAGE** (picture settings - page 2)
- **SETUP** (supplementary functions - pages 3-5)

PICTURE PARAMETERS MENU

The picture parameters menu is made up of 8 options. In addition to basic picture settings, it contains two options relating to exposure metering and control and one that can be used to create and call up user profiles.

The split into two menus and the grouping in the main menu allows what experience has shown to be the most frequently used options to be called up and set quickly and easily.

When the camera is turned on, an overview of the relevant settings and step-by-step instructions for setting these options can be viewed in the monitor (34).

Settings are made in the same way in both menus, the differences are only in calling up and exiting them.

Setting the menu functions

1. The main menu is called up using the **MENU** button (21) and the picture parameters menu using the **SET** button (20).
 - The first = **CAMERA** - page containing the first six options then appears in the main menu, and all options in the picture parameters menu.
The active option when a page is selected is always the last one to be changed.

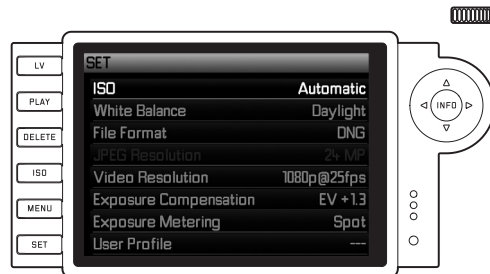
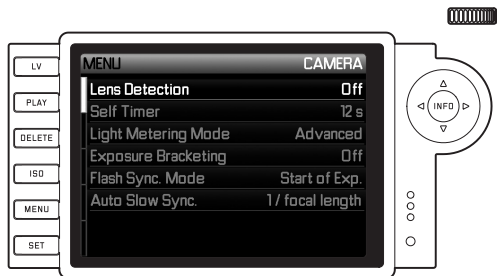

Note:

The picture parameters menu is only accessible when the camera is in picture mode.

2. You can select the relevant option either using the setting dial (29; turn right = down in menu, turn left = up in menu) or the direction pad (30; press up or down).

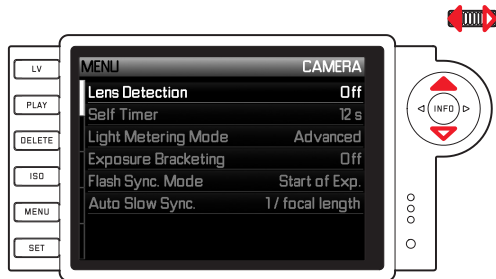
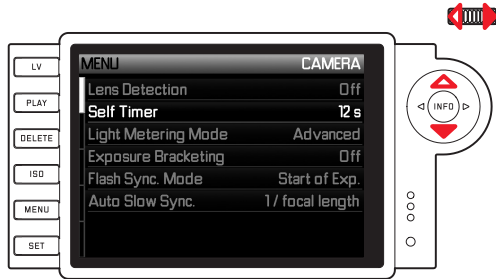

Notes:

- Using the setting dial is normally not only more convenient but also significantly faster.
 - Some options, such as **GPS** and **Format SD card**, as well as some sub-menu options, can only be called up in certain situations. Further explanations can be found in the relevant sections.
 - This is indicated by the lettering in the corresponding lines being grayed out.
3. You can select the relevant sub-menus with both the **SET** button and the **INFO** button (31) or by pressing right on the direction pad.
- The displays in the header change: The associated function group is shown in black on the left (**CAMERA**, **IMAGE** or **SETUP** in the main menu, always **SET** in the picture parameters menu), with the selected menu option in white on the right. The sub-menus usually consist of different numbers of function options, which can be directly selected in the next step. In some cases, there is also a scale for setting values, or the sub-menus consist of secondary entries for which function options can be selected in turn.

4. Select the relevant function option / value, either using the setting dial or by pressing the corresponding direction on the direction pad, i.e.
 - up/down to change lines or to select options
 - left/right for settings within a line or on a scale
 For sub-entries with selectable options, it is also possible to change line using the **INFO** button.
 - For sub-entries with selectable options, the displays in the header change again: The sub-entry is specified in black on the left, with the selected option in white on the right.

Note:

Options such as **Date/Time** and the **Exposure bracketing** and **White balance** functions require additional settings. The corresponding explanations, as well as further details about the other menu functions, can be found in the relevant sections.

5. Save your setting using the **SET** or **INFO** button.
 - The monitor screen reverts to its initial condition. The new function option set is then shown on the right of the corresponding menu line.

Note:

You can exit the menus and sub-menus at any time - without applying the settings made - by pressing the following buttons:

	Shutter button / PLAY		MENU
	Video shutter release	(24)	(21)
	(16/17)		
Main menu	Camera switches to picture mode	Camera switches to review mode	One step back (e.g. to previous menu level)
Picture parameters menu	Camera switches to picture mode	Camera switches to review mode	One step back (e.g. to previous menu level), or return to main menu

PRESETS

BASIC CAMERA SETTINGS

MENU LANGUAGE

The Leica M is set to English by default. German, French, Spanish, Italian, Russian, Japanese, and Traditional or Simplified Chinese can all be selected as alternative menu languages.

Setting the function

1. In the main menu (see p. 154/246) select **Language** (page 5, **SETUP** section), and
2. In the sub-menu the desired language

Apart from a few exceptions (button names, short designations), all linguistic information changes.

DATE AND TIME

These entries can be made by selecting **Date/Time** in the menu.

Setting the functions

1. In the main menu (see p. 154/246) select **Date/Time** (page 5, **SETUP** section), and
2. Call up the sub-menu. This is made up of the three options **Auto time/time zone**, **Date** and **Time**.

Automatic time display controlled by GPS

This option is only available if the multifunction M hand grip is attached (available as accessory, see p. 226).

3. Select **Auto time/Time zone**.
 - A further sub-menu appears, containing the options **Auto time via GPS**, (only available if the GPS function is activated in the menu, see p. 199), **Time zone** and **Summer time**.
4. In this sub-menu, select **Auto time via GPS**, and
5. Select the required option (**On/Off**).

If this function is activated, the time set on the camera is updated continuously based on GPS signals received.

For correct time display anywhere in the world:

6. In the same sub-menu select **Time zone**, and
7. Select the relevant zone / your current location.
 - The current set difference from Greenwich Mean Time is shown on the right of the line, with large cities and the current time in the relevant time zones below.

Entering the correct time in countries with seasonal time changes:

8. In the same sub-menu select **Summer time**, and
9. Set the preferred option (**On**/**Off**).

Note:

Time zone is only available when the **GPS** function is deactivated.

DATE

There are 3 options available for the sequence of the date.

3. In the **Date / Time** sub-menu, select **Date**. It contains the two options **Format** and **Setting**.
4. Select **Format**.
5. In the **Format** sub-menu, select which of the three possible sequences you want to use - **Day/Month/Year**, **Month/Day/Year**, or **Year/Month/Day**.
6. Save your setting.
 - The **Date** sub-menu appears again.
7. Select **Setting**.
 - A further sub-menu appears, with columns for the year and day figures and for the month names. The currently active, i.e. editable, column is indicated by red underlining, with the heading in white and the figures and names that can be set in red.
Use the setting dial (29) or the direction pad (30) to set the numbers / months and the **SET** button (20), the **INFO** button (31) or the direction pad to switch between the columns.
8. After making the setting, confirm all three headings and save them.

TIME

The time can either be shown in 24-hour or 12-hour format.

Both the display format and the actual figures are set using the **Time** option, essentially in exactly the same way as described for **Date** in the previous section.

Note:

Even if no battery is inserted or the battery is flat, an integrated back-up battery retains the date and time setting for around 2 months. After this time the date and time must be set again as described above.

AUTOMATIC POWER OFF

This function turns the Leica M off automatically after a preset time.

Setting the function

1. In the main menu (see p. 154/246) select **Auto Power Off** (page 5, **SETUP** section).
2. Now select the desired time.

Note:

Even if the camera is in standby mode, i.e. the displays have gone out after 30s or the activated **Auto Power Off** function has turned it off, it can be reactivated at any time by pressing the shutter button (16).

SIGNAL TONES

With the Leica M, you can decide whether you want warning messages that appear in the monitor and the self-timer countdown to be accompanied by an acoustic signal – two volumes are available – or whether operation of the camera should be largely silent.

Note:

The factory default setting for signal tones is **Off**.

Setting the functions

1. In the main menu (see p. 154/246) select **ACOUSTIC SIGNAL** (page 5, **SETUP** section).
2. You can now select **Off**, **Low volume** or **High volume**.

BASIC PICTURE SETTINGS

TURNING LENS TYPE IDENTIFICATION ON/OFF

The 6-bit coding in the bayonet fastening of current Leica M lenses allows the Leica M to identify the type of lens fitted using the sensor in the bayonet socket.

- Among other things, this information is used to optimize the picture data. Thus edge darkening which can be noticeable with wide-angle lenses and large apertures can be compensated in the corresponding picture data.
- Flash exposure and reflector control also use the lens data (see "Compatible flash units", p. 190).
- In addition, the information provided by this 6-bit coding is written to the EXIF file for the picture. When displaying extended image data, the lens focal length is also shown (see p. p. 238).

Note:

When using lenses without 6-bit coding, the identification function must be deactivated to prevent malfunctions, or the lens type used must be entered manually (next section).

Setting the function

1. In the main menu (see p. 154/246) select **Lens Detection** (page 1, **CAMERA** section), and
2. Select the desired option in the sub-menu:
 - **Off**, or
 - **Automatic**, if a coded lens is attached, or
 - **Manual**, if a non-coded lens is attached.

MANUAL LENS TYPE / FOCAL LENGTH ENTRY

The camera is unable to recognize previous Leica M lenses as they have no identification. However, this "identification" can be carried out in the menu.

The same applies to Leica R lenses, which can be used on the Leica M with a Leica R adapter M (for further details, refer to the adapter instructions).

3. Select the lens you are using from the list in the **Manual** sub-menu.
 - The monitor shows a list of lenses, which also includes the relevant item numbers to ensure clear identification. The camera detects whether an M lens is attached, or a Leica R lens using the adapter. The list contains either only M or only R lenses accordingly.

Notes:

- On many lenses, the item number is engraved on the reverse side of the depth of field scale.
- The list contains lenses that were available without coding (prior to around June 2006). Lenses introduced more recently are only available with coding and therefore cannot be selected manually.
- When using the Leica Tri-Elmar-M 16-18-21mm f/4 ASPH., the set focal length is not transferred to the camera and thus is not included in the EXIF data for pictures. If required, you can enter the relevant focal length manually.
- By contrast, the Leica Tri-Elmar-M 28-35-50mm f/4 ASPH. features mechanical transfer of the set focal length to the camera, necessary to display the appropriate bright line frame in the viewfinder. It is detected by the camera electronics and used for focal length specific compensation. However, only one item number - 11 625 - is listed in the menu for reasons of space. Of course, the other two versions - 11 890 and 11 894 - can be used and the settings made in the menu also apply to them.

COMPRESSION RATE / FILE FORMAT

The picture data is recorded either

- a. Using one of two different JPEG compression rates - **JPEG fine** / **JPEG standard**, or
- b. In the **DNG** file format, either compressed or uncompressed, or
- c. Using combinations of one of the two JPEG compression rates and the set DNG format, i.e. two files are generated per picture.

On the one hand this allows you to take account of the intended usage and the available memory card capacity, and on the other hand provides the security and flexibility essential for deciding on the usage later.

Setting the function

Selecting the JPEG compression or format combination

1. In the picture parameters menu (see p. 154/246) select **File format**, and
2. In the relevant sub-menu, select the desired compression / combination.

Selecting the DNG compression

1. In the main menu (see p. 154/246) select **DNG compression** (page 2, **IMAGE** section), and
2. Select the required option in the sub-menu (**On** [=compressed] / **Off** [=uncompressed]).

Notes:

- The standardized DNG (Digital Negative) format is used for storage of completely unprocessed raw picture data.
- The available compression for DNG format
 - is loss-free, i.e. it does not cause any deterioration in quality
 - retains all of the post-editing performed on the image data
 - allows faster saving
 - takes up less memory space.
- If simultaneous storage of picture data as DNG and JPEG is selected, the existing resolution setting is used for the JPEG format, i.e. the resolutions of the two files can be quite different.
- A high compression rate, such as with **JPEG standard**, can result in fine structures in the subject being lost or incorrectly reproduced (artifacts; e.g. "stepped" diagonal edges).
- The remaining number of pictures shown in the monitor does not necessarily change after every picture. This depends on the subject; with JPEG files very fine structures result in higher quantities of data, homogeneous surfaces in lower quantities.

RESOLUTION

The picture data can be recorded in JPEG format at four different resolutions. This allows you to adjust the setting precisely to the intended use or to the available memory card capacity. At the highest resolution (which also means the largest data volume), which you should select for optimum quality for large prints, a card can hold significantly fewer pictures than at the lowest resolution.

Setting the function

1. In the picture parameters menu (see p. 154/246) select **JPEG resolution**, and
2. Select the desired resolution in the sub-menu.









Note:

In DNG format, the resolution is 24MP, i.e. regardless of any different setting made for JPEG format.

WHITE BALANCE

In digital photography, white balance ensures neutral rendition of color in any light. It is based on the camera being preset to reproduce a particular light color as white.

With the Leica M, you can choose from ten different settings:

- **Automatic** – for automatic control, which delivers neutral results in most situations.
- Seven fixed presets for the most frequent light sources:
 -  Daylight - e.g. for outdoor pictures in sunshine,
 -  Cloud - e.g. for outdoor pictures with cloudy skies,
 -  Shadow - e.g. for outdoor pictures with the main subject in shadow,
 -  Artificial light - e.g. for indoor pictures with (prevailing) incandescent lamp light
 -  Warm fluorescent - e.g. for indoor pictures with (prevailing) light from fluorescent tubes, for example for homes with warm light similar to incandescent lamps at approx. 2700K
 -  Cool fluorescent - e.g. for indoor pictures with (prevailing) light from fluorescent tubes, for example for working areas and external lighting with cool light at approx. 4000K
 -  Flash - e.g. for pictures with electronic flash lighting,
-  **Gray card** – for manual setting by metering and
- **Color temperature**¹ – for a directly adjustable color temperature value.

Note:

Setting to Automatic allows the white balance to be adjusted for correct color reproduction when using an electronic flash unit that satisfies the technical requirements of System 3000 System Camera Adaption (SCA) and has an SCA-3502 adapter or a corresponding integrated foot.

However, if other flash units are used, which are not specially designed for the Leica M and do not automatically adjust the white balance, the  Flash setting should be used.

Setting the function

For automatic or fixed settings

1. In the picture parameters menu (see p. 154/246) select **White Balance**, and
2. Select the desired function in the sub-menu.

¹ All color temperatures are specified in Kelvin.

For direct setting of color temperature

You can set values between 2000 and 13100 (K¹) directly (from 2000 to 5000K in increments of 100, from 5000 to 8000K in increments of 200 and from 8000 to 13100K in increments of 300). This provides you with a broad scope, covering almost all color temperatures that can occur in practice and within which you can adapt the color reproduction very sensitively to the existing light color and/or your personal preferences.

1. In the picture parameters menu (see p. 154/246) select **White Balance** and
2. In the sub-menu select the **Color temperature** option.
3. Use the setting dial (29) or press up/down on the direction pad (30) to select the desired value, and
4. Confirm your setting with the **INFO** (31) or **SET** button (20).

For manual setting by metering

1. In the picture parameters menu (see p. 154/246) select **White Balance**, and
2. In the sub-menu select the  **Gray card** option.
 - The message **Please take a picture for setting the white balance** appears in the monitor.

3. Take the picture, making sure that the image field contains a white or neutral gray (reference) surface.
 - The monitor shows
 - the image based on the automatic white balance setting
 - cross hairs in the center of the image
4. Press the direction pad in the desired direction to move the cross hairs to the subject detail you want to use as the basis for the new white balance setting (e.g. the reference surface mentioned above).
5. Press the **INFO** button.
 - The reproduction of color in the image is adjusted accordingly.
6. You can now either
 - apply this new white balance setting, by pressing the **SET** button,
 - the message **White balance set** appears in the monitor
 - or make any number of further settings, as described under 4. and 5.

A value set in this way remains saved for and will be used for all pictures until it is superseded by a new metered value or you use one of the other white balance settings.

Note:

In parallel to a saved white balance setting, the picture is saved with the corresponding color reproduction instead of the original picture.

ISO SENSITIVITY

The ISO setting on the Leica M covers a range of ISO 200 – 6400 in $\frac{1}{3}$ ISO increments, and thus enables you to adapt the shutter speed / aperture values to the relevant situation as required.

The **Pull 100** has the same brightness as a sensitivity of ISO 100. However, pictures taken using this setting have a lower contrast range. When using this sensitivity setting, it is important to make sure that important parts of the image are not overexposed.

As well as the fixed settings, the Leica M also features the **Auto**¹ function, in which the camera automatically adjusts the sensitivity to the ambient brightness. In conjunction with aperture priority mode (see p. 182) this extends the range for automatic exposure control. However, when using the function it is also possible to specify priorities, for example for compositional reasons.

Note:

In large and evenly bright subject areas image noise as well as horizontal and vertical stripes may become visible, especially when using high ISO sensitivities and subsequently processing the image. Accordingly, these settings are identified by an additional Push.

¹ The function is not available with a manual exposure setting and when using flash units (always $\frac{1}{180}$ S).

Setting the function

Using the ISO button

1. Press the **ISO** button (22).
 - The corresponding sub-menu appears in the monitor (34).
2. While holding down the **ISO** button, use the setting dial (29) or press up/down on the direction pad (30) to select the desired sensitivity or the automatic setting.

Note:

When you release the **ISO** button, the sub-menu remains visible for around 2s. However, the set value is applied immediately.

Using the menu

1. In the picture parameters menu (see p. 154/246) select **ISO**, and
2. Use the setting dial (29) or press up/down on the direction pad (30) to set the desired sensitivity or select the automatic setting.
3. Confirm your setting by pressing the **SET** button or the **INFO** button.

To set the sensitivity automatically

In the 2nd step, select **Auto**, and

3. Call up the corresponding sub-menu.
 - This contains three options - **OK**, **Set maximum ISO** and **Set maximum exposure time**.

To use unrestricted automatic setting

4. In this sub-menu, select **OK**.

By factory default, the automatic setting uses sensitivities up to **ISO 800** and shutter speeds of up to **1/Focal length**.

Note:

By factory default, the **Maximum ISO** function is limited to **ISO 800**.

To restrict the automatic setting range

4. In this sub-menu, select **Set maximum ISO** and/or **Set maximum exposure time**.

- Selecting **Set maximum ISO** displays a list of available values, while **Set maximum exposure time** displays a further sub-menu containing the alternatives **1/Focal length** and **Manual setting**.

5. In the **Set maximum ISO** sub-menu, select the highest sensitivity to be used, and thus the range within which the automatic setting will operate, or in the **Set maximum exposure time** sub-menu select either **1/Focal length**² if you want to leave it up to the camera to ensure blur-free shutter speeds, or **Manual setting**.

When using **1/Focal length** does not switch to a higher sensitivity if the shutter speed would fall below the **1/Focal length** threshold due to lower brightness, e.g. at slower speeds than 1/60s with a 50mm lens.

6. In the **Manual setting** sub-menu, select the slowest shutter speed you want to specify (**1/2s** - **1/500s**; in whole steps).
7. Confirm your setting by pressing the **SET** or **INFO** button.

Note:

When using automatic bracketing (see p. 186) the following rule applies:

The sensitivity automatically determined by the camera for the uncorrected picture is also used for all other pictures in a series, i.e. this ISO value is not changed during a series. This may mean that the slowest shutter speed specified under **Set maximum exposure time** is exceeded.

² This function requires the use of coded lenses or setting of the lens type used in the menu (see p. 162).

Note:

The functions and settings described in the next two sections refer exclusively to pictures in one of the JPEG formats. If one of the two DNG formats is specified, these settings have no effect, as in this case the picture data is always saved in its original form.

PICTURE PROPERTIES / CONTRAST, SHARPNESS, COLOR SATURATION

In digital photography, key picture properties can be changed very easily. While photographic software – after recording and transfer to a computer – provides great scope for doing this, the Leica M itself allows you to influence three of the most important picture properties even before taking the picture:

- The contrast, i.e. the difference between light and dark areas, determines whether a picture has a more “matt” or “glossy” effect. As a consequence, the contrast can be influenced by increasing or reducing this difference, i.e. by lighter reproduction of light sections of the image and darker reproduction of dark sections.

- Sharp reproduction – at least of the main subject – using the correct distance setting is a prerequisite for a successfully picture. In turn, the impression of sharpness of a picture is to a great extent determined by the sharpness of the edges, i.e. by how small the transition area between light and dark is at the edges in the picture. The impression of sharpness can thus be changed by expanding or reducing these areas.
- The color saturation determines whether the colors in the picture tend to appear as "pale" and pastel-like or "bright" and colorful. While the lighting and weather conditions (hazy/clear) are given as conditions for the picture, there is definite scope for influencing the reproduction.
- All three picture properties can be adjusted – independently - to five different levels using the menu, so that you can set the optimum values for any situation, i.e. the prevailing lighting conditions.

Setting the functions

1. In the main menu (see p. 154/246) select **Sharpness**, **Saturation**, or **Contrast** (all on page 2, **IMAGE** section), and
2. Select the desired setting in the sub-menu.

FILM STYLES

Two of the three film style settings on the Leica M can be used to give your pictures the characteristics of particular earlier film materials, e.g. in terms of color reproduction. The third setting produces B&W pictures.

Setting the functions

1. In the main menu (see p. 154/246) select **Film mode** (page 2, **IMAGE** section), and
2. Select the desired option in the relevant sub-menu, or **Off**.

WORKING COLOR SPACE

The requirements in terms of color reproduction differ considerably for the various possible uses of digital picture files. Different color spaces have therefore been developed, such as the standard RGB (red/green/blue) that is perfectly adequate for simple printing. For more demanding image processing using appropriate software, e.g. for color correction, Adobe® RGB has become established as the standard in the relevant sectors.

Setting the function

1. In the main menu (see p. 154/246) select **Color Space** (page 2, **IMAGE** section), and
2. Select the desired function in the sub-menu.

Notes:

- If you want to have your prints produced by major photographic laboratories, mini labs or Internet picture services, you should select the sRGB setting.
- The Adobe RGB setting is only recommended for professional image processing in completely color-calibrated working environments.

THE BRIGHT-LINE VIEW AND RANGEFINDER

The Leica M's bright line view and range finder is not only a very high-quality, large, brilliant and bright viewfinder, it is also an extremely accurate range finder coupled to the lens. It has a magnification factor of 0.68x.

The bright-line frame is illuminated by LEDs - with a choice of red or white. This enables it to be seen perfectly in all lighting conditions and for all subjects.

Selecting the bright-line frame color

1. In the main menu (see p. 154/246) select **Frameline Color** (page 3, **SETUP** section), and
2. Select the desired color in the sub-menu.

When using lenses with focal lengths of 28 (Elmarit from serial number 2 411 001), 35, 50, 75, 90, and 135mm, the relevant frame is automatically illuminated in the combinations 28+90mm, 35+135mm, and 50+75mm. All lenses with focal lengths from 16 to 135mm connect with the range finder when fitted on the camera. The size of the bright-line frame is matched to the initial format on the Leica M and thus corresponds to a sensor size of 23.9 x 35.8mm at a range setting of 2m. It is linked to the range setting to ensure that the parallax - the offset between the lens and the viewfinder axis - is automatically compensated. The bright-line frame and the picture image are largely congruent over the entire distance range from 0.7m to ∞ . This means that at a range of below 2m the sensor generally detects slightly less than shown by the inner edges of the bright-line frame, and slightly more at longer ranges (see adjacent diagram). These slight variations, which are hardly ever critical in practice, are due to the operating principle.

Bright-line frames on a viewfinder camera must be matched to the image angle of the relevant lens focal lengths. However, the nominal image angles change slightly when focusing due to the changing extension, i.e. the distance between the optical system and the sensor plane. If the set range is less than infinity (and the extension correspondingly greater), the actual image angle is smaller - the lens captures less of the subject. In addition, the differences in the image angle tend to be greater at longer focal lengths, as a result of the greater extension. In the middle of the viewfinder image is the square range metering image, which is brighter than the surrounding image field. If the exposure meter is turned on, the exposure meter LEDs and the flash symbol LED appear at the lower edge of the viewfinder image.

For more details about setting the range and exposure metering, as well as flash mode, refer to the relevant sections on p. 174/ 179.

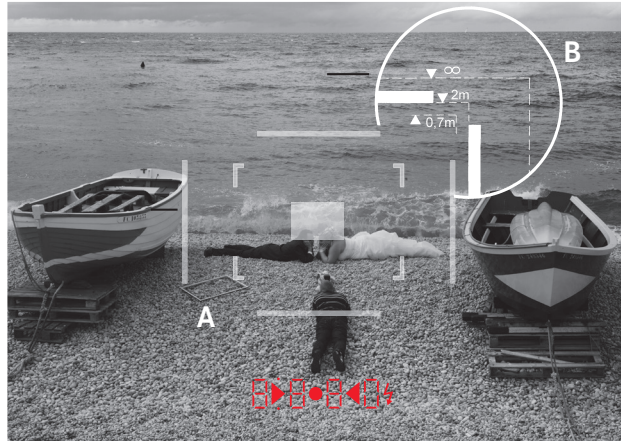

All pictures and bright-line frame positions relative to 50mm focal length

A	Bright-line frame
B	Actual image field
Set to 0.7m:	The sensor detects approx. one frame width less.
Set to 2m:	The sensor detects exactly the image field shown by the inner edges of the bright-line frame.
Set to infinity:	The sensor detects approx. 1 or 4 (vertical or horizontal) frame width(s) more.

THE MONITOR

The Leica M features a large 3" LCD color monitor (34), protected by a glass cover made of exceptionally hard and scratch resistant Gorilla® Glass¹.

In picture mode with the live view function activated (see p. 173) it shows the image detected by the sensor through the attached lens. In review mode, it is used to view the pictures taken on the memory card.

In both cases, it shows the entire image field, along with the selected data and information (see p. 204).

Setting the brightness

The brightness of the monitor image can be set using the menu. You can choose from automatic control, i.e. depending on the ambient brightness, and five manual levels, so that you can adapt it perfectly to the relevant situation:

1. In the main menu (see p. 154/246) select **Monitor** **Brightness** (page 3, **SETUP** section), and
2. Select the automatic setting or the desired level in the sub-menu.

Notes:

- With the exception of the menu system (see p. 154) you can (optionally) view all of the displays described in this manual in exactly the same way in an attached electronic viewfinder (the Leica EVF2, available as an accessory, see p. 224)
- The **EVF Brightness** option in the menu (**Main Menu**, page 3, **SETUP** section, see p. 154/246) can be used to set the brightness of this kind of viewfinder in exactly the same way as described above.

¹ Gorilla® Glass is a registered trademark of Corning Incorporated.

LIVE VIEW MODE

Live view mode on the Leica M enables you to view the subject in the monitor when taking a picture, with a precise indication of how the attached lens will capture it. It is also a prerequisite for using particular focusing methods (see p. 177) and exposure metering methods (see p. 180).

The **LV** button (25) is used to turn live view mode on and off.

Review brightness

The monitor image normally has a uniform brightness, i.e.

- as long as the subject brightness
- and the set exposure do not result in exceptionally low or high brightness values
- and the internal exposure time in live view mode is not longer than $1/30\text{s}$.

As soon as you press the shutter button to the first pressure point, the monitor image instead displays the subject with the brightness that is produced by the relevant exposure setting.

By default, the live view monitor image contains some fundamental information in a header. You can use the **INFO** button (27) to display additional information (see p. 240).

Note:

- Live view mode is based on the image captured by the sensor. To use it, the shutter must be open and it is closed and re-cocked when the function is cancelled. Of course, this is audible and results in a slight delay in the shutter button.
- When used frequently, live view mode results in increased power consumption.

RANGE MEASUREMENT

The Leica M provides you with various tools for setting the range, depending on whether you are using the camera's internal optical viewfinder (26) and/or live view mode (see p. 174).

Notes:

- The electronic displays are based on the image captured by the sensor. To use it, the shutter must be open and it is closed and re-cocked when the function is cancelled. Of course, this is audible and may result in a slight delay in the shutter release, and also results in increased power consumption if used frequently.
- Due to the different sensitivities and function conditions, there may be differences between the optimum settings and those displayed.

With the optical range finder

Due to its large effective metering basis, the range finder on the Leica M is very precise. The benefits of this are particularly noticeable when using wide-angle lenses with their relatively high depth of field.

Mechanical metering basis (Distance between the optical axes of the viewfinder window and the range finder viewing window)	× viewfinder magnification	= Effective metering basis
69.25mm	x 0.68	= approx. 47.1mm

The range finder metering field is visible as a bright, sharply defined rectangle in the center of the viewfinder. The focus can be set using either the superimposed image or split image method.

Superimposed image method (double image)

In a portrait, for example, aim the metering field at the eye and turn the distance setting ring on the lens until the contours in the metering field are brought into line. Then choose the subject detail.

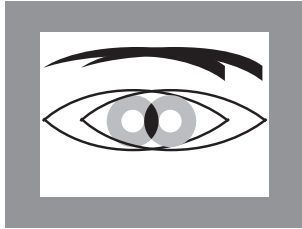

Out of focus

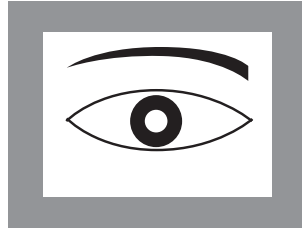

In focus

Split image method

When taking photographs of architecture, for example, aim the range finder metering field at the vertical edge or another clearly defined vertical line and turn the distance setting ring on the lens until the contours of the edge or line can be seen at the limits of the metering field with no misalignment. Then choose the subject detail.

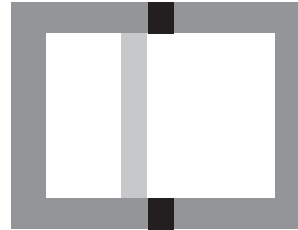

Out of focus

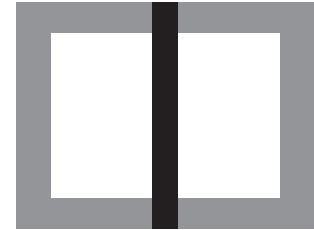

In focus

Note:

The following two functions are also available with Leica R lenses, i.e. not only with Leica M lenses with 6-bit coding and Leica M lenses selected using the menu.

With the monitor image in live view mode

In live view mode (see p. 174) you can set the sharpness using the monitor image, as it displays the subject with exactly the same sharpness as is produced by the lens depending on the range and aperture setting.

Procedure

1. Turn on live view mode using the **LV** button (25).
2. Use the focusing ring on the lens (14) to focus on the desired subject details.

To make the setting easier and increase the accuracy of the setting, you can enlarge a central detail of the monitor image. You can call up this function in two ways.

For occasional use:

1. Press the focus button (3).
 - The monitor image shows
 - the enlarged detail
 - the setting dial symbol with the possible enlargement / reduction directions
 - the current zoom factor.You can change the zoom factor using the setting dial - either 5x or 10x.
2. Use the focusing ring on the lens (14) to focus on the desired subject details.

For continuous use:

1. In the main menu (see p. 154/246) select **Focus Aid** (page 3, **SETUP** section), and
2. Select **On** in the sub-menu.
 - As soon as you turn the focusing ring on the lens (14), the enlarged detail described above appears.

You can change the enlargement as required using the setting dial (29) or call up the unenlarged 1x view of the entire monitor area.

With indication of in focus subject details in the monitor image



In live view mode on the Leica M you can mark subject details with optimum focus in the monitor image, which makes them very easy to identify.

Procedure

1. In the main menu (see p. 154/246) select **Focus Peaking** (page 4, **SETUP** section), and
2. Select **On** in the sub-menu.
3. Turn on live view mode using the **LV** button (25).
4. Select your trimming.
5. Press the focus button (3) or turn the focusing ring on the lens (14) so that the desired subject details are marked.
 - All subject details that are in focus at the set range are indicated by red outlines.

Important:

This function is based on the subject contrast, i.e. light/dark differences. Therefore, subject details that are not completely in focus but have a high contrast may also be marked.

TURNING THE EXPOSURE METER ON / OFF

The exposure meter is turned on by tapping the shutter button (16), provided the camera is turned on at the main switch (15) and the shutter speed dial (18) is not set to **B**.

The displays in the viewfinder or monitor light up continuously to indicate that the exposure meter is ready:

- in aperture priority mode the LED display of the shutter speed,
- and in manual mode one of the two triangular LEDs in the viewfinder lights up, either individually or in conjunction with the center circular LED, while the light balance is displayed in the monitor.

If you let go of the shutter button without activating the shutter, the exposure meter remains turned on for around 30s more, and the relevant LED(s) remain lit for the same time.

If the shutter speed dial is set to **B** the exposure meter is disabled.

Notes:

- In aperture priority mode, if correct exposure cannot be achieved using the available shutter speeds, the shutter speed display gives a warning by flashing (only in the viewfinder, for more details, refer to the "Aperture priority mode" section on p. 182).
- If the exposure meter reading is below the metering range in very low lighting conditions and in manual mode, the left hand triangular LED in the viewfinder flashes as a warning, or the left-hand bar of the light balance flashes in the monitor. In aperture priority mode, the shutter speed is still displayed. If the required shutter speed falls below the slowest possible setting of 32s, this display also flashes in the viewfinder.
- If the camera is out of use for an extended period or is stored in a case, always turn it off at the main switch. This also prevents pictures from being taken accidentally.

Note:

With many light sources (particularly LED and sodium vapor lamps), alternating current causes fluctuations in brightness, which are invisible to the eye. Because of the sensitivity and reading frequency of image sensors, this can cause the monitor image to flicker or result in strips in video recordings (not in photos). Selecting a slower shutter speed can avoid the effect for the picture.

EXPOSURE METERING METHODS

Two metering methods are available on the Leica M:

- Strongly center-weighted metering in **Classic** mode. This method takes account of the entire image field, although the parts of the subject situated in the center have more influence on the exposure value calculation than the areas at the margins.
- The light reflected by a bright shutter diaphragm blade in the first shutter curtain is captured by a photo diode and measured.
- A choice of spot, center weighted and multi-field metering in **Advanced** mode or using live view mode (see p. 174). Metering with the picture sensor is a prerequisite for this.

Required preliminary setting if not using live view mode

1. In the main menu (see p. 154/246) select **Light Metering Mode** (page 1, **CAMERA** section), and
2. In the sub-menu select
 - **Classic** shutter metering, for the conventional metering method described above, or
 - **Advanced** sensor metering if you want to be able to choose between the three metering methods described below.

Note:

In live view mode, the three metering methods are always available, i.e. even if Classic is set.

Selecting the metering method

1. In the picture parameters menu (see p. 154/246), select **Exposure metering** and
 2. Select the desired metering method in the sub-menu:
 - **Spot** Only a small area in the center of the image is captured and evaluated. This area is indicated by the rectangle in the center of the monitor image.
 - **Center-weighted** Similar to the **Classic** center weighting described above.
 - **Multi-field** This metering method is based on detection of multiple metered values. The values are used in an algorithm to calculate an exposure value appropriate to the situation, resulting in correct reproduction of the assumed main subject.
- The set metering method is specified in the monitor in live view and video mode, and in the extended (**INFO**) display (see p. 246)

Notes:

- For the metering methods based on the image sensor, the shutter must be open and it is then closed and re-cocked when the function is cancelled. Of course, this is audible and may result in a slight delay in the shutter release.
- When used frequently, live view mode results in increased power consumption.

The appropriate shutter speed for correct exposure, or the variation from a correct exposure setting, are specified or determined using displays in the viewfinder or monitor (see following sections).

EXPOSURE MODES

The Leica M provides two exposure modes: Aperture priority mode and manual mode. Depending on the subject, situation and your individual preferences, you can thus choose between

- the familiar “semi automatic” operation, or
- setting a fixed shutter speed and aperture.

APERTURE PRIORITY

If the shutter speed dial (18) is in the **A** position, the camera electronics automatically set the appropriate shutter speed, continuously in the range $1/4000\text{s}$ to 60s, depending on the set sensitivity, the measured brightness and the manually selected aperture. The calculated shutter speed is displayed in half steps to provide a better overview.

For shutter speeds slower than 2s the remaining exposure time is counted down and displayed in seconds after the shutter release. The actually generated and continuously controlled exposure time can however vary from the half step value displayed: For example, if the display shows **1/6** (the closest value) before releasing the shutter, but the calculated exposure time is longer, the countdown after releasing the shutter may actually start from **1/5**.

Under extreme lighting conditions, based on all the parameters the exposure meter may generate a shutter speed that is outside the working range, i.e. brightness values that would require shorter exposures than $1/4000\text{s}$ or longer than 60s. In such cases the specified minimum or maximum shutter speed is nevertheless used, and these values flash in the viewfinder as a warning.

Notes:

- As described in connection with the ISO setting on p. 167, a certain amount of noise becomes apparent when using higher sensitivities, and particularly with uniform dark surfaces. To reduce this annoying phenomenon, after pictures with slow shutter speeds and high ISO values the Leica M automatically takes a second “black picture” (taken with the shutter closed). The noise present in this parallel picture is then digitally “subtracted” from the data for the real picture. As a result, the message **Noise reduction** appears for **1/2s**¹ in the monitor. This doubling of the “exposure” time can be significant at longer exposure times, and must be allowed for. During this time the camera should not be turned off.
- If the **B** function is used in conjunction with the self-timer (see p. 188), there is no need to keep the shutter release button pressed; the shutter will remain open until the shutter release button is pressed a second time (this is then equivalent to a **T** function).

¹ Time data is an example

EXPOSURE LOCK

For compositional reasons, the most important part of the subject is often not in the center of the picture, and as a result such important parts of the subject may be excessively light or dark. However, the center-weighted metering and spot metering on the Leica M record predominantly or exclusively an area in the center of the image are calibrated to an average gray scale value.

Subjects and situations of this type can be overcome very easily even in aperture priority mode, using exposure lock.

Note:

Exposure lock should not be used in conjunction with multi-field metering, as in such cases selective recording of a single subject detail is not possible.

Using the function

1. Aim at the important subject detail (with the metering field for spot metering) or alternatively at another detail with average brightness.
2. Press the shutter release button (1.19) to the 1st pressure point to measure and store the value. As long as the pressure point is held, a small red dot appears in the viewfinder at the top in the digits line for confirmation, and the exposure time no longer changes even if the lighting conditions are different. A dot appears between the ISO and exposure compensation values in the monitor.
3. Keeping the shutter release pressed, move the camera to capture the final trimming,
4. The shutter can then be released using the exposure originally determined.

Changing the aperture setting after using exposure lock has no effect on the shutter speed, and will lead to an incorrect exposure. Exposure lock is cancelled when you let go of from the shutter button

EXPOSURE COMPENSATION

Exposure meters are calibrated to an average gray scale value (18% reflection), which corresponds to the brightness of a normal, i.e. average photographic subject. If the actual subject detail does not match this assumption, an appropriate exposure compensation can be performed.

Particularly when taking several pictures in succession, for instance if for any reason a series of pictures is taken deliberately using slight under or overexposure, exposure compensation is a very useful function: In contrast to exposure lock, once set it remains effective until it is reset.

On the Leica M, exposure compensation can be set in the range $\pm 3\text{EV}$ in $\frac{1}{3}\text{EV}$ increments (EV: Exposure Value).

Entering and cancelling an exposure compensation

The Leica M provides three options for setting an exposure compensation. You can make the setting using the menu or the setting dial.

Setting using the menu is recommended if, for example, you know before taking a series of pictures that you want your subjects to be slightly under or overexposed. The exceptionally fast option using the setting dial is ideal when unexpected situations occur and enables you to track your subject in the viewfinder without interruptions.

A. Using the menu

1. In the picture parameters menu (see p. 154/246), select **Exposure compensation**.
 - A scale appears in the monitor instead of a sub-menu, with an EV value indicated in red and a white triangle to indicate the relevant setting. If they are at a value of 0, this means that the function is deactivated.
2. Set the desired value.
 - In the initial menu list, a set compensation is indicated by **EV±X¹**.

B. Using the setting dial

1. Hold down the focus button (3).
 - The current setting is displayed digitally in the viewfinder. If no compensation value is set, **0.0** appears.
2. Use the setting dial (29) to set the desired compensation value.
 - The compensation value in the viewfinder changes accordingly, for example **1.0** / **0.5**, while the monitor (in live view mode) displays both the compensation value and the resulting changed shutter speed.

Important:

An exposure compensation set on the camera only influences metering of the available light, i.e. not flash light (for more information about flash photography, refer to the sections starting on p. 191).

Regardless of how the set compensation was originally entered:

- It remains effective until it is manually reset to 0, regardless of whether the camera has been turned off and back on in the meantime.
- It can be reset using either the menu or the setting dial.
- It is displayed in the form of EV values in the picture parameters menu and in the monitor in live view mode, and in the form of changed shutter speeds and a flashing dot at the bottom in the viewfinder.

¹ Example, either plus or minus, "X" stands for the relevant value

AUTOMATIC BRACKETING

Many attractive subjects are very rich in contrast, i.e. they have both very light and very dark areas. The effect can be quite different, depending on which sections you base your exposure on. In such cases, the automatic bracketing function in aperture priority mode on the Leica M enables you to produce several alternatives with graduated exposure, i.e. using different shutter speeds. You can then select the most suitable picture for further use, or use appropriate software to create a picture with an exceptionally high contrast range (HDR).

The following are available:

- 4 graduations: **0.5EV**, **1EV**, **1.5EV** and **2EV**
- 2 numbers of pictures: 3 or 5

Setting the function

1. In the main menu (see p. 154/246), select **Bracketing** (page 1, **CAMERA** section).
 - A sub-menu containing the three options **Frames**, **Aperture stops**, and **Automatic** is displayed in the monitor, with a scale below.
If an exposure compensation is set at the same time, this is indicated by a corresponding value below the scale.
2. When using **Frames** select whether you want to use bracketing and the number of pictures to use.
 - White triangles appear above the selected intervals marked in red in the scale. They specify the relevant exposure values.
3. Confirm the setting.
 - The setting for **Aperture stops** is marked as ready for editing.
4. Select the desired function graduation.
 - The marked intervals and the triangles change positions according to the selected graduation.

Notes:

- If the bracketing exceeds the range of $\pm 3\text{EV}$ - due to the combination of the number of pictures and graduation - the scale division changes from $\pm 3\text{EV}$ to $\pm 6\text{EV}$. The intervals and triangles displayed adjust accordingly.
 - Note that both settings have to be made and confirmed, otherwise the function will not be active.
5. Confirm the setting.
 - The setting for **Automatic** is marked as ready for editing.
 6. Select the desired setting, **On** to start bracketing automatically when the shutter is released once, **Off** to release the shutter individually for each picture.
 7. Confirm the setting.
 - Set bracketing is indicated by **xEV/x¹** in the initial menu list.
 8. Pressing the shutter release button once or several times (see p. 150) produces all pictures.

Notes:

- The following rule applies when using automatic bracketing:
The sensitivity determined automatically by the camera for the uncorrected picture is also used for all other pictures in a series, i.e. this ISO value is not changed during bracketing.
This may mean that the slowest shutter speed specified under **Set maximum exposure time** is exceeded.
- Depending on the initial shutter speed, the working range for automatic bracketing may be limited.
- Regardless of this, the specified number of pictures are **always** taken, which may mean that several pictures in a series have the same exposure.
- Automatic bracketing is also possible when using flash. This is irrespective of the flash unit's charge state, therefore the exposure series may contain shots both with and without flash illumination.
- The function itself remains active until it is deactivated in the **Pictures** sub-menu. If it is not deactivated, another series of pictures is taken each time the shutter release button is pressed.

¹ Example, first "x" stands for the graduation, the second for the number of pictures

MANUAL EXPOSURE SETTING

If the exposure setting is performed entirely manually, the shutter speed dial (18) must be clicked to one of the engraved exposure times or to one of the intermediate values.

Then:

1. Turn on the exposure meter, and
2. Turn the shutter speed dial and /or the aperture setting ring (11) on the lens – in each case in the direction indicated by the triangular LED that is lit up – until only the circular LED is lit up.

As well as the direction of rotation of the shutter speed setting dial and aperture setting ring necessary for correct exposure, the three LEDs in the light balance also indicate underexposure, overexposure and correct exposure in the following way:

- ▶ Underexposure by at least one aperture stop; turning to the right is required
- ▶● Underexposure by $1/2$ aperture stop; turning to the right is required
- Correct exposure
- ◀ Overexposure by $1/2$ aperture stop; turning to the left is required
- ◀ Overexposure by at least one aperture stop; turning to the left is required

Note:

For shutter speeds slower than 2s the remaining exposure time is counted down and displayed in seconds after the shutter is released

THE B SETTING / T FUNCTION

With the **B** setting, the shutter remains open for as long as the shutter button is held down (up to a maximum of 60s; depending on the ISO setting).

In conjunction with the self-timer, a T function is also available: If **B** is set and the self-timer is activated by tapping the shutter button (see also p. 150), the shutter opens automatically after the selected delay time. It then remains open until you press the shutter button a second time – you do not need to hold it down. This enables you to largely prevent any blurring, even with long exposures, by pressing the shutter button.

In both cases, the exposure meter is disabled; after the shutter is released however the digital display in the viewfinder counts the elapsed exposure time in seconds, for guidance.

Fixed settings for slow shutter speeds

1. Hold down the focus button (3).
 - The shutter speed sub-menu appears in the monitor. Available shutter speeds – depending on the ISO sensitivity – are marked in white, those that are unavailable in gray.
2. Use the setting dial or the direction pad (left/right) to select the desired shutter speed.
 - The sub-menu is displayed for a further 2s after the focus button is released.
3. Release the shutter.

Notes:

- Long exposure times can be associated with very heavy picture noise.
- To reduce this annoying phenomenon, following exposures with slower shutter speeds (below approx. $1/30$ s, differing depending on other menu settings) the Leica M automatically takes a second "black picture" (with the shutter closed). The noise present in this parallel picture is then digitally "subtracted" from the data for the real picture.
- This doubling of the "exposure" time can be significant at longer exposure times, and must be allowed for. During this time the camera should not be turned off.
- At shutter speeds of more than 2s, the message **Noise reduction 12s¹** appears in the monitor.

¹ Time data is an example

VALUES ABOVE AND BELOW THE METERING RANGE

If the exposure meter reading is below its working range in very low lighting conditions and in manual mode, the left hand triangular LED (▶) flashes as a warning in the viewfinder, while the right hand LED (◀) does the same if there is too much light. In aperture priority mode, the shutter speed is still displayed. If the required shutter speed is less than 60s or more than $1/4000$ s, these displays also flash. As the exposure is metered with the working aperture, this situation can come about by stopping down the lens.

Even if you are below the metering range, the exposure meter remains on for around 30s after you let go of the shutter button. If the lighting conditions improve in this time (e.g. through a change in the subject detail or opening of the aperture), the LED display changes from flashing to continuously lit, indicating that the meter is ready.

FLASH OPERATION

The Leica M determines the necessary flash power by firing one or more ranging flashes, fractions of a second before taking the actual picture. Immediately after this, at the start of exposure, the main flash is fired.

All factors that influence the exposure (such as picture filter and changes to the aperture setting) are automatically taken into account.

COMPATIBLE FLASH UNITS

The following flash units, when used on the Leica M, are capable of all the functions described in this manual, including TTL flash metering:

- The Leica SF 58 system flash unit (order no. 14 488). With a maximum guide number of 58 (in 105mm setting), an automatically controlled zoom reflector (with coded Leica M lenses, see p. 147), automatic short synchronization with shutter speeds faster than $1/180$ s for HSS flash (see p. 194), an optional second reflector, and many other functions, it is both powerful and versatile. Thanks to its permanently attached flash foot with additional control and signal contacts, which are used to automatically transfer a range of data and settings, it is very easy to use.

- The Leica SF 26 system flash unit. The ideal solution thanks to its compact dimensions and design geared to the camera. Like the Leica SF 58, it has a permanently attached flash foot with all contacts and is also very easy to operate.
- Flash units that satisfy the technical requirements for System 3000 System Camera Adaption (SCA), are fitted with the SCA-3502-M5 adapter¹, allow guide number control, and are HSS compatible (see p. 194).

Other commercially available flash attachments with standard flash foot² and positive center contact, and fired by the center contact (X contact, 19) can also be used. We recommend the use of modern thyristor-controlled electronic flash units.

¹ When using the SCA-3502-M5 adapter, white balance (see p. 165) can be set to Automatic for correct color reproduction.

² However, if flash units not specially designed for the Leica M are used and do not automatically adjust the white balance on the camera, the  setting should be used (see p. 165).

ATTACHING THE FLASH UNIT

- Before attaching a flash unit to the flash shoe (19) on the Leica M,
- the cover that protects the flash shoe and the socket (27) when not in use, must be detached to the rear, and
 - the camera and flash unit must be turned off.

When attaching a flash unit, you should ensure that the foot of the flash unit is fully inserted into the flash shoe and the clamping nut is tightened to prevent it accidentally falling out. This is particularly important for flash units with additional control and signal contacts, because if the position in the flash shoe changes the necessary contacts can be broken, leading to malfunctions.

Notes:

- This also applies when using a flash unit with SCA adapter set (see p. 226).
- Make sure the flash shoe cover is always attached when no accessory is being used (such as a flash unit, an external viewfinder, or the microphone). It protects the socket 27 against the ingress of water for a limited time.

FLASH MODE

Fully automatic flash mode, i.e. controlled by the camera, is available on the Leica M with the system compatible flash units listed in the previous section, and in aperture priority **A** and manual exposure modes.

In addition, automatic illumination control is operational in all three exposure modes. This means that in order to ensure a balanced relationship between flash and available light at all times, the flash power is reduced by up to $1\frac{2}{3}$ EV as ambient brightness increases.

However, if the ambient brightness plus even the shortest possible flash sync time of $\frac{1}{180}$ s would cause overexposure, a non-HSS compatible flash unit will not be fired in aperture priority mode. In such cases the shutter speed is governed by the ambient brightness and is shown in the viewfinder.

In aperture priority mode **A** and with manual setting, the Leica M also allows the use of creative flash techniques such as synchronization of flash firing with the 2nd shutter curtain rather than the 1st, as is usual, and flash with slower shutter speeds than the sync speed of $\frac{1}{180}$ s. These functions are set on the camera using the menu (for more details, refer to the relevant sections below).

In addition the Leica M transfers the set sensitivity to the flash unit. This allows the flash unit, provided it has received such information and the aperture manually set on the lens is also input to the flash unit, automatically to adjust its range values accordingly. With system compatible flash units, the sensitivity setting cannot be influenced from the flash unit as it is transferred from the camera.

Notes:

- Studio flash systems may have a very long burning time. Therefore, when using them it may be useful to select a slower shutter speed than $1/180\text{s}$.
- The same applies to radio controlled flash triggers for "unchained flash", as the radio transmission can cause a delay.
- The following sections describe only those settings and functions that are available when using the Leica M with system compatible flash units.
- An exposure compensation set on the camera (see p. 184) only influences the measurement of available light. If you want to simultaneously use compensation of the TTL flash exposure metering in flash mode – in parallel or in the opposite direction, you must make this additional setting (on the flash unit).
- More details of flash use, in particular for other flash units not specially adapted to the Leica M and for different flash modes can be found in the relevant manuals.

Settings for camera-controlled automatic flash mode

After the flash unit in use has been turned on and set to the operating mode for GNC (= Guide Number Control), the following actions on the Leica M are necessary:

1. Before taking each flash picture the exposure metering is first performed by gently pressing the shutter release, so that the display in the viewfinder shows the shutter speed or switches to the light balance. If this stage is missed out by fully depressing the shutter release in one quick movement, the flash unit will not fire even if required.
2. The shutter speed dial must be set to **A**, to the flash sync speed ($1/180\text{s}$), or to a slower shutter speed (including **B**). In aperture priority mode, the camera automatically switches to the flash sync speed set in the menu or the speed range (see "Selecting the sync speed/the sync speed range", p. 194). The shortest flash sync speed must be taken into account as this determines whether a "normal" flash is fired or an HSS flash (see p. 194).
3. The desired aperture, or the aperture required for the relevant distance to the subject, must be set.

Note:



If the automatically controlled or manually set shutter speed is faster than $1/180$ s, the flash is not fired unless the flash unit is HSS compatible (see p. 194).



Flash exposure displays in the viewfinder with system-compatible flash units

A flash-shaped LED (2.1.3) appears in the camera viewfinder as confirmation and to display the various operating conditions. This LED appears together with the displays for exposure metering for the ambient light level, described in the relevant sections.



In automatic flash mode

(flash unit set to Guide Number Control)

-  does not appear although the flash unit is turned on and ready to use:
A faster shutter speed than $1/180$ s is set manually on the camera and the connected flash unit is not HSS compatible. In such cases, the Leica M will not fire the flash unit even though it is turned on and ready to use.
-  flashes slowly (2Hz) before taking the picture:
The flash unit is not yet ready to use.
-  lights up before taking the picture:
The flash unit is ready to use

-  remains continuously lit after firing but the rest of the displays have disappeared:
Flash exposure was OK, the flash is still ready to use.
-  flashes quickly (4Hz) after firing but the rest of the displays have disappeared:
Flash exposure was OK, but the flash is not yet ready to use again.
-  disappears along with the rest of the displays after firing:
Underexposure, e.g. due to the selected aperture being too small for the subject. If the flash unit is set to a partial discharge power, because of the lower power requirement it may be ready for use despite the flash LED not lighting up.

When the flash unit is set to camera control (A) or manual mode (M)

-  does not appear although the flash unit is turned on and ready to use:
A faster shutter speed than $1/180$ s is set manually on the camera. In such cases, the Leica M will not fire the flash unit even though it is turned on and ready to use.
-  flashes slowly (2Hz) before taking the picture:
The flash unit is not yet ready to use.
-  lights up before taking the picture:
The flash unit is ready to use

LINEAR FLASH MODE (HIGH SPEED SYNCHRONIZATION)

Fully automatic, i.e. camera controlled, linear flash operation is available with the Leica M when using the Leica SF 58 flash unit, with all shutter speeds and in aperture priority and manual exposure modes. The camera activates it automatically if the selected or calculated shutter speed is faster than the sync speed, i.e. $\leq 1/180\text{s}$. If the flash unit is set correctly, this change does not require the photographer to do anything else.

Important:

The range for HSS flash is significantly lower than for TTL flash.

SELECTING THE SYNC SPEED / THE SYNC SPEED RANGE

Reproduction of the available light is determined by the shutter speed and the aperture. A fixed setting to the fastest possible shutter speed for flash operation, the sync time, leads unnecessarily in many situations to a greater or lesser underexposure of all parts of the subject not directly lit by the flash.

The Leica M allows you to combine flash operation with the shutter speed generated in aperture priority mode to subtly change the lighting conditions for the relevant subject to suit your compositional ideas. You can choose any of five ways of doing this:

Setting the function

1. In the main menu (see p. 154/246), **Auto Slow Sync** (page 1, **CAMERA** section), and
2. Select the automatic lens-specific setting - **1/Focal length**¹, or whether you want to specify a particular shutter speed yourself - Manual setting - in the sub-menu.
3. In the Manual setting sub-menu, set the range of shutter speeds permitted by specifying the fastest speed permitted.

Notes:

- **1/Focal length** results in the slowest shutter speeds based on the rule of thumb for blur-free pictures taken from the hand, e.g. $1/60\text{s}$ with a 50mm lens. However, in the **Auto Slow Sync** menu it is limited to $1/125\text{s}$, even if the focal length used is longer.
- The setting field in the **Manual setting** sub-menu initially shows the current slowest shutter speed setting.
- Manual exposure control also allows any shutter speed up to the sync speed $1/180\text{s}$ to be set.
- If the Leica SF 58 (see p. 190) is being used and faster shutter speeds are set on the camera, i.e. $\leq 1/180\text{s}$, the flash unit automatically switches to HSS mode.

¹ Only when using Leica M lenses with 6-bit coding in the bayonet and lens identification enabled in the menu.

SELECTING THE FIRING MOMENT

Flash photographs are illuminated by two light sources, the available light and the light from the flash. Parts of the subject that are exclusively or primarily illuminated by the flash are almost always reproduced sharply (with correct focusing) due to the extremely fast pulse of light. By contrast, all other parts of the subject – those that are sufficiently illuminated by the available light or illuminate themselves – are portrayed with different degrees of sharpness in the same picture. Whether these parts of the subject are reproduced sharply or “blurred”, and the degree of blurring, is determined by two independent factors.

1. The shutter speed, i.e. for how long these parts of the subject “act upon” the sensor, and
2. How quickly these parts of the subject – or the camera itself – are moving during exposure.

The longer the exposure time or the faster this movement, the greater the extent to which the two – superimposed – parts of the picture can differ.

With the conventional time for firing the flash, at the beginning of the exposure, i.e. immediately after the 1st shutter curtain has completely opened the image window. This can actually lead to visible contradictions, e.g. in the picture of the motorcycle, which is being overtaken by its own light trail.

The Leica M allows you to choose between this conventional firing moment and synchronization with the end of the exposure, i.e. immediately before the 2nd shutter curtain starts to close the image window again. In this case, the sharp image reflects the end of the movement captured. In the photograph, this flash technique gives a natural impression of movement and dynamics.

The function is available

- for all camera and flash unit settings
- when using the flash unit on the camera or with the SCA adapter set
- in aperture priority mode and with manual shutter speed selection
- in automatic and manual flash mode

The displays are identical in both cases.

Setting the function

1. In the main menu (see p. 154/246) select **Flash Sync. Mode** (page 1, **CAMERA** section), and
2. Select the desired option in the sub-menu.

ADDITIONAL FUNCTIONS

VIDEO RECORDINGS

You can also use the Leica M to produce video recordings. The following functions are available:

Resolution

1. In the picture parameters menu (see p. 154/246), select **Video Resolution**, and
2. Select the desired setting in the sub-menu. Each of the three resolutions can be combined with two different image frequencies to match reproduction to the TV system used, 25 fps for PAL, 24 and 30 fps for NTSC.

ISO sensitivity

All the settings listed on pages 167-168 but with the restriction described below in respect of the shutter speeds

Note:

In the case of dark subjects containing small and very bright light sources, horizontal and vertical stripes may become visible in any part of the image, especially when using high ISO sensitivities.

Distance setting

All options described on pages 175-178

Exposure metering methods

All options described on page 180

Exposure modes

- Aperture priority (see p. 182)
- Manual control with shutter speeds of $1/30^{-1}/4000\text{s}$. Set slower shutter speeds are dealt with in the same way as $1/30\text{s}$.

Color space

Video recordings are only possible with sRGB (see p. 170).

Saturation, Contrast, Film styles

All options described on page 169.

Note:

To ensure a consistent exposure, you should use manual shutter speed settings, otherwise changes in the subject, e.g. movements, could cause troublesome brightness fluctuations.

Starting / Ending the recording

A recording starts the first time you press the video shutter release (17) and ends when you press it again.

- A video recording in progress is indicated in the monitor by a flashing red dot and the elapsed recording time in live view mode (see page). In the viewfinder, it is indicated by alternate flashing of the two dots in the digital display.

As video recordings on the Leica M are made in 16:9 or (with VGA resolution) in 4:3 format, black strips appear in the monitor. These are above and below the image in the former case, to the left and right in the latter.

Individual pictures can still be taken while a video recording is in progress. Pressing the shutter release button interrupts the video recording for the duration of the photo. Individual pictures are taken with the relevant settings on the camera.

SOUND RECORDING

Sound recordings using the built-in microphone (9) are made in mono. An external microphone is available as an accessory for stereo recording (see p. 227).

Setting the function

1. In the main menu (see p. 154/246) select **Audio** (page 4, **SETUP** section).
 - The sub-menu contains the options **Audio Adjustment** and **Wind Elimination**.

To influence the sound, you can choose from two options or a manual setting, which you can use to regulate the level or deactivate sound recording.

2. In the Audio settings sub-menu, select **Standard**, **Concert**, or **Manual**.
 - If you have selected **Manual**, next to the microphone symbol (🎤) and the current level (B), you will see a bar chart
 - indicating the current level (C)
 - the peak value¹ (D)
 - a full modulation marking (E)

Manual setting

3. Set the level using the setting dial (29) - left = lower / right = higher - or by pressing up/down on the direction pad (30). This can also be done during the recording if you have previously pressed the **INFO** button (31). Level 0 means no sound recording.

To prevent over modulation, you should select the level at which the peak value does not exceed the full modulation marking at all, or only slightly/infrequently. This is illustrated by the indicators C and D being white above this marking and red below it.

Note:

For mono recordings, both sides (= channels) in the bar chart run parallel, or separately for stereo recording.

Even for stereo recordings, the level is not controlled separately for each channel.

To reduce any noise caused by wind during the sound recording, two levels of damping are available.

2. In the **Wind Elimination** sub-menu, select **Off**, **Medium** or **High**.
Whenever no wind noise is feared, you should select **Off** to ensure optimum sound.

TAKING PHOTOGRAPHS WITH THE SELF-TIMER

You can use the self-timer to take a picture with a delay of either 2 or 12s. This can be particularly useful, for example in the first case if you want to avoid the picture being out of focus due to camera shake when releasing the shutter or, in the second case, for group photographs where you want to appear in the picture yourself.

Setting and using the function

1. Turn the main switch (15) to **ON**.
2. In the main menu (see p. 154/246) select **Self-timer** (page 1, **CAMERA** section) and
3. Select the required delay time in the associated sub-menu.
4. To start the delay time, press the shutter button (16) to the 2nd pressure point (see p. 151).
 - The LED (7) on the front of the camera flashes for the first 10s of a 12s delay time to show the progress of the delay time. The countdown is shown in the monitor at the same time.

While the 12s self-timer delay time is running, it can be cancelled at any time by pressing the **SET** (17) or **MENU** (18) button - the relevant setting is retained and the function can be restarted by pressing one of the shutter button again.

Important:

In self-timer mode, the exposure is not set by pressing the shutter button to the pressure point, it is set immediately before the picture is taken.

MARKING THE PICTURE FILES FOR COPYRIGHT PROTECTION

The Leica M enables you to mark your picture files by entering text or other characters.

You can enter up to 17 characters of information under 2 headings for each picture.

1. In the main menu (see p. 154/246) select **Copyright information** (page 4, **SETUP** section).
 - A sub-menu containing the options **Copyright information**, **Information** and **Artist** appears in the monitor. Only the **Copyright information** line is initially activated.
2. Turn on the **Copyright information** function and confirm the operation.
 - The information lines are activated and the first position is marked as ready for editing.
3. Use the setting dial (29) to select the desired characters and press the relevant direction on the direction pad (30) to move between positions.

You move to the **Artist** lines either by pressing the appropriate directions on the direction pad or using the **INFO** (31) or **SET** button (20).

The available characters include various punctuation marks, numbers from 0 to 9, upper and lower case letters and a space , which appear in this order in an endless loop.

4. Confirm your setting by pressing the **SET** or **INFO** button.

RECORDING THE LOCATION WITH GPS





This option is only available if the multifunction hand grip is attached (available as accessory, see p. 226).

The Global Position System enables the current position of the receiver to be determined worldwide. The multifunction hand grip is equipped with an appropriate receiver. If the hand grip is attached to the Leica M, when the function is activated the camera continuously receives the corresponding signals and updates the position data. You can write this information - latitude and longitude, height above sea level - to the "EXIF" data.

Note:

The corresponding menu function on the camera is only available when the multifunction hand grip is attached.

Setting the function

1. In the main camera menu, select **GPS** (page 4 / **SETUP** section), and
2. Select **On** or **OFF**.
 - The satellite symbol  in the camera monitor indicates the status (only with picture data display):
 -  = Last position determined up to 1 min ago
 -  = Last position determined up to 24hrs ago
 -  = Last position determined at least 24hrs ago, or no position data available

Notes on the function:

- The GPS aerial is located at the top of the multifunction M hand grip.
- GPS positioning requires as clear a path as possible between this aerial and the sky. We therefore recommend holding the camera with the GPS aerial pointing vertically upwards.
- Make sure that the GPS aerial is not covered with your hand or any other item, particularly metal objects.
- It may not be possible to receive good signals from GPS satellites at the following locations or in the following situations. In such cases, either no positioning or only incorrect positioning is possible.
 - In closed rooms
 - Underground
 - Under trees
 - In a moving vehicle
 - Close to high buildings or in steep valleys
 - Close to high voltage cables
 - In tunnels
 - Close to 1.5 GHz cell phones
 - With accessories attached to the flash shoe, e.g. a flash unit

Information for safe use

The electromagnetic field generated by the GPS system can influence instruments and measuring equipment. Therefore, make sure the GPS function is deactivated on board an aircraft before takeoff or landing, in hospitals or in other locations where there are restrictions on wireless transmissions.

Important (legal restrictions on use):

- In certain countries or regions, the use of GPS and associated technologies may be restricted. Therefore, before travelling in other countries you should consult the relevant country's embassy or your travel agent.
- The use of GPS inside the People's Republic of China and Cuba and close to their borders (exceptions: Hong Kong and Macao) is prohibited by national laws.
- Violations will be prosecuted by the authorities. The GPS function is therefore deactivated automatically in these areas.

VIRTUAL HORIZON

Thanks to integrated sensors, the Leica M can represent its alignment in the monitor (34). The corresponding display can be called up as required. It enables you to align the camera precisely in the longitudinal and transverse axis to capture critical subjects, e.g. architecture pictures from a tripod.

Setting the function

In the main menu (see p. 154/246) select **Horizon** (page 4/ **SETUP** section).

- A vertical scale and a horizontal bar appear in the monitor. Variations from the relevant zero positions are indicated graphically– by red markings – and the horizontal alignment in the longitudinal and transverse axis by a central green marking. The corresponding figures are also specified.

Note:

The monitor image remains visible until it is deactivated by pressing one of the shutter button (16/18) or the **MENU** button (21).

USER / APPLICATION SPECIFIC PROFILES

On the Leica M, any combination of menu settings can be permanently stored, e.g. so that they can be retrieved quickly and easily at any time for recurring situations / subjects. A total of four memory slots are available for these combinations, as well as a factory default setting that can be retrieved at any time and cannot be changed. You can change the names of the saved profiles. Profiles set on the camera can be transferred onto one of the memory cards, for example for use in other camera units, while profiles stored on a card can be transferred onto the camera.

Saving settings / Creating a profile

1. Set the desired functions in the menu.
2. In the picture parameters menu (see p. 154/246) select **User profile**,
3. Select **Save as user profile** in the sub-menu, and
4. Select a memory slot in the sub-menu.

Selecting a profile

1. In the picture parameters menu (see p. 154/246) select **User profile**.
 - If user profiles are stored, the profile name appears in gray, while free memory slots are green.
2. Select the required profile in the sub-menu, either one of the saved profiles, or **Default user profile**.

Note:

If you change one of the settings for the profile currently in use — appears instead of the name of the profile you were previously using in the initial menu list.

Renaming profiles

1. In the picture parameters menu (see p. 154/246) select **User profile**.
2. Select **Manage profiles** in the sub-menu, and
3. Select **Rename profiles** in the sub-menu.
 - The profile name and name appear, with the number marked as ready for editing.
4. Select the profile to be renamed by turning the setting dial (29) or pressing up or down on the direction pad (30).
5. Confirm your setting by pressing the **SET** (20) or **INFO** button (31) or by pressing right on the direction pad.
 - The next position is marked as ready for setting.
6. The numbers and letters in the name are changed by turning the setting dial or by pressing up and down on the direction pad, while you select different positions by pressing either
 - the **INFO** button,
 - or the **SET** button,
 - or left / right on the direction pad.The available characters are upper case letters from **A** to **Z**, numbers from **0** to **9** and a space **▢**, and you can scroll through them in an endless loop..
7. Confirm your setting - only possible if the last position is active - by pressing the **SET** or **INFO** button.

Saving profiles to a card / transferring profiles from a card

1. In the picture parameters menu (see p. 154/246) select **User profile**,
2. Select **Manage profiles** in the sub-menu, and
3. Select **Import profiles from card** or **Export profiles to card**.
 - A confirmation prompt appears in the monitor.
4. Confirm your setting by pressing the **SET** (20) or **INFO** (31) button, and confirm that you really want to import or export the profile(s).

Note:

When exporting, all profile slots are transferred to the card, i.e. including any empty profiles. As a result, when importing profiles any existing profiles in the camera will be overwritten, i.e. deleted.

RESETTING ALL CUSTOM SETTINGS

This function allows you to delete all previous custom settings in the main and picture parameters menus at once, and reset them to the factory default settings.

Setting the function

1. In the main menu (see p. 154/246) select **Reset** (page 5/**SETUP** section), and
2. Select **No** or **Yes** in the sub-menu.

Note:

This reset also affects any stored individual user profiles defined.

¹ The peak value display shows the maximum value for the last 5s.

REVIEW MODE

To review pictures in the monitor (34) on the Leica M, you can select:

- **PLAY** Review for an unlimited time

or

- **Auto Review** Brief review immediately after taking the picture

REVIEW FOR UNLIMITED TIME – PLAY

You can press the **PLAY** button (24) to switch to review mode.

- The last picture taken appears in the monitor along with the corresponding displays (see p. 242).
However, if the memory card inserted does not contain any picture files, a corresponding message appears when you switch to review mode: **Attention: No image to display.**

Notes:

- Depending on the function previously set, pressing the **PLAY** button generates different responses:

Initial situation	After pressing the PLAY button
a. Full review display of a picture	Picture mode
b. Review of an enlarged section / several reduced pictures (see p. 210)	Full review display of the picture
c. One of the menu controls (see p. 154), or DELETE or delete protection function (see p. 212/213) is activated	Full review display of the last displayed picture

- The Leica M can only review picture data taken with cameras of this type.

AUTOMATIC REVIEW OF LAST PICTURE

In **Auto review** mode, every picture is displayed immediately after it is taken.

This allows you to quickly and easily check whether the picture was successful or needs to be taken again.

This function enables you to select the time for which the picture will be displayed.

Setting the function

1. In the main menu (see p. 154/246) select **Auto review** (page 4 / **SETUP** section),
2. In the associated sub-menu select the desired function or time: (**Off**, **1 second**, **3 seconds**, **5 seconds**, **Continuous**, **Shutter release pressed**).

From **Auto review** mode, you can switch back to normal, i.e. unlimited time, **PLAY** mode at any time

Note:

If you have been taking photographs using the picture series function (see p. 152) in both review modes the last picture in the series or the last picture in the series stored on the card - if not all pictures in the series have been transferred from the camera's internal back-up memory to the card at this point- is displayed first. Details of how to select the other pictures in the series and further options in review mode are described in the sections below.

Normal review

To allow uninterrupted viewing of the pictures, only the information in the header appears in normal review mode



If a detail is shown, the header disappears and a corresponding display appears .

Video review

If a video recording is selected, this is indicated by .



To play back a video, press the **INFO** button (31) to call up the next view, which contains corresponding control symbols.



- 1** Back to beginning
- 2** Fast rewind
- 3** Play/Pause
- 4** Fast forward
- 5** To end
- 6** Exit view

Select the desired function by pressing right/left on the direction pad (30) or using the setting dial (29). It is activated by pressing the **SET** button (20), either by pressing it or, for fast forward/rewind, holding it down. This starts in slow motion and gets faster the longer the button is held down for.

- The currently active function symbol is shown in white and underlined in red.

Note:

From this view, the menu for protecting (see p. 214) cannot be called up. To do this, switch to another view by pressing the **INFO** button.

In addition to normal review, a further three (for individual pictures) or 2 (for video recordings) options with different additional information are available. All 4 or 3 options are in an endless loop and can be selected by (repeatedly) pressing the **INFO** button.

Review with histogram

Press the **INFO** button once (starting from normal review mode), to display the histogram. It appears in the lower half of the picture. You can choose between two types of histogram: Either related to the total brightness (**Standard**), or related to the three color channels red/green/blue (**RGB**).

Setting the function

1. In the main menu (see p. 154/246) select **Histogram** (page 3, **SETUP** section), and
2. Select the desired option in the sub-menu.



Notes:

- The histogram is available when viewing both the entire picture and just one section of it (see p. 208), but not when viewing several reduced pictures simultaneously (see p. 211).
- The histogram always relates to the section of the picture currently displayed (see p. 208).
- However, the **RGB** histogram is not available in live view mode.

Review with clipping indicators

You can use the menu to set the clipping thresholds for displaying both the light and dark areas.

Press the **INFO** button twice (starting from normal review mode), to display the areas without marking.

- Excessively light areas are indicated in red, excessively dark areas in blue, flashing in each case. The clipping symbol (L) also appears in the bottom right.



Setting the function

1. In the main menu (see p. 154/246) select **Clipping setting** (page 3 / **SETUP** section), and
2. Set the upper and lower thresholds in the sub-menu.
 - The scale shows the clipping areas relative to the overall exposure range.

The following then appears in the pictures:

- Excessively dark areas are marked in blue, excessive bright areas in red, flashing in each case.

Notes:

- The clipping indicators are available when viewing both the entire picture and a section of it, but not when simultaneously viewing 4, 9 or 36 reduced pictures (see p. 211).
- The clipping indicators always relate to the section of the picture currently displayed (see p. 211).

Review with additional information

Press the **INFO** button three times (starting from normal review mode) to display additional picture data and a reduced picture.



Note:

This review option only allows you to view the entire picture, even if only a section was previously selected.

VIEWING OTHER PICTURES / "SCROLLING" IN THE MEMORY

You can open other saved pictures by pressing left and right on the direction pad (30). Pressing left takes you to earlier pictures, pressing right to later pictures. After the first and last picture, the series of pictures begins again in an endless loop, which means you can reach all pictures in either direction.

- The picture and file numbers in the monitor change accordingly.



ENLARGING / SELECTING THE TRIMMING / SIMULTANEOUSLY VIEWING SEVERAL REDUCED PICTURES

With the Leica M it is possible to open an enlarged section of an individual picture in the monitor to study it more closely, with a free choice of section. Conversely, you can also view up to 36 pictures simultaneously in the monitor, e.g. to gain an overview or to find the picture you are looking for more quickly.

Notes:

- Not all zoom levels are available for pictures with low resolution, e.g. 1.7 MP.
- While an enlarged picture is displayed, left/right on the direction pad are no longer available to open other pictures, instead they are used to "navigate" within the picture. (exception: see next note).

Turning the setting dial (29) to the right enlarges a central trimmed area. Enlargement is possible up to 1:1, i.e. until 1 pixel of the monitor displays 1 pixel of the picture.

The four directions on the direction pad (30) can be used to select any position for the section to be enlarged. To do this, press the direction (several times) in which you want to shift the section.

- In addition to the enlargement, the rectangle within the frame in the top right-hand corner of the monitor symbolizes the position of the section displayed.

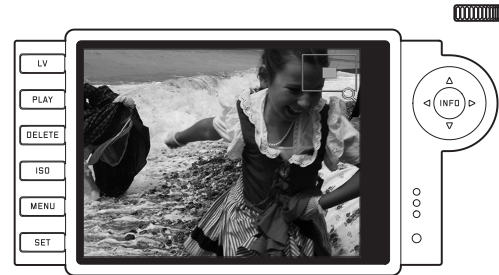
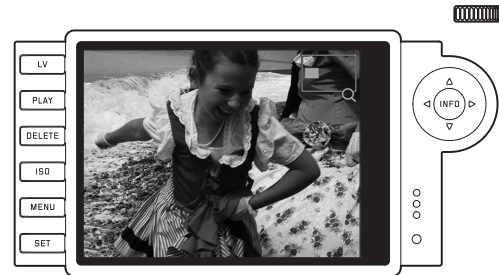

Note:

You can also switch from an enlarged picture directly to another picture, which will then be shown at the same enlargement. This is done by pressing left or right on the direction pad - but while holding down the **PLAY** button (24).

By turning the setting dial to the left (starting from normal size), you can simultaneously view 4 - or by turning the dial further 9 or 36 - pictures in the monitor.

- Up to 36 reduced images are shown in the monitor including the picture previously being viewed at normal size, which is marked with a red border.

You can use the four directions on the direction pad to navigate freely among the reduced images, and the relevant image is marked accordingly. You can return this picture to normal size by turning the setting dial to the right or by pressing the **INFO** or **PLAY** button.

Note:

When 36 pictures are displayed, turning the setting dial further to the right places the red frame around the entire group of pictures, which then allows you to "scroll" more quickly, a block at a time.

DELETING PICTURES

When a picture is displayed in the monitor, you have an opportunity to delete it if you wish to do so. This can be useful, for example if the pictures have already been saved to other media, if you no longer require them or if you need to free up more space on the memory card.

The Leica M allows you to delete single pictures, or all pictures at the same time, as required.

Notes:

- Deleting is only possible in review mode, but regardless of whether a picture is being displayed at normal size or several reduced pictures are displayed (but not if the 36 picture review is activated with a red frame around the entire block, see p. 211).
- For protected pictures, the protection must first be cancelled before they can be deleted (see also next section).

Procedure

1. Press the **DELETE** button (21).
 - The corresponding sub-menu appears in the monitor.



Note:

The delete process can be cancelled at any time using the **PLAY** (24) or **DELETE** button.

2. The first step is to decide whether you want to delete individual pictures - **Delete single** - or all pictures at once - **Delete all**.
3. Confirm your selection with the **SET** button. You can still open other pictures by pressing right and left on the direction pad.

Notes:

- If the picture displayed is protected (see p. 213), the **Single** option cannot be selected in the sub-menu.
- When deleting all pictures, to prevent accidental deletion there is an intermediate step in which you must reconfirm that you definitely want to delete all pictures on the memory card.

Displays after deleting

After deleting, the subsequent picture appears. If there are no more pictures saved on the card, the following message appears: **Attention No image to display**.

DELETING ALL PICTURES ON THE MEMORY CARD

After deleting, the following message appears: **Attention No image to display**. However, if one or more pictures were protected, that picture or the first of those pictures then appears.

Note:

When a picture is deleted, the subsequent pictures in the picture counter are re-numbered as follows: For example, if you delete picture no. 3, what was previously picture no. 4 then becomes no. 3, the previous no. 5 becomes no. 4 etc. However, this does not apply to the picture numbering on the memory card.

PROTECTING PICTURES / CLEARING DELETE PROTECTION

The pictures stored on the memory card can be protected against accidental deletion. This protection can then be cleared at any time.

Notes:

- Pictures can only be protected, or the protection can only be cleared, in review mode, irrespective of whether a picture is displayed at normal size or as one of several reduced pictures (but not when viewing 36 pictures with a red frame round the entire block, see p. 211).
- For details of the different procedures/responses when you attempt to delete protected pictures, refer to the previous section.
- If you decide you want to delete them, clear the protection as described below.
- Protection is only effective on the Leica M.
- Even protected pictures are deleted if the memory card is reformatted (see next section for details).
- On SD/SDHC/SDXC memory cards, you can prevent accidental deletion by sliding the protection switch on the card (see p. 145) to the position marked LOCK.

Procedure

1. Press the **SET** button (20).
 - The corresponding sub-menu appears in the monitor.

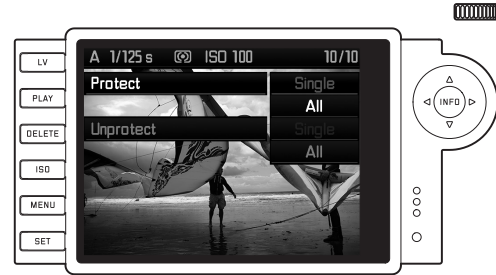

Note:

The setting process can be cancelled at any time

- either by pressing the **PLAY** button (24) - to return to normal review mode,
- or by tapping one of the two shutter button (16/17) to go to picture mode.

2. Select

- whether you want to protect individual pictures **Protect single**, or
- simultaneously protect all pictures **Protect all**, or
- whether you want to clear the existing protection for individual pictures **Clear protection single**, or
- for all pictures **Clear protection all**.

Note:

The following functions cannot be performed and the menu text appears in dark instead of light gray to indicate this:

- Protecting a picture that is already protected
- Clearing delete protection for a picture that is not protected

3. Confirm your selection with the **SET** button. You can still open other pictures by pressing right and left on the direction pad (30).

Displays after protection /Clearing delete protection

After completing the process, the original monitor display appears again, with the corresponding symbol (Ⓢ) for protected pictures.

Note:

The display (Ⓢ) also appears if a protected picture is called up.

ADDITIONAL FUNCTIONS

FOLDER MANAGEMENT

The picture data on the memory card is stored in folders, which are created automatically. The folder names always consist of eight characters - three figures and five letters. In the factory default setting, the first folder is named "100LEICA", the second "101LEICA", etc. The next available number is always used as the folder number, and a maximum of 999 folders are possible. If the number capacity has been used up, a corresponding warning message appears in the monitor.

Within the folder, the individual pictures are given continuous numbers up to 9999 unless a the memory card in use already contains a picture with a higher number than the last number assigned by the camera. In such cases, the numbering used on the card is continued. If the current folder contains picture number 9999, a new folder is created automatically and the numbering begins again at 0001. If folder number 999 and picture number 9999 are reached, a corresponding warning message appears in the monitor and the numbering must be reset (see below).

On the Leica M you can also create new folders at any time, give them names of your choice and change the file names.

Changing folder names

1. In the main menu (see p. 154/246) select **Image numbering** (page 4 / **SETUP** section), and
2. Select **New folder** in the sub-menu.
 - The folder name appears (initially always **XXX1LEICA**). The fourth character is marked as ready for editing. Positions 4-8 can be changed.

Note:

If you are using a memory card that was not formatted with this camera (see p. 218), the camera automatically creates a new folder.

3. The numbers and letters are changed by turning the setting dial (29) or by pressing up and down on the direction pad (30), while you select different positions by pressing
 - the **INFO** button (31),
 - or the **SET** button (20),
 - or left / right on the direction pad.The available characters are upper case letters from **A** to **Z**, numbers from **0** to **9** and the underscore **_**, and you can scroll through them in an endless loop.

4. Confirm your settings - only possible if the eighth character is active - by pressing the **SET** or **INFO** button.
 - A further sub-menu appears, showing **Reset image numbering?**.
5. Select **Yes** or **No**.

Changing picture file names

1. In the main menu (see p. 154/246) select **Image numbering** (page 4 / **SETUP** section), and
2. Select **Change file name** in the sub-menu.
 - The name of the picture file appears. The first character is marked as ready for editing.
Positions 1-4 can be changed.
3. The numbers and letters are changed by turning the setting dial (29) or by pressing up and down on the direction pad (30), while you select different positions by pressing
 - the **INFO** button (31),
 - or the **SET** button (20),
 - or left / right on the direction pad.The available characters are upper case letters from **A** to **Z**, numbers from **0** to **9** and the underscore **_**, and you can scroll through them in an endless loop.
4. Confirm your settings - only possible if the fourth character is active - by pressing the **SET** or **INFO** button.
 - The setting menu described under 2. appears again.

¹ The X characters are placeholders.

RESETTING PICTURE FILE NAMES

1. In the main menu (see p. 154/246) select **Image numbering** (page 4 / **SETUP** section), and
2. Select **Reset** in the sub-menu.
 - A further sub-menu appears, showing **Reset image numbers?**.
3. Select **Yes** or **No**.
 - After confirming your selection by pressing the **INFO** (31) or **SET** button (20), the setting menu described under 2. appears again.

FORMATTING THE MEMORY CARD

It is not normally necessary to format memory cards that have already been used. However, if a card that has yet to be formatted is inserted for the first time, it must be formatted.

Note:

You should get into the habit of copying all your pictures onto a secure bulk storage medium, e.g. the hard drive on your computer, as soon as possible. This is particularly important if the camera is being sent for servicing along with the memory card.

Procedure

1. In the main menu (see p. 154/246) select **Format SD card** (page 5, **SETUP** section), and
2. Select **Format SD card?** in the sub-menu.
3. Press the **SET** (20) or **INFO** button (31) to format the memory card.

Notes:

- If the memory card has been formatted in another device, such as a computer, you should reformat it in the camera.
- If the memory card cannot be formatted/overwritten, you should ask your dealer or the Leica Information Service (for address, see p. 254) for advice.

¹ The X characters are placeholders.

TRANSFERRING DATA TO A COMPUTER

The Leica M is compatible with the following operating systems:

- Microsoft®: Windows® XP/Vista®/7®
- Apple® Mac® OS X (10.6 or higher)

The picture data on a memory card can be transferred to a computer using the Leica M in two ways:

- With the memory card inserted in the camera
To do this, the multifunction M hand grip available as an accessory and equipped with a USB 2.0 interface (see p. 226) must be attached to the camera.
- Using a card reader for SD/SDHC/SDXC cards (see p. 145)

Notes:

- Details of how to attach the hand grip, its functions and how to use it can be found in the manual.
- Connecting two or more devices to a computer or connecting using a USB hub or extension cables can result in malfunctions.

USB CONNECTION

The Leica M allows data to be transferred via a USB cable using two different standards. It thus takes account of the fact that some programs for transferring picture data require a connection complying with the PTP protocol.

In addition, it is always possible to operate the camera as an external drive ("bulk storage").

Setting the function

1. In the **Main Menu** (see p. 154/246) select **USB mode** (page 5, **SETUP** section), and
2. Select **PTP** or **Mass Storage** in the sub-menu.

Connecting and transferring data using the PTP protocol

If the camera is set to PTP:

3. Use the USB cable (supplied with the hand grip) to connect the USB socket on the hand grip to a USB port on the computer.

With Windows®XP

- After connecting, a message appears to confirm that the Leica M has been detected as new hardware (1st connection only).
4. Double-click on the message
 - A pull-down menu entitled “M8 Digital Camera” opens for the data transfer wizard.
 5. Click on “OK” and follow the subsequent instructions in the wizard to copy the pictures to a folder of your choice in the normal way.

With Windows®Vista®/7®

- After connecting, a message for installing the device driver software appears above the taskbar.
At the same time, the USB connection appears in the camera monitor. Successful installation is confirmed by another message. The “Automatic Review” menu opens with various device options.
5. You can use the Windows wizard to "Import Images" or "Open Device to View Files" in the normal way.

With Mac® OS X (10.5 or higher)

- Once the camera has been successfully connected to the computer, “USB Connection” appears in the monitor (1.36).
5. Now open the “Finder” on the computer.
 6. In the left window, click on “Programs” in the “Locations” category.
 7. Now select the “Digital Images” program in the right window.
 - The program opens and the name “M Digital Camera” appears in the program title bar.
 8. The pictures can now be transferred to the computer using the “Load” button.

Connecting and transferring data with the camera as an external drive (bulk storage)

With Windows® operating systems:

If the camera is connected to the computer using the USB cable, the operating system detects it as an external drive and assigns it a drive letter.

With Mac® operating systems:

If the camera is connected to the computer using the USB cable, the memory card used appears as a storage medium on the desktop. With this method, the Finder can be used to access the files directly.

Note:

As long as this function is active, all other camera functions are blocked.

Important:

- Use only the USB cable supplied with the hand grip.
- While data is being transferred from the camera to the computer, the connection may not under any circumstances be broken by removing the USB cable, as otherwise the computer and/or the camera may crash, and the memory card may even be irreparably damaged.
- While data is being transferred from the camera to the computer, the camera must not be turned off or turn itself off due to a lack of battery capacity, as otherwise the computer can crash. If the capacity battery capacity runs low while transferring data, end the data transfer, turn off the camera (see p. 150) and charge the battery (see p. 141).

DATA STRUCTURE ON THE MEMORY CARD

When the data stored on a card is transferred to a computer, the following folder structure is used:

Up to 9999 pictures can be stored in each of the folders 100LEICA, 101LEICA etc.

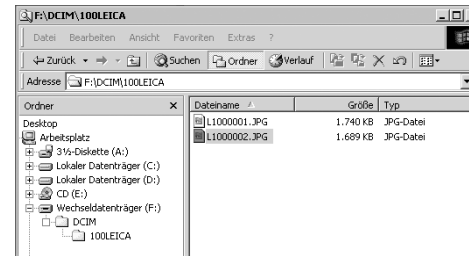

ADOBE® PHOTOSHOP® LIGHTROOM®

Adobe® Photoshop® Lightroom® is available as a free download when you register your Leica M on the Leica Camera AG home page. Further details can be found in the "Customer Area" under: <https://owners.leica-camera.com> or on the registration card in the camera packaging.

LEICA IMAGE SHUTTLE

The exclusive Leica Image Shuttle software enables you to remotely control the camera from a computer and to directly store the image data on the computer's hard drive for "tethered shooting". All of the key camera functions can be controlled. This convenient solution provides ideal support in the studio and on location.

Leica Image Shuttle is available as a free download when you register your Leica M on the Leica Camera AG home page. Further details can be found in the "Customer Area" under:

<https://owners.leica-camera.com> or on the registration card in the camera packaging.

Note:

This function is only available with the multifunction M hand grip (see p. 226) fitted.

WORKING WITH DNG RAW DATA

If you have selected DNG (Digital Negative) format, you require specialist software to convert the saved raw data into optimum quality, for example the professional raw data converter Adobe®Photoshop®Lightroom®. It provides quality optimized algorithms for digital color processing, delivering exceptionally low noise photographs with incredible resolution.

During editing, you have the option of adjusting parameters such as white balance, noise reduction, gradation, sharpness etc. to achieve an optimum image quality.

INSTALLING FIRMWARE UPDATES

Leica is constantly working on developing and optimizing its products. As many functions of the camera are entirely controlled by software, some of these improvements and extended functions can be installed at a later date.

Leica provides firmware updates at irregular intervals for this purpose. Information about any resulting changes or additions to the details in this manual can be found on our website.

To check whether your camera is running the latest firmware version, select **Firmware** in the menu (page 5 / **SETUP** section).

You can download new firmware from our home page and transfer it to your camera:

1. Format a memory card in the camera.
2. Turn off the camera and insert the card into an SD/SDHC/SDXC card reader – either integrated or connected to your computer.
3. Download the Firmware file from the Leica M site using the “UPDATES” link.
4. Save the file m-X_XXX.upd at the top level of the card's folder structure. X_XXX stands for the relevant version.
5. Remove the card from your card reader and insert it in the camera. Close the bottom cover and turn the camera on.

6. Hold down the **INFO** button (30) and turn on the camera.

The update process begins. This can take up to 15 minutes.

Note:

If the battery does not have sufficient charge, the warning message **Battery low** appears. In this case, first charge the battery and then repeat the process described above.

MISCELLANEOUS

SYSTEM ACCESSORIES FOR THE LEICA M

INTERCHANGEABLE LENSES

The Leica M system provides a basis for optimum adaptation to fast and unobtrusive photography. The range of lenses incorporates focal lengths from 16 to 135mm and light intensities up to 1:0.95.

R ADAPTER M

The Leica R adapter M allows almost all Leica R lenses to be used on the Leica M, i.e. regardless of the focal length, fixed focal length or zoom, close up limit, with which actuating cam they are equipped (SL "ramps" / R "steps") and whether or not they have a ROM contact strip.

It is also possible to use these lenses in conjunction with Leica Extender R models, and with close-up accessories such as the Leica Macro Adapter R, Leica R intermediate rings and the R BR2 automatic bellows.

This enables the Leica M to be used for applications that are not normally possible for a view and range finder camera, such as pictures with extremely short or long focal lengths, and extreme close up shots.

(Order no. 14 642)

FILTERS

UVa filters and a universal polarization filters are available for current Leica M lenses fitted with standard filter threads.

Note:

Leica UV/IR filters specially developed for use on the Leica M8 and M8.2 should not be used on the Leica M as they can cause color shifts at the edges of pictures, particularly when using wide angle lenses.

EVF2 ELECTRONIC VIEWFINDER

The EVF2 delivers almost 100% TTL reproduction of the image field with a resolution of 1.4 megapixels. This allows easy and precise picture composition and, at the same time, comprehensive control of all relevant data. It proves particularly useful if the lighting conditions impair the visibility of the monitor image and - thanks to the tilting eyepiece - for worm's eye view pictures.

(Order no. 18 753)

Note:

Make sure the flash shoe cover is always attached when no accessory is being used (such as a flash unit, an external viewfinder, or the microphone). It protects the socket 27 against the ingress of water for a limited time.

UNIVERSAL WIDE ANGLE VIEWFINDER M

The Leica universal wide-angle viewfinder M is a thoroughly practical accessory. It can be used without restriction on all analog and digital Leica M models and – just like the viewfinder in the camera – uses a reflected bright-line frame to outline the picture area for wide angle focal lengths 16, 18, 21, 24 and 28mm.

The viewfinder is equipped with parallax compensation and a vial (spirit level) for exact leveling of the camera.

(Order no. 12 011)

BRIGHT LINE FINDER M

Mirror viewfinders are available for 18, 21, and 24mm lenses. They feature an exceptionally compact design and a bright viewfinder image. Bright line frames like those in the camera viewfinder are used to select the trimming

(order no. 18mm: 12 022 black, 12 023 silver / 21mm: 12 024 black, 12 025 silver / 24mm: 12 026 black / 12 027 silver).

VIEWFINDER MAGNIFIERS M 1.25x AND M 1.4x

The Leica M 1.25x and M 1.4x viewfinder magnifiers significantly simplify picture composition when using focal lengths above 35mm. They can be used on all Leica M models and magnify the central area of the viewfinder image. The 1.25x viewfinder magnifier gives the 0.68x viewfinder on the Leica M a magnification of 0.85x, while the 1.4x gives 0.95x magnification.

A security chain with snap fasteners prevents loss and can be used to hang the viewfinder on the carrying strap's fastening ring.

The viewfinder magnifiers are supplied in a leather bag. A loop on the bag allows the viewfinder magnifier to be stored on the camera's carrying strap, where it is protected and ready for use.

(Order no. 12 004 M 1.25x, 12 006 M 1.4x)

FLASH UNITS

With a maximum guide number of 58 (in 105mm setting), an automatically controlled zoom reflector (with coded Leica M lenses, see p. 20), an optional second reflector and many other functions, the Leica SF 58 (order no. 14 488) system flash unit is both powerful and versatile. Thanks to its permanently attached flash foot with additional control and signal contacts, which are used to automatically transfer a range of data and settings, it is very easy to use.

With its compact dimensions and design that matches the camera, the Leica SF 26 system flash unit (Order no. 14 622) is the perfect solution. It is also extremely easy to operate.

SCA ADAPTER SET FOR MULTIFUNCTION M HAND GRIP

The adapter set is made up of a rail and the SCA connecting cable. Combined with an attached multifunction M hand grip, it provides TTL controlled flash, even if the flash unit will not be attached to the camera, e.g. for indirect illumination. It is also possible to use two flash units simultaneously, one on the camera, one using the adapter set.

(Order no. 14 498)

HAND GRIP M

As a practical accessory, we recommend the M hand grip, which allows you to hold the Leica M extremely steadily and to carry it with one hand. It is fitted in place of the standard bottom cover. (Order no. 14 496)

MULTIFUNCTION M HAND GRIP

As for the M hand grip. The multifunction M hand grip is also equipped with a GPS aerial, which enables the location coordinates to be added to picture data. In addition, it has connections for data transmission via USB cable, mains operation with AC adapter M, flash firing with standard commercial synchronous cables and - in conjunction with an SCA adapter set - TTL control of external, compatible flash units.

(Order no. 14 495)

MICROPHONE ADAPTER SET

The microphone adapter M allows sound recording in stereo for video recordings. When fitted to the accessory shoe on the camera, all necessary connections are made simultaneously.

(Order no. 14 634)

CORRECTIVE LENSES

For optimum adaptation of the eye to the camera's viewfinder, we offer corrective lenses with the following positive or negative diopter values (spherical): $\pm 0,5/1/1,5/2/3$.

AC ADAPTER FOR MULTIFUNCTION M HAND GRIP

The mains unit allows the camera to be continuously operated (with the multifunction M hand grip attached) directly from the mains.

(Order no. 14 497)

FINGER LOOP M FOR MULTIFUNCTION M HAND GRIP

The finger loops are screwed into the multifunction M hand grip or the M hand grip and provide a secure hold on the camera, particularly when it is being carried and when using long and heavy lenses.

(Order no. S: 14 646/M: -647/L: -648)

CASES

The new M ever-ready case has been specially developed for the new Leica M. It protects the camera reliably during transportation and can be left connected to the camera so that the camera can be used quickly when taking photographs.

For effective protection during intensive photography, the front of the case can be detached and the section remaining on the camera then acts as a camera protector.

(Order no. 14 547)

For your full set of camera equipment, the classic Billingham combination case made of waterproof fabric is also available. This either holds two cameras and two lenses or one camera and three lenses. It has enough space for even large lenses and a fitted M hand grip. A zipped compartment also provides space for a Leica SF 26 flash and for other accessories.

(Order no. 14 854 black, 14 855 khaki)

SPARE PARTS

	Order no.
Camera cover M	14 397
Accessory shoe cover M	14 644
Carrying strap	14 312
Lithium ion battery BP-SCL2	14 499
Charger for BP-SCL2 (with EU/USA mains cables, car charging cable)	14 494
Mains cable for AUS and UK	14 422 and 14 421

SAFETY AND CARE INSTRUCTIONS

GENERAL PRECAUTIONS

- Do not use the Leica M in the immediate vicinity of devices with powerful magnetic, electrostatic or electromagnetic fields (e.g. induction ovens, microwave ovens, television sets or computer monitors, video game consoles, cell phones, radio equipment).
- If you place the Leica M on or very close to a television set, its magnetic field could interfere with picture recordings.
- The same applies for use in the vicinity of cell phones.
- Strong magnetic fields, e.g. from speakers or large electric motors, can damage the stored data or the pictures.
- Do not use the Leica M in the immediate vicinity of radio transmitters or high-voltage power lines. Their magnetic fields can also interfere with picture recordings.
- If due to the effects of electromagnetic fields the Leica M malfunctions, remove the battery and turn the camera on again.
- Protect the Leica M from contact with insect sprays and other aggressive chemicals. Petroleum spirit, thinner and alcohol may not be used for cleaning.
- Certain chemicals and liquids can damage the Leica M body or the surface finish.
- As rubber and plastics sometimes emit aggressive chemicals, they should not remain in contact with the Leica M for extended periods.
- Ensure that sand and dust cannot get into the Leica M, e.g. on the beach. Sand and dust can damage the camera and the memory card. Take particular care when changing lenses and when inserting and removing the card.
- Ensure that water cannot get into the Leica M, e.g. when it is snowing or raining and on the beach. Moisture can cause malfunctions and even permanent damage to the Leica M and the memory card.
- Make sure the flash shoe cover is always attached when no accessory is being used (such as a flash unit, an external viewfinder, or the microphone). It protects the socket 27 against the ingress of water for a limited time.
- If salt water spray gets onto the Leica M, wet a soft cloth with tap water, wring it out thoroughly and wipe the camera with it. Then wipe down thoroughly with a dry cloth.

MONITOR

The monitor is manufactured using a high-precision process. This ensures that of the total of more than 921,600 pixels only a very small number will not work correctly, i.e. remain dark or always be lit. However, this is not a malfunction and it does not impair the reproduction of the picture.

- If the Leica M is exposed to significant temperature fluctuations, condensation can form on the monitor. Wipe it carefully with a soft dry cloth.
- If the Leica M is very cold when it is turned on, the displays may at first appear darker than usual. As soon as it warms up, it will reach its normal level of brightness.

SENSOR

- Cosmic radiation (e.g. on flights) can cause pixel defects.

CONDENSATION MOISTURE

- If condensation has formed on or in the Leica M, you should turn it off and leave it to stand at room temperature for around an hour. Once the camera temperature has adjusted to room temperature, the condensation will disappear by itself.

CARE INSTRUCTIONS

As any soiling also represents a growth medium for microorganisms, you should take care to keep the equipment clean.

FOR THE CAMERA

- Only clean the Leica M with a soft, dry cloth. Stubborn dirt should first of all be covered with a well-thinned cleaning agent and then wiped off with a dry cloth.
- To remove stains and fingerprints, the camera and lens should be wiped with a clean lint-free cloth. Tougher dirt in hard to reach corners of the camera body can be removed with a small brush. The shutter blades may not be touched when doing this.
- All mechanically operated bearings and sliding surfaces on your Leica M are lubricated. Please remember this if you will not be using the camera for a long period of time. To prevent the lubrication points becoming gummed up, the camera shutter should be released a number of times every three months. It is also recommended that you repeatedly move and use all other controls. The range and aperture setting dials on the lens should also be moved periodically.
- Make sure that the sensor for 6-bit coding in the bayonet (see p. 147) is not soiled or scratched. Take care also that no grains of sand or similar particles enter the fastening, where they could scratch the bayonet. Only clean this component when dry and do not exert any pressure on the glass cover.

FOR LENSES

- Normally, a soft hair brush is sufficient to remove dust from the outer lens elements. However, in case of more stubborn dirt, they can be carefully cleaned with a very clean, soft cloth that is completely free of foreign matter, using circular motions from the inside to the outside. We recommend micro-fiber cloths (available from photographic and optical specialists) that are stored in a protective container and can be washed at temperatures of up to 40°C /104°F (without fabric softener, never iron!). Cloths for cleaning glasses, which are impregnated with chemicals, should not be used as they can damage the lens glass.
- Take care not to scratch the 6-bit coding (sj) in the bayonet fastening, or to get it dirty. Take care also that no grains of sand or similar particles enter the fastening, where they could scratch the bayonet. Never wet this component when cleaning it!
- For optimum front lens protection in unfavorable photographic conditions (e.g. sand, salt water spray), use transparent UVa filters. However, you should bear in mind that, like all filters, they can cause unwanted reflections in certain backlight situations and with high contrasts. The generally recommended lens hood also protects the lens from unintentional fingerprints and the rain.

FOR THE BATTERY

Rechargeable lithium ion batteries generate power through internal chemical reactions. These reactions are also influenced by the external temperature and humidity. Very high or low temperatures reduce the life of the battery.

- Always remove the battery if you will not be using the Leica M for a long period of time. Otherwise, after several weeks the battery could become totally discharged, i.e. the voltage is significantly reduced, as the Leica M uses a low no-load current even when it is turned off (e. g. for storing the date).
 - Lithium ion batteries should only be stored in a partially charged condition, i.e. not completely discharged or fully charged (in the corresponding display in the monitor). For very long storage periods, it should be charged up for around 15 minutes twice a year to prevent total discharge.
 - Always ensure that the battery contacts are clean and freely accessible. While lithium ion batteries are proof against short circuits, they should still be protected against contact with metal objects such as paper clips or jewelry. A short-circuited battery can get very hot and cause severe burns.
 - If a battery is dropped, check the casing and the contacts immediately for any damage. Using a damaged battery can damage the camera.
- In case of noise, discoloration, deformation, overheating or leaking fluid, the battery must be removed from the camera or charger immediately and replaced. Continued use of the battery results in a risk of overheating, leading to fire and/or explosion.
 - In case of leaking fluid or a smell of burning, keep the battery away from sources of heat. Leaked fluid can catch fire.
 - A safety valve in the battery guarantees that any excess pressure caused by improper handling is discharged safely.
 - Batteries have only a limited service life. We recommend replacing them after around four years.
 - Take damaged batteries to a collection point to ensure correct recycling.
 - The batteries may not be exposed to heat, sunlight, humidity or moisture for long periods. Likewise, the batteries may not be placed in a microwave oven or a high pressure container as this results in a risk of fire or explosion.

FOR THE CHARGER

- If the charger is used in the vicinity of radio receivers, it can interfere with the reception; make sure there is a distance of at least 1 m between the devices.
- When the charger is in use, it can make a noise (buzzing) – this is quite normal and is not a malfunction.
- When it is not in use, disconnect the charger from the mains as otherwise it uses a certain (very small) amount of power even when no battery is inserted in it.
- Always keep the charger contacts clean, and never short circuit them.
- The car charging cable supplied
 - may only be operated with 12V electrical systems,
 - may never be connected while the charger is connected to the mains.

FOR MEMORY CARDS

- While a picture is being stored or the memory card is being read, it may not be removed, nor may the Leica M be turned off or exposed to vibrations.
- For safety, memory cards should only ever be stored in the antistatic cover supplied.
- Do not store memory cards where they will be exposed to high temperatures, direct sunlight, magnetic fields or static discharge.
- Do not drop or bend a memory card as this can damage it and result in loss of the stored data.
- Always remove the memory card if you will not be using the Leica M for a long period of time.
- Do not touch the connections on the rear of the memory card and keep them free of dirt, dust and moisture.
- It is recommended that the memory card be reformatted from time to time, as fragmentation occurs when deleting, which can block some of the memory capacity.

Notes:

- Simple formatting does not cause the data on the card to be irretrievably lost. Only the directory is deleted, which means that the existing files are no longer directly accessible. The data can be accessed again using appropriate software. Only the data that is then overwritten by saving new data is actually permanently deleted. You should nevertheless get into the habit of transferring all your pictures onto a secure bulk storage medium, e.g. the hard drive on your computer, as soon as possible. This is particularly important if the camera is being sent for servicing along with the memory card.
- Depending on the memory card used, formatting can take up to 3 minutes.

CLEANING THE SENSOR / DUST DETECTION

If any dust or dirt particles should adhere to the sensor cover glass, depending on the size of the particles this can be identified by dark spots or marks on the pictures.

You can use the **Dust detection** function to check whether or how many particles are on the sensor. This is much more accurate than a visual inspection and is therefore a reliable method of assessing whether cleaning is required.

The Leica M can be sent to Leica Camera AG's Customer Care department for the sensor to be cleaned at a cost (address: see p. 254) – this cleaning is not included in the warranty.

You can also carry out cleaning yourself, using the **Sensor cleaning** function in the menu. This allows access to the sensor by keeping the shutter open.

DUST DETECTION

1. In the main menu (see p. 154/246) select **Sensor cleaning** (page 4 / **SETUP** section).
 - The relevant sub-menu appears.
2. Select **Dust detection**.
 - The message **Attention Please close the aperture to the largest value (16 or 22), and take a picture of a homogeneous surface (defocussed)**.
3. Press the shutter button (16).
 - After a short time, a "picture" appears in the monitor, in which black pixels represent grains of dust.

Note:

If dust detection is not possible, a corresponding message appears instead. After a few seconds, the display reverts to that described under 2. The picture can then be taken again.

CLEANING

1. In the main menu (see p. 154/246) select **Sensor cleaning** (page 4 / **SETUP** section).
 - The relevant sub-menu appears.
2. Select **Open shutter**.
3. Select **Yes**. If there is sufficient battery capacity, i.e. at least 60%, the shutter then opens.
 - The message **Please switch off camera after inspection** appears.

Note:

If the battery capacity is lower, the warning message **Attention Battery too low for sensor cleaning** appears instead to indicate that the function is not available, i.e. **Yes** cannot be selected.

4. Perform the cleaning. Make sure you follow the instructions below.
5. After cleaning, turning the camera off closes the shutter again.
 - The message **Attention Please stop sensor cleaning immediately** appears.

Notes:

- Generally: To protect the Leica M against ingress of dust etc. into the interior of the camera, it is important always to have a lens or a cover fitted to the camera body.
- For the same reason, when changing lenses work quickly and in an environment that is as dust-free as possible.
- As plastic parts can easily pick up a static charge and then attract more dust, the lens caps and covers should only be stored for short periods in pockets in clothing.
- As far as possible, both inspection and cleaning of the sensor should be performed in a dust-free environment to prevent further soiling.
- Lightly adhering dust can be blown off the sensor cover glass using clean and, if necessary ionized gases such as air or nitrogen. It makes sense to use a (rubber) bellows with no brush for this purpose. Special, low pressure cleaning sprays such as "Tetenal Antidust Professional" can also be used in line with their specified usage.
- If the particles cannot be removed from the sensor in this way, please refer the matter to your Leica Information Service.
- If the battery capacity falls to lower than 40% while the shutter is open, the warning message **Attention Please stop sensor cleaning immediately** appears in the monitor. At the same time a beep tone will sound, which continues until the camera is turned off. Turning the camera off will cause the shutter to be closed again.
- Be absolutely sure in this case that the shutter window is clear, i.e. that no object can obstruct the closing movement of the shutter, otherwise damage may occur.

Important:

- Leica Camera AG accepts no liability for damage caused by the user when cleaning the sensor.
- Do not attempt to blow dust particles off the sensor cover glass using your mouth; even tiny droplets of saliva can cause marks that are difficult to remove.
- Compressed air cleaners with high gas pressure may not be used as they can also cause damage.
- Take care to avoid touching the sensor surface with any hard objects during inspection and cleaning.

STORAGE

- If you are not using the Leica M for an extended period of time, we recommend that you:
 - a. Remove the memory card (see p. 146), and
 - b. Remove the battery (see p. 144), (the date and time entered will be lost after a maximum of 2 months).
- A lens works like a magnifying glass if bright sunlight shines on the front of the camera. The camera must always be protected from strong sunlight. Use the lens cover and keep the camera in the shade (or immediately put it away in the case) help to prevent damage to the interior of the camera.
- You should ideally store the Leica M in a closed and padded container so that nothing can damage it and it is protected from dust.
- Store the Leica M in a dry, adequately ventilated place, where neither high temperatures nor high humidity will occur. When used in humid conditions, the Leica M should be completely cleared of all moisture before being stored away.
- Photo cases that became wet during use should be emptied to prevent damage to your equipment caused by moisture and any leather-tanning residue released.
- To prevent fungal growth during use in hot, humid tropical climates, the camera equipment should be exposed to the sun and air as much as possible. Storage in airtight containers or cases is recommended only if a desiccant such as silica gel is placed in the container.
- To prevent the formation of fungus, do not store the Leica M in a leather case for extended periods of time.

- Note the serial numbers of your Leica M (engraved on the accessory shoe) and lenses, as these are extremely important in case of loss.

TROUBLESHOOTING

THE LEICA M DOES NOT RESPOND WHEN I TURN IT ON.

- Has the battery been correctly inserted?
- Does the battery have sufficient charge?
Use a charged battery.
- Has the bottom cover been correctly fitted?

THE LEICA M TURNS ITSELF OFF AGAIN AS SOON AS I TURN IT ON.

- Does the battery have sufficient charge to operate the Leica M?
Charge the battery or insert a charged battery.
- Is there any condensation?
This can occur if the Leica M is moved from a cold place to a warm place. In this case, wait until the condensation has evaporated.

THE LEICA M SHUTTER REFUSES TO TRIP.

- Picture data is currently being transferred to the memory card and the back-up memory is full.
- The capacity of the memory card is exhausted and the back-up memory is full.

Delete pictures you no longer require before taking new ones.

- No memory card has been inserted and the back-up memory is full.

I CANNOT SAVE THE PICTURE.

- Is a memory card inserted?
- The capacity of the memory card is full.

Delete pictures you no longer require before taking new ones.

THE MONITOR IS TOO DARK OR TOO BRIGHT.

- When viewing the monitor image from wide angles it is always more difficult to see.

If it is too light or too dark although you are looking at the monitor full on: Set a different brightness, or use the EVF2 external electronic viewfinder available as an accessory (see p. 224).

THE PICTURE I HAVE JUST TAKEN IS NOT SHOWN IN THE MONITOR

- Is the Auto Review function active (when the Leica M is set to picture mode)?

I CANNOT DISPLAY THE PICTURE.

- Is a memory card inserted?
- The memory card does not contain any data.

DESPITE BEING CONNECTED TO A COMPUTER (USING THE CONNECTED MULTIFUNCTION HAND GRIP), I CANNOT TRANSFER ANY DATA.

- Check whether the computer, multifunction hand grip and camera are connected correctly.

THE DATE AND TIME DISPLAYS SHOW INCORRECT VALUES OR ARE BLANK.

- The Leica M has not been used for a long period, particularly if the battery has been removed.





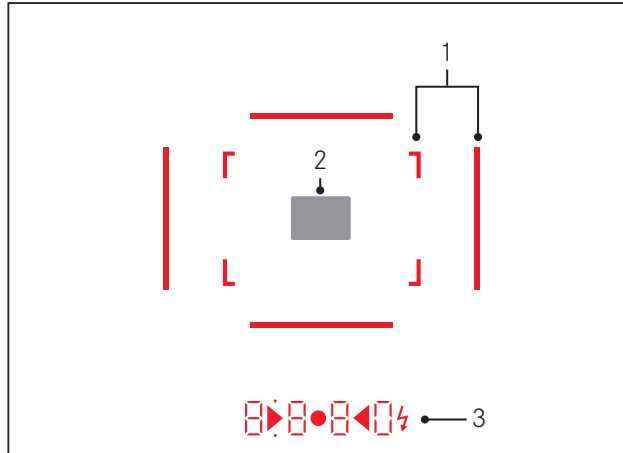

Insert a fully charged battery.

Set the date and time.

APPENDIX

DISPLAYS IN THE VIEWFINDER



1. Bright line frame for 50mm and 75mm (example)
2. Metering field for distance setting
3. LEDs (Light Emitting Diodes) for:
 - a. Four-digit digital display with dots above and below
 Digital display:
 - Display of the automatically determined shutter speed for aperture priority A, or for counting down shutter speeds slower than 1s
 - Warning that the metering or setting ranges are overshot or undershot using aperture priority A
 - Displays the exposure compensation value (briefly during adjustment)
 - Indicates that the back-up memory is (temporarily) full
 - Indicates that no memory card is loaded (Sd)
 - Indicates that the memory card is full (Full)
 - b.  Dot above:
 - Indication (when lit) that saved metering values are being used
 - c.  Dot below:
 - Indicates (flashing) that exposure compensation is being used
 - d.    Two triangular and one circular LED:
 - For manual exposure setting: Jointly used as light balance for exposure compensation. The triangular LEDs give the direction of rotation of the aperture setting ring and shutter speed setting dial to adjust the exposure.
 - Warning of values below the metering range
 - e.  Flash symbol:
 - Flash ready to use
 - Details of flash exposure before and after the picture

¹ With automatic brightness control adjusted to the ambient brightness. This automatic control is not available for Leica M lenses with viewfinder attachments, since they cover the brightness sensor 5 which supplies the information required for their operation. In such cases the frame and displays always maintain a constant brightness.

DISPLAYS IN THE MONITOR

WHEN TAKING A PICTURE

In live view mode



- 1 Exposure mode
- 2 Shutter speed
- 3 Exposure metering method
- 4 ISO sensitivity
- 5 Exposure lock
- 6 Exposure compensation

(additional for spot metering)

- 7 Metering field

(in addition to 1-7, for video recordings)

- 8 Elapsed recording time
- 9 Recording in progress indicator (flashing)

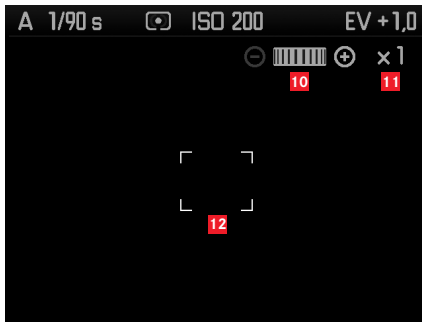

(in addition to 1-9, by focusing the lens or pressing the focus button (1.3); alternative to 13-17; not for video recordings)

- 10** Symbol for setting dial / available enlargement/reduction factors
- 11** Current zoom factor
- 12** Frame for trimming to be enlarged

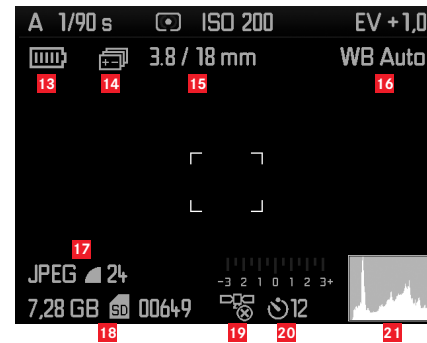

(in addition to 1-10, by pressing the INFO button (1.33); 13-15 alternative to 10-12)

- 13** Battery capacity
- 14** Bracketing
- 15** Light intensity / focal length or lens type
- 16** White balance
- 17** File format / compression / resolution or video format (depending on picture type)
- 18** Remaining memory capacity / number of pictures or time (depending on picture type)
- 19** GPS status (only with multifunction M hand grip attached)
- 20** Self-timer status / delay time
- 21** Picture histogram (not for video recordings)

In viewfinder mode, by pressing the INFO button

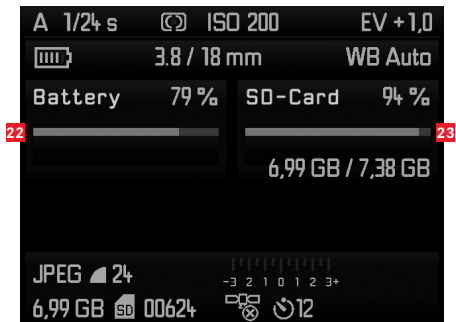

(in addition to 1-7/13-21)

22 Battery capacity

23 Memory card capacity

IN REVIEW MODE



- 24** Exposure mode
- 25** Shutter speed
- 26** Exposure metering method
- 27** Number of picture displayed / Total number of pictures on memory card
- 28** ISO sensitivity
- 29** Symbol for scroll / zoom function (only one)
- 30** Display of trimming size and position (trimming only)
- 31** Symbol for delete protected pictures
- 32** Symbol for video recording
- 33** Selected picture (reduced viewing of 4/9/36 pictures only)

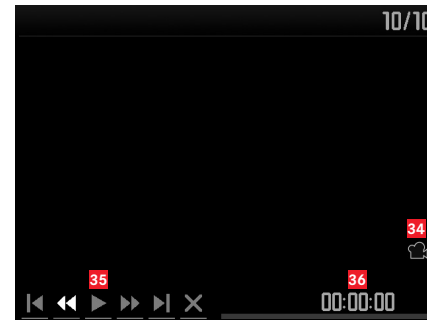

(in addition to 24-33, by pressing the INFO button (1.33) for a video recording)

- 34** Symbol for video playback
- 35** Video control symbols
- 36** Elapsed playback time / progress bar

With histogram

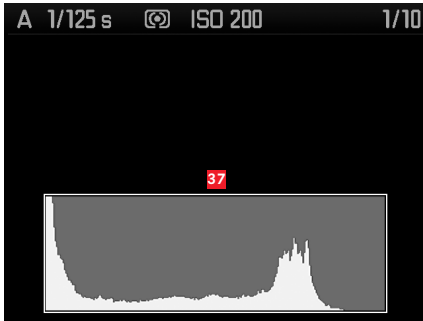

(as for 24-36, additional)

37 Histogram (standard or RGB, selectable using menu control)

With clipping displays



(as for 24-36, picture areas without marking flash red/blue, additional)

38 Clipping symbol

With additional information



(in addition to 28-37, by pressing the **INFO** button (1.33), reduced picture)

- 39** User profile number / name
- 40** Color space
- 41** Date
- 42** Time
- 43** Folder number / file name
- 44** File format / compression / resolution or video format (depending on picture type)
- 45** Exposure compensation
- 46** White balance
- 47** Light intensity / focal length
- 48** Symbol for video recording
- 49** Symbol for delete protected pictures (only appears if pictures are selected)
- 50** GPS status
- 51** Symbol for flash picture (not for video recordings)

For menu control

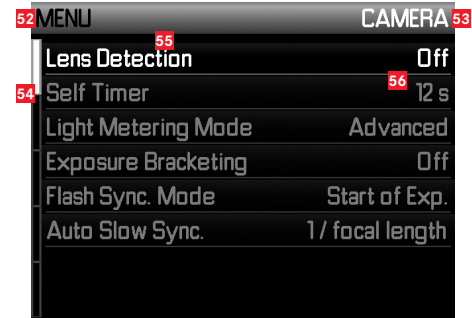

- 52** Specification of menu, **MENU** = main menu / **SET** = picture parameters menu
- 53** Specification of menu section (main menu only)
- 54** Scroll bar with page indication (main menu only)
- 55** Menu option
- 56** Menu option setting

MENU OPTIONS

MAIN MENU (MENU button)

CAMERA (page 1)

Lens Detection	see p. 162
Selftimer	see p. 198
Light Metering Mode	see p. 180
Exposure Bracketing	see p. 186
Flash Synch. Mode	see p. 195
Auto Slow Sync.	see p. 194

Section IMAGE (page 2)

Sharpness	see p. 169
Saturation	see p. 169
Contrast	see p. 169
Film mode	see p. 169
Color space	see p. 170
DNG Compression	see p. 163

Section SETUP (page 3)

Monitor Brightness	see p. 173
EVF Brightness	see p. 173
Frameline Color	see p. 171
Focus Peaking	see p. 177
Focus Aid	see p. 177
Histogram	see p. 208
Clipping Definition	see p. 209
Auto Review	see p. 204

Section SETUP (page 4)

Copyright information	see p. 199
Image numbering	see p. 217
Horizon	see p. 201
Sensor cleaning	see p. 233
GPS	see p. 199
Audio	see p. 197

Section SETUP (page 5)

Auto Power Off	see p. 160
Date / Time	see p. 158
Acoustic Signal	see p. 161
Language	see p. 158
USB Mode	see p. 219
Reset	see p. 203
Format SD card	see p. 218
Firmware	see p. 223

PICTURE PARAMETERS MENU (SET button)

ISO	see p. 167
White Balance	see p. 165
File Format	see p. 163
JPEG Resolution	see p. 164
Video Resolution	see p. 196
Exposure Compensation	see p. 184
Exposure Metering	see p. 179
User Profile	see p. 201

INDEX

Aperture priority	166	Metering range	189/250
Aperture setting ring	120	Sensitivity	173
Battery, inserting and removing	144	Turning off	163
Bright-line view and range finder	171	Turning on	163
Care instructions	230	Values above and below the metering range	189
Carrying strap	140	Film styles	170
Cases	227	Filters	224
Color saturation, see Picture properties		Firmware downloads	223
Compression rate	143	Flash mode	190
Contrast, see Picture properties		Flash units	190
Copyright	199	Synchronization	194
Corrective lenses	227	Formatting the memory card	218
Customer Care	254	GPS	199
Data structure on the memory card	221	Histogram	208/241
Date and time	158	Horizon	201
Deleting pictures	212	HSS flash	194
Depth of field scale	136	Image frequency	152
Designation of parts	136	Info Service, Leica	254
Displays		Interchangeable lenses	147/224
In the monitor	240	ISO sensitivity	167
In the viewfinder	238	Lenses, Leica M	247
DNG	163/222	Attaching and removing	249
Electronic viewfinder	224	Design	136
Enlarging pictures	211	Use of older lenses	247
Exposure / Exposure control / Exposure meter		Linear flash (HSS)	194
Aperture priority	182	Live view	174/177
Exposure compensation	184	M hand grip	226
Manual setting	188	Main switch	150
Metering methods	180	Memory card, inserting and removing	145
		Menu control	154
		Menu language	158

Menu options.....	246	Sharpness, see Picture properties	
Microphone adapter M.....	227	Shutter, see Shutter release and Technical data	
Monitor.....	173	Shutter release, see also Shutter and Technical data	151 / 252
Multifunction M hand grip	226	Shutter speed dial.....	153
Package contents.....	253	Sound recording	197
Parts, Designation.....	136	Sounds (acknowledge (response) tones).....	161
Picture properties (contrast, sharpness, color saturation)	169	Spare parts.....	227
Picture series.....	152	Speed/aperture combination, see Exposure setting	188
Power off, automatic	160	Spirit level.....	191
Protecting pictures / Clearing delete protection	214	Storage.....	236
R Adapter-M.....	224	Technical data.....	250
Range setting.....	175	Trimming, selection, see Review mode.....	204 / 211
Focusing assistances.....	177 / 178	Transferring data to a computer.....	219
In the monitor.....	157	Turning on/off	150
Metering field	171 / 238	Troubleshooting	236
Range finder.....	171	Video recordings.....	196
Setting ring	136	Viewfinder.....	171
Split image method.....	176	Attachable viewfinder	224 / 225
Superimposed image method	176	Bright-line frames	171 / 228
Raw data.....	163 / 222	Displays	238
Repairs / Leica Customer Care	254	Viewing the picture	204
Resetting all custom menu settings	203	with the Auto Review function (automatic review)	205
Resolution.....	164	with the PLAY function	204
Review mode	204	Volume	161
Safety instructions	228	Warning messages	134
SCA adapter set.....	226	White balance	165
Self-timer.....	198		
Sensitivity	157 / 189		

TECHNICAL DATA

Camera type

Leica M (Typ 240), compact digital view and range finder system camera.

Lens connection

Leica M bayonet with additional sensor for 6-bit coding.

Lens system

Leica M lenses from 16 - 135mm.

Picture format / Image sensor

CMOS chip, active area approx. 23.9 x 35.8mm (corresponds to usable format of analog Leica M models).

Resolution

DNG™: 5976 x 3992 pixels (24MP),

JPEG: 5952 x 3968 pixels (24MP), 4256 x 2832 pixels (12MP), 2976 x 1984 pixels (6MP), 1600 x 1072 pixels (1.7MP);

For video recordings: 640 x 480 pixels (VGA), 720P, 1080P.

Data formats

DNG™ (raw data), either uncompressed or compressed (loss free), 2 JPEG compression levels.

File size

DNG™: Compressed 20-30 MB, uncompressed 48.2 MB,

JPEG: Depending on resolution and picture content.

Video recording formats

Motion JPG, Quicktime

Video frame rates

24 fps, 25 fps, 30 fps (with VGA resolution only)

Color spaces

Adobe® RGB, sRGB.

Sound recording

Mono, Stereo using microphone adapter (see p. 227), choice of automatic or manual modulation during recording or fixed "Concert" setting,

White balance

Automatic, manual, 7 presets, color temperature entry.

Storage medium SD cards up to 2 GB / SDHC cards up to 32 GB / SDXC cards.

Menu languages

German, English, French, Spanish, Italian, Japanese, Traditional Chinese, Simplified Chinese, Russian

Compatibility

Windows® Vista® SP2 / 7® SP1; Mac® OS X (10.6.8 or higher)

Exposure metering

Exposure metering through the lens (TTL), with working aperture.

Center-weighted TTL metering for flash lighting with system-compatible SCA-3000/2 standard flash units.

Metering principle / method

For metering the light reflected by light blades of the 1st shutter curtain onto a measuring cell: Strong center-weighted; For metering on the sensor: Spot, center-weighted, multi-field metering.

Metering range

(with ISO 200/24) At room temperature and normal humidity, corresponds to ISO 200 at aperture 1.0 EVO to EV20 at aperture 32. Flashing of the left triangular LED in the viewfinder indicates values below the metering range.

Sensitivity range

Adjustable from ISO 200/21 to ISO 6400/39, in 1/3 ISO increments, choice of automatic control or manual setting, Pull 100.

Exposure mode

Choice of automatic shutter speed control with manual aperture preselection – aperture priority **A**, or manual shutter speed and aperture setting.

Flash exposure control

Flash unit attachment

Using accessory shoe with center and control contacts or using SCA adapter set (see p. 226).

Synchronization

Optionally triggered at the 1st or 2nd shutter curtain.

Flash sync speed

↔ = 1/180S; slower shutter speeds can be used, if working below sync speed: Automatic switching to TL linear flash mode with HSS compatible Leica system flash units.

Flash exposure metering

(with SCA-3502-M5 adapter or SCA-3000 standard flash unit, e.g. Leica SF 26 / Leica SF 58) Control with center-weighted TTL pre-flash metering.

Flash measurement cell

2 silicon photo diodes with collection lens on the camera base.

Flash exposure compensation

±3 1/3 EV in 1/3 EV increments adjustable on SCA-3502 adapter. On Leica SF 26 ±3EV in 1/3 EV increments or from 0 to –3EV in 1EV increments adjustable with computer control / on Leica SF 58 ±3EV in 1/3 EV increments in all modes.

Displays in flash mode (in viewfinder only)

Ready: Constant illumination of flash symbol LED in viewfinder.

Confirmation: Continued illumination or brief rapid flashing of LED after exposure.

Underexposure indicator: LED temporarily goes out.

Viewfinder

Viewfinder principle

Large, bright line frame viewfinder with automatic parallax compensation.

Eyepiece

Adjusted to –0.5 dptr. Corrective lenses from –3 to +3 dpt. available.

Image field limiter

By activating two bright lines each: For 35 and 135mm, or for 28 and 90mm, or for 50 and 75mm. Automatic activation when lens is attached. Frame color (red/white) selectable in menu.

Parallax compensation

The horizontal and vertical difference between the viewfinder and the lens is automatically compensated according to the relevant distance setting, i.e. the viewfinder bright-line automatically aligns with the subject detail recorded by the lens.

Matching viewfinder and actual image

At a range setting of 2 meters, the bright-line frame size corresponds exactly to the sensor size of approx. 23.9 x 35.8mm. At infinity setting, depending on the focal length, approx. 7.3% (28mm) to 18% (135mm) more is recorded by the sensor than indicated by the corresponding bright line frame and slightly less for shorter distance settings than 2m.

Magnification (For all lenses)
0.68x

Large-basis rangefinder

Split or superimposed image range finder shown as a bright field in the center of the viewfinder image.

Effective metering basis

47.1mm (mechanical measurement basis 69.25mm x viewfinder magnification 0.68x).

Displays

In the viewfinder

Four-digit digital display with dots above and below, displays, see p. 238.

On back

3" color TFT LCD monitor with 16 million colors and 921,600 pixels, approx. 100% image field, max. 170° viewing angle, anti-reflection/ dust protective glass (Gorilla Glass®), color space: sRGB, for live view and review mode, displays see p. 240.

Shutter and shutter release

Shutter

Metal blade focal plane shutter with vertical movement.

Shutter speeds

For aperture priority: **(A)** continuous from 60s to $1/4000$ s.

For manual adjustment: 8s to $1/4000$ s in half steps,

B: For long exposures up to maximum 60s (in conjunction with self-timer T function, i.e. 1st release = shutter opens, 2nd release = shutter closes).

⚡ ($1/180$ S): Fastest shutter speed for flash synchronization, HSS linear flash mode possible with all shutter speeds faster than $1/180$ s (with HSS compatible Leica system flash units).

For video recordings (aperture priority and manual mode): $1/30$ to $1/4000$ s, for manual mode possible override of specified shutter speed to ensure correct exposure.

Cocking the shutter

By integrated motor, low noise operation.

Picture series

Approx.: 3 frames/s, ≤12 pictures in series.

Shutter release

For single pictures: Two-stage, 1. Activation of exposure metering and exposure lock (in aperture priority mode), 2. Shutter release. Standard thread for cable release integrated.

Self-timer

Delay optionally 2 (aperture priority and manual exposure setting) or 12s, set in menu, indicated by flashing LED on front of camera and corresponding display in monitor.

Turning the camera on/off

Using main switch on top of camera; optional automatic shutdown of camera electronics after approx. 2/5/10 minutes; reactivated by tapping the shutter release.

Power supply

1 lithium ion battery, nominal voltage 7.4V, capacity 1800mAh. Capacity display in monitor; with shutter held open (for sensor cleaning) additional acoustic warning of low capacity, maximum charging current/voltage: DC, 1100mA/ 8,25V.

Charger

Inputs: 100-240V AC, 50/60Hz, automatic switching, or 12V DC, 1.3A;
Output: DC, maximum 8.25V, 1100mA.

GPS

Optional (with multifunction hand grip attached (see p. 226), not available everywhere due to country-specific legislation, i.e. enforced automatic shutdown in those countries), data written to EXIF header in picture files.

Virtual horizon

Measurement by 3-level acceleration sensor, measuring range: inclination (about transverse axis) and tilt (about longitudinal axis) each $\pm 90^\circ$, measuring accuracy / display sensitivity: $\leq 1^\circ$ at 0-40°C/ 32-104°F and horizontal alignment, display in monitor

Camera body

Material

All-metal die cast magnesium body, synthetic leather covering. Brass top panel and base, black or steel gray lacquered finish.

Tripod thread

A ¼ (¼") DIN stainless steel in bottom cover.

Operating conditions

0-40°C / 32-104°F

Interfaces

ISO flash shoe, accessory socket, contact strip for multifunction M hand grip.

Dimensions

(Width x Depth x Height) Approx. 138.6 x 42 x 80mm

Weight

Approx.: 680g (with battery)

Package contents

Charger 100-240V with 2 mains cables (Euro, USA, varies in some export markets) and 1 car charging cable, lithium ion battery, carrying strap, body bayonet cover, Adobe® Photoshop® Lightroom® license.

Subject to changes to design, manufacture and range.

LEICA INFORMATION SERVICE

The Leica Information Service can provide you with an answer to any technical questions relating to Leica products, including software supplied, either in writing, on the telephone or by e-mail. They are also the contact point for purchasing advice and to order instructions. Alternatively, you can send us your questions using the contact form on the Leica Camera AG homepage.

Leica Camera AG
Product Support / Software support
Am Leitz-Park 5
D-35578 Wetzlar
Telefon: +49(0)6441-2080-111
Telefax: +49(0)6441-2080-339
info@leica-camera.com /
software-support@leica-camera.com

LEICA CUSTOMER SERVICE

For servicing your Leica equipment or in the event of damage, the Leica Camera AG Customer Care department or the repair service provided by authorized Leica agents in your country are available.

Leica Camera AG
Customer Care
Am Leitz-Park 5
D-35578 Wetzlar
Telefon: +49(0)6441-2080-189
Telefax: +49(0)6441-2080-339
customer.care@leica-camera.com

You will find your local contact partner on the service page:
http://uk.leica-camera.com/service/service_and_repair/worldwide_network

