



LEICA M11

QUICK START GUIDE



Download the full scope instruction manual here:

en.leica-camera.com/Service-Support/Support/Downloads

Please register via the following link if you would like to receive a printed copy of the full scope instruction manual:

www.order-instructions.leica-camera.com

PART DESIGNATIONS

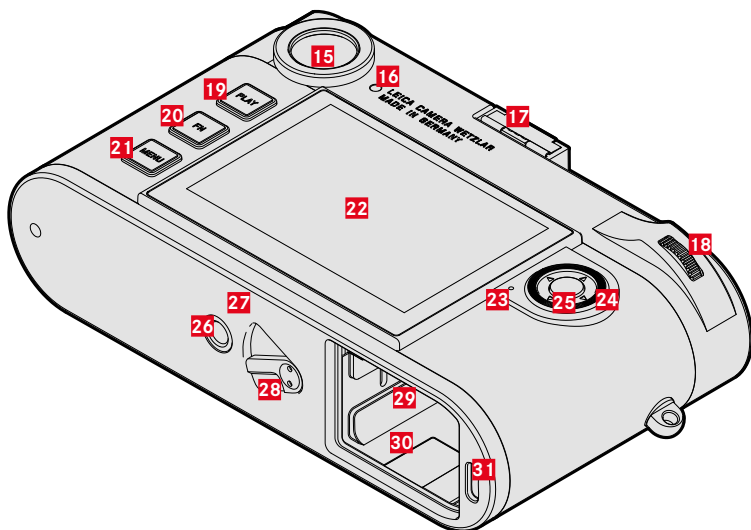
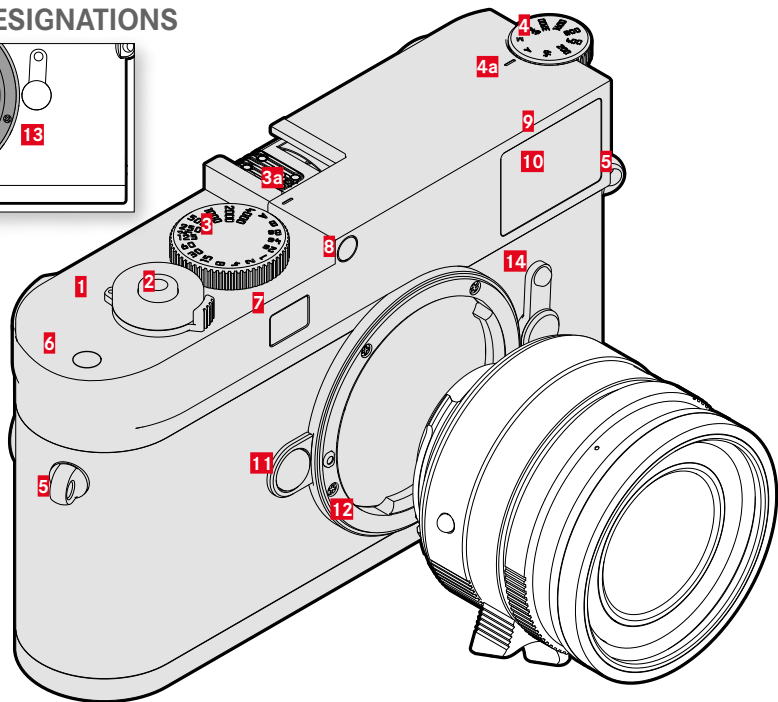
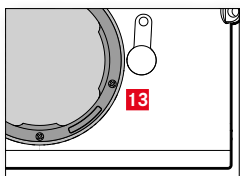

1 Main switch
Switching the camera ON/OFF

2 Shutter button

Tap:

- Activating exposure metering and exposure control

Press down fully:

- Shutter release

in standby mode:

- The camera is reactivated

3 Shutter speed setting dial with stop positions

- **A:** Automatic shutter speed control
- **Bs - 4000:** Shutter speeds (inc. intermediate values)
- **B:** Long-term exposure (1/16000s - 60 min, via menu control, in full increments or Bulb)
- **⚡:** Flash sync speed (1/180s)

a Index

4 ISO dial

- **A:** Automatic ISO sensitivity control
- **64 - 6400:** fixed ISO values
- **M:** Setting in the menu or status screen

a Index

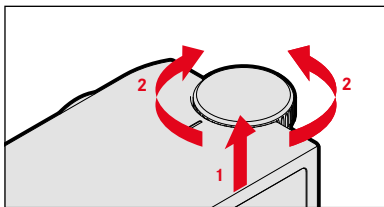

5 Strap lugs

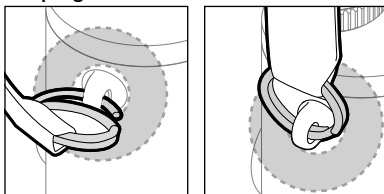

6 Function button**

7 Rangefinder window

8 Brightness sensor

9 Self-timer LED

10 Viewfinder window

11 Lens release button

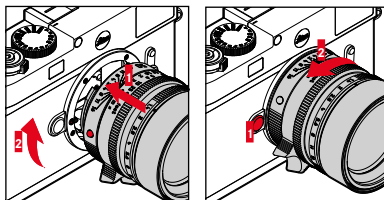

12 Bayonet

13 6-bit encoding

Sensor for lens detection

14 Image field selector

Selection of bright-line frame pairs 35/135 mm, 50/75 mm and 28/90 mm

15 Viewfinder eyepiece

16 Brightness sensor for LCD panel

17 Accessory shoe

18 Thumbwheel

in the menu:

- Menu navigation
- Setting selected menu items/functions

in shooting mode:

- Exposure compensation value selection

in review mode:

- Enlarging/reducing viewed pictures

Press:

- Use as function button**

19 PLAY button

- Switchover between shooting and review/playback mode
- Return to full-screen display

20 FN button**

21 MENU button

in the menu:

- Access to status screen and the menus [Favorites/Main Menu](#)
- Exiting the currently displayed (sub) menu

22 LCD panel

23 Status LED

24 Directional pad

in the menu:

- Menu navigation
- Setting selected menu items/functions

in review mode:

- Scroll through the gallery

**Press & release: Access to the assigned function. Press & hold: Modify assignment (drop-down list).

25 Center button

in the menu:

- Applying menu settings

in shooting / playback mode:

- Accessing the information displays

26 Tripod thread

A ¼, DIN 4503 (¼")

27 LED

28 Battery release lever

29 Memory card slot

- ▶ Ensure that the camera is switched OFF
- ▶ Removing the battery

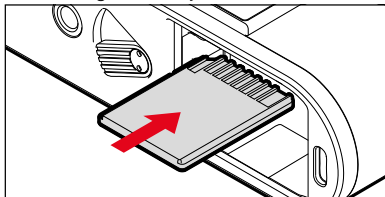

30 Battery compartment

31 USB-C socket

CHARGING THE BATTERY

The camera is powered by a lithium-ion battery.

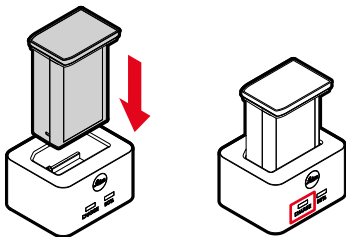

The status LED indicates a correct charging process.

PREPARING THE CHARGER

- ▶ Use the plug with the matching regional plug to connect the charger to mains electricity
 - The charger will automatically adapt to local mains voltage.

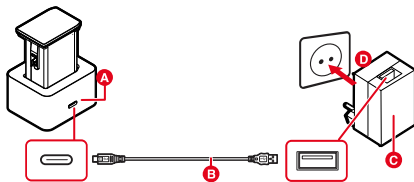

CHANGING THE BATTERY

- ▶ Ensure that the camera is switched OFF

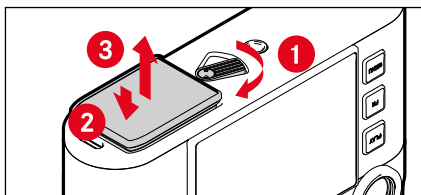

LIVE VIEW

- ▶ Press the FN button
 - Only if the function **Live View** is assigned to the FN button (factory setting).

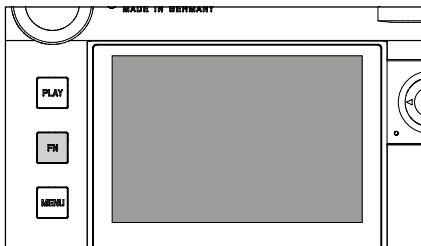

DISPLAYS ON THE LCD PANEL

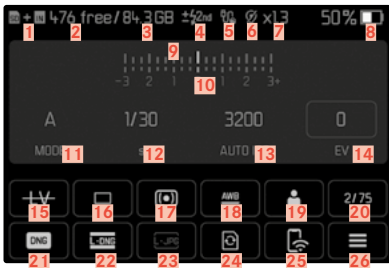

- 1 Storage location
- 2 Remaining number of recordings
- 3 Remaining storage capacity
- 4 Flash sync point
- 5 Leica app connection
- 6 GPS function via Leica FOTOS app

- 7 Digital zoom
- 8 Battery capacity
- 9 Light balance
- 10 Exposure compensation scale
- 11 Exposure mode
- 12 Shutter speed
- 13 ISO Sensitivity
- 14 Exposure compensation value
- 15 Live View On/Off
- 16 Shooting mode (Drive Mode)
- 17 Exposure metering method
- 18 White balance mode
- 19 User profile
- 20 Light intensity/focal length or lens type
- 21 File format
- 22 DNG Resolution
- 23 JPG resolution
- 24 Formatting a memory card
- 25 Leica FOTOS
- 26 Main menu

DISPLAYS IN THE VIEWFINDER

The bright-line rangefinder in this camera is more than just a very bright viewfinder – it also is a lens-coupled rangefinder. All Leica M lenses with focal lengths between 16 and 135 mm are coupled automatically.

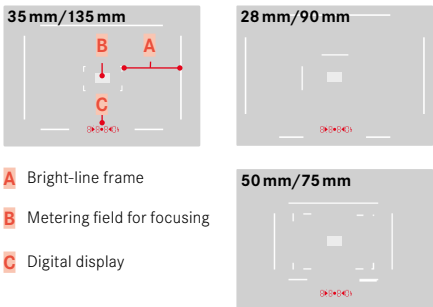

- A Bright-line frame
- B Metering field for focusing
- C Digital display

LEICA FOTOS APP

Experience the new Leica FOTOS app. The Leica FOTOS app is a digital tool with plenty of exciting options and allows the photographer to get more out of his Leica camera than ever before. You can now link all your WLAN-capable Leica cameras via a single app to transfer images easily and instantly, capture the essence of unforgettable moments, manage, optimize and share your photos – anytime, anywhere.



INITIAL START/APP CONNECTION

VIA CABLE

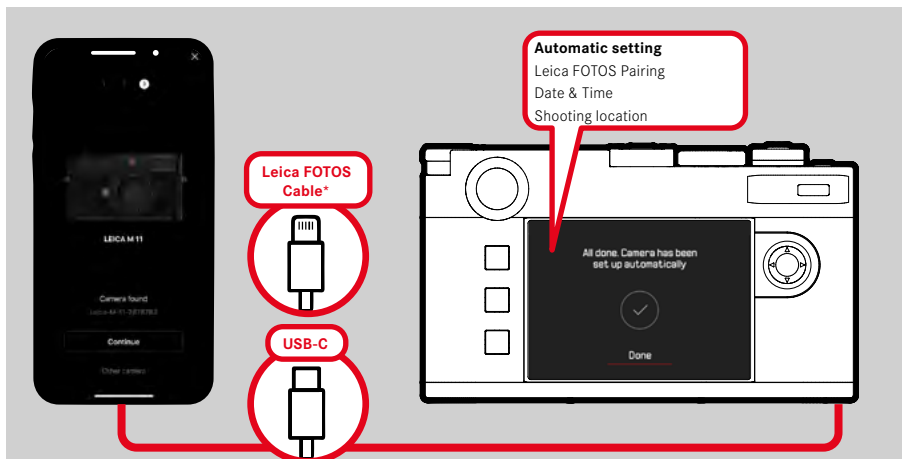

*Note

The Leica FOTOS cable allows direct data exchange between the Leica FOTOS app and the camera. It cannot be used for the charging of Apple® devices.

FOCUSING

SUPERIMPOSED IMAGE METHOD (DOUBLE IMAGE)

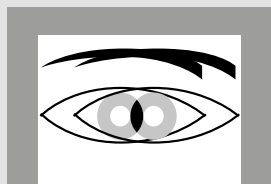

X

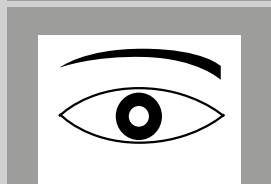

✓

SPLIT IMAGE METHOD

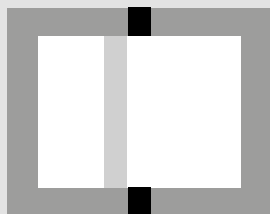

X

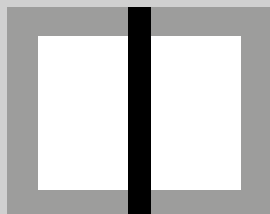

✓

FN BUTTON ASSIGNMENTS

- Press & release: Call-up of assigned function.
- Press & hold: Modify assignment (drop-down list).

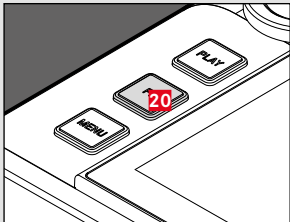
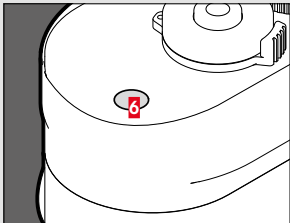
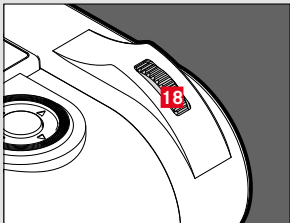
FN button	Factory settings	Available
	<p>Live View</p> <p>Activating/deactivating the Live View mode</p>	<p>Lens Detection</p> <p>Drive Mode</p> <p>Self Timer</p> <p>Interval Shooting</p> <p>Exposure Bracketing</p> <p>Capture Assistants</p> <p>Exposure Metering</p> <p>M-ISO</p>
	<p>Focus Aid</p>	<p>Auto ISO Settings</p> <p>Maximum ISO</p> <p>Shutter Speed Limit</p> <p>White Balance</p> <p>Gray card</p> <p>File Format</p> <p>DNG Resolution</p> <p>Max. JPG Resolution</p>
	<p>Exposure Compensation</p>	<p>Digital Zoom</p> <p>Film Style</p> <p>Shutter Type</p> <p>Flash Settings</p> <p>Flash Exp. Compensation</p> <p>User Profile</p> <p>EVF LCD</p> <p>Format SD Card</p> <p>Leica FOTOS</p>

TOUCH CONTROL



“tap”



“double tap”



“horizontal swipe”
“vertical swipe”



“two-finger pinch”



“two-finger spread”

TECHNICAL DATA

CAMERA

Designation

Leica M11

Camera type

Digital system camera with rangefinder

Type no.

2416

Order No.

	Regional Variant		
	EU/US/CN	JP	ROW
Order No. (Color)	20200 (black)	20202 (black)	20206 (black)
	20201 (silver)	20203 (silver)	20207 (silver)
Wi-Fi 5GHz	11a/n/ac: channel 149-165 (5745-5825MHz)	11a/n/ac: channel 36-48 (5180-5240MHz)	-
Wi-Fi 2.4GHz	11b/g/n: channel 1-11 (2412-2462MHz)		
Bluetooth	4.2 BR/EDR/LE: BR/DR channel 1-79 LE channel 0-39 (2402-2480MHz)		

Storage medium

SD cards 1-2 GB / SDHC cards up to 32 GB / SDXC cards up to 2 TB, internal memory 64 GB

Material

Top/bottom cover:

Silver: chromed brass, **Black:** coated aluminum

Front and rear housing panels: magnesium

Lens mount

Leica M bayonet

Interfaces

ISO accessory shoe with additional control contacts for Leica flash units and Leica Visoflex2 viewfinder (optional accessory)

USB-C cable for data transfer and battery charging

Compatible lenses

Leica M-lenses, Leica R-lenses via adapter

Operating conditions

0/+40°C

Rated input voltage / current

DC 7.4V, 1.5A (continuous)

Dimensions (WxHxD)

139 x 38.5 x 80 mm

Weight

Silver: approx. 640 g (with battery)

Black: approx. 530 g (with battery)

SENSOR

Sensor size

CMOS chip, active surface approx. 24x36 mm

Image resolution

DNG™	L-DNG	60.3 MP	9528 x 6328 pixels
	M-DNG	36.5 MP	7416 x 4928 pixels
	S-DNG	18.4 MP	5272 x 3498 pixels
JPG	L-JPG	60.1 MP	9504 x 6320 pixels
	M-JPG	36.2 MP	7392 x 4896 pixels
	S-JPG	18.2 MP	5248 x 3472 pixels

LCD PANEL

LCD panel

2.95" TFT LCD, 1080x720 pixels

EQUIPMENT

WLAN/Bluetooth

The Leica FOTOS app is required to use the WLAN function. The Leica app is available from the Apple App Store™ or the Google Play Store™. 2.4 GHz/5 GHz* dual band IEEE802.11 a/b/g/n/ac Wave2 WLAN (standard WLAN protocol), encryption method: WLAN-kompatible WPA™/WPA2™, access method: infrastructure mode

POWER SUPPLY

Charger (Leica BC-SCL7)

Input: USB-C DC 5V, 2A, output: DC 8.4V, 1A, operating conditions: +10°C to +35°C, manufacturer: Dee Van Enterprises Co., Ltd., made in China

AC-Adapter (Leica ACA-SCL7)

Input: AC 100V - 240V ~ 50/60Hz, 0.3A, output: DC 5V, 2A, operating conditions: +10°C to +35°C, manufacturer: Dee Van Enterprises Co., Ltd., made in China

Rechargeable battery (Leica BP-SCL7)

Li-Ion (Lithium-Polymer) rechargeable battery, rated voltage: 7.4V / capacity: 1800mAh, Charging voltage / current: DC 7.4V, 1000mA, operating conditions: +10°C to +35°C (charging) / +0°C to +40°C (discharging), manufacturer: Fuji Electronics (Shenzhen) Co., Ltd. made in China

* Unavailable for regional variant "ROW".

The production date of your camera is printed on the packaging.

The date format is year/month/day. Subject to changes in design and model type.

SAFETY REMARKS

GENERAL INFORMATION

- Do not use your camera in the immediate vicinity of devices that generate powerful magnetic, electrostatic or electromagnetic fields (e.g. induction ovens, microwave ovens, television sets or computer screens, video game consoles, cell phones, broadcasting equipment). Their electromagnetic fields can interfere with recordings.
- Strong magnetic fields, e.g. from speakers or large electric motors can damage the stored data or disrupt shooting.
- Switch off the camera, remove the battery briefly, replace it and switch the camera back on in case of a camera malfunction due to the effects of electromagnetic fields.
- Do not use the camera in the immediate vicinity of radio transmitters or high-voltage power lines. Their electromagnetic fields may interfere with recordings.
- Always store small parts e.g. the accessory shoe cover as follows:
 - out of the reach of children
 - in a safe location, where they will not get lost or stolen
- State-of-the-art electronic components are sensitive to static discharge. You can easily pick up charges of several 10,000 volts by simply walking on synthetic floor coverings. A static discharge can occur when you touch the camera and especially if it is placed on a conductive surface. A static discharge on the camera housing poses no risk for the electronics. Despite built-in safety circuits, you should avoid direct contact with external camera contacts like those in the flash shoe.
- Take care not to soil or scratch the sensor for lens detection in the bayonet. You must similarly prevent direct contact of the bayonet with grains of sand or similar particles, as these could cause irreparable damage. This component must only be cleaned with a dry cloth (in system cameras).
- Use a cotton or linen cloth instead of a microfiber cloth from an optician's (synthetic) when cleaning the contacts. Make sure to discharge any electrostatic charge by deliberately touching a heating or water pipe (conductive, grounded material). Dirt deposits and oxidation on the contacts can be avoided by storing your camera in a dry location with the lens cap and the flash shoe/viewfinder cap (in system cameras) attached.
- Only use accessories specified for this model to prevent faults, short circuits or electric shock.
- Do not attempt to remove parts of the housing (covers) yourself. Repairs must be done at authorized service centers only.
- Protect the camera against contact with insect sprays and other aggressive chemicals. Petroleum spirit, thinner and alcohol must not be used for cleaning. Some chemicals and liquids can damage the camera housing or the surface finish.
- Rubber and plastics are known to expel aggressive chemicals and should therefore not be kept in contact with the camera for extended periods of time.
- Prevent any sand or dust or water penetration into the camera, e.g. during snowfall or rain or on the beach. Be extra careful when changing the lens (in system cameras) and when inserting or removing the memory card and rechargeable battery. Sand and dust can damage the camera, the lens, the memory card and the battery. Moisture can cause malfunctions and irreparable damage to the camera and memory card.

LENS

- A camera lens can have the effect of a magnifying glass when exposed to direct frontal sunlight. The camera must therefore be protected against extended exposure to direct sunlight.
- Attaching the lens cap and keeping the camera in the shade or ideally in its camera case, will help prevent damage to the interior of the camera.

BATTERY/CHARGER

- Use of the rechargeable battery type (BP-SCL7) named and described in this manual is mandatory.
- Improper use of the batteries or the use of unapproved battery types may result in an explosion!
- Do not expose the rechargeable battery to sunlight, heat, humidity or moisture for prolonged periods of time. Likewise, the batteries must not be placed in a microwave oven or a high-pressure container as this would pose a fire or explosion hazard!
- Do not under any circumstances charge or insert a damp or wet battery into the camera!
- Keep the battery contacts clean and easily accessible. Although lithium-ion batteries are secured against short circuits, they should still be protected against contact with metal objects like paper clips or jewelry. A short-circuited battery can get very hot and cause severe burns.
- When a battery is accidentally dropped, make sure to check the housing and the contacts immediately for any damage. A damaged battery can damage the camera.
- The battery must be removed from the camera or charger and must be replaced immediately in case of a strange smell, discoloration, deformation, overheating or leakage. Continued use of the battery may result in overheating, which can cause fire and/or explosion!
- Never throw batteries into a fire as they may explode.
- Keep the battery away from sources of heat in case of leakage or if you smell burning. Leaked fluid can catch fire!
- Use of the charger (BC-SCL7) named and described in this manual in combination with the stated AC-Adapter (ACA-SCL7) and its interchangeable AC-Plugs is mandatory.
- The use of other chargers not approved by Leica Camera AG can cause damage to the batteries – and in extreme cases – cause serious or life-threatening injuries.
- Make sure that the power socket is freely accessible at all times.
- Do not attempt to open the battery or the charger. Repairs must only be carried out by authorized service centers.
- Keep batteries out of the reach of children. Batteries can cause suffocation when swallowed.
- Always keep the charger contacts clean, and never short-circuit them.

- Using the charger in the vicinity of broadcasting receivers may interfere with reception. Ensure a distance of at least 1 m between the charger and the receiver.
- When the charger is in use, it may emit a buzzing sound – that is normal and not a malfunction.
- Disconnect the charger from the mains when it is not in use, as it consumes electricity (a very small amount), even if no battery is inserted.
- The battery must have a temperature between +10°C and +35°C for charging (otherwise the charger will not switch on or will switch off again immediately).
- Lithium-ion batteries can be charged at any time, regardless of their current charge level. A partially charged battery will charge to full capacity faster than a fully discharged one.
- The rechargeable batteries come only partly charged ex works and should therefore be charged fully before their first use.
- A new battery only reaches its full capacity after it has been fully charged and – by using it in the camera – depleted 2 to 3 times. This depletion process should be repeated roughly every 25 cycles.
- Battery and charger heat up during the charging process. That is normal and not a malfunction.
- A flashing charge status indicator when charging commences indicates a fault (e.g. max. charging time is surpassed, voltage or temperature outside permitted parameters or a short-circuit). Disconnect the charger from the mains and remove the battery. Ensure that the above temperature conditions are met and then restart the charging process. Please contact your dealer, the Leica representative in your region or Leica Camera AG if the problem persists.
- Rechargeable lithium-ion batteries generate power by way of internal chemical reactions. These reactions are influenced by ambient temperature and humidity. Do not expose the battery to extreme temperatures (high or low) for extended periods of time (e.g. in a parked car in the summer or winter) to ensure a maximum service life.

FIRST AID

- Battery fluid may cause blindness if it comes into contact with the eyes. Rinse the eyes thoroughly with clean water immediately. Avoid rubbing. Seek medical attention immediately.
- Leaked battery fluid poses an injury hazard when it comes in contact with clothing or skin. Rinse the affected areas thoroughly with clean water.

MEMORY CARD

- Never remove the memory card during a datasave or card reading process. The camera must not be switched off or be subjected to impact or vibrations while working.
- Do not drop or bend memory cards as this will cause damage and result in the loss of stored data.
- Do not touch the connections on the reverse of the memory card and keep them clean and dry.
- Keep memory cards out of the reach of children. Swallowing a memory card may cause suffocation.

SENSOR

- Cosmic radiation (e.g. during flights) may cause pixel defects.

CARRY STRAP

- Once you have attached the carry strap, please make sure that the clips are mounted correctly to prevent the camera from falling.
- Carry straps are usually made of very robust material. You should therefore keep it out of the reach of children. A carry strap is not a toy and poses a strangulation risk.
- Use the carry strap only for its intended purpose on a camera or on binoculars. Any other use poses the risk of injury and may possibly result in damage to the carry strap and is therefore not permitted.
- Carry straps should also not be used for cameras/binoculars during sports activities that pose a risk of entanglement (e.g. when mountain climbing and similar outdoor activities).

TRIPOD

- When using a tripod, make sure it is standing securely and turn the camera only by turning the tripod, not the actual camera.
- Ensure that the tripod screw is hand-tightened only.
- Avoid transporting the camera while the tripod is attached. You might injure yourself or others and the camera could get damaged.

FLASH

- The use of incompatible flash units with your Leica M11 may result in irreparable damage to the camera and/or the flash unit.

REGULATORY INFORMATION

Specific regional approvals for this device can be found in the camera menu.

- ▶ Select **Camera Information** in the main menu
- ▶ Select **Regulatory Information** in the submenu

~ Alternating current (AC)

— Direct current (DC)



Class II devices (the product has a double-insulated design)

DISPOSAL OF ELECTRICAL AND ELECTRONIC EQUIPMENT

(Applies within the EU and for other European countries with active waste separation policies.)



This device contains electric and/or electronic components which must not be disposed of in general household waste. Instead, it should be disposed of at a recycling collection point provided by your local authority. This service is free of charge. Any standard or rechargeable batteries used in this device must be removed and disposed of separately in accordance with local regulations.

Please contact your local authorities, waste disposal collection point or the retailer, from whom you purchased the device for more information on correct waste disposal.

CE MARK

English

Declaration of Conformity (DoC)

Hereby, "Leica Camera AG" declares that this product is in compliance with the essential requirements and other relevant provisions of Directive 2014/53/EU.

Customers can download a copy of the original DoC to our Radio Equipment products from our DoC server:

www.cert.leica-camera.com

Please contact Leica Camera AG, Am Leitz-Park 5, 35578 Wetzlar, Germany in case of any further questions

Depending on product (see technical data)

Type	Frequency band (center frequency)	Maximum output (dBm E.I.R.P.)
WLAN	2412-2462/5180-5240 MHz/	20
	5260-5320/5500-5700 MHz	
	5735-5825 MHz	
Bluetooth® Wireless Technology	2402-2480 MHz	20

The CE mark on our products documents compliance with the fundamental requirements of applicable EU guidelines.

WARRANTY

In addition to your statutory warranty rights regarding your dealer, you will receive an additional Leica Camera AG product warranty valid from the date of purchase at an authorized Leica retailer. Previously, the product warranty was included with the product in the packaging. From now on, the product warranty will only be available online as a new service. You will be able to review the warranty conditions for your product at any time, without having to search for the document. Please note that this new policy applies only for products that are no longer delivered with a hardcopy product warranty included in the packaging. Any products still delivered with the warranty document in the packaging remain governed exclusively by that document. For more information regarding the warranty scope, services and limitations, please visit: warranty.leica-camera.com

FOR US ONLY:

FCC Note:

This equipment has been tested and found to comply with the limits for a Class B digital device, pursuant to Part 15 of the FCC Rules. These limits are designed to provide reasonable protection against harmful interference in a residential installation. This equipment generates, uses, and can radiate radio frequency energy and, if not installed and used in accordance with the instructions, may cause harmful interference to radio communications. However, there is no guarantee that interference will not occur in a particular installation. If this equipment does cause harmful interference to radio or television reception, which can be determined by turning the equipment off and on, the user is encouraged to try to correct the interference by one or more of the following measures:

- Reorient or relocate the receiving antenna.
- Increase the separation between the equipment and receiver.
- Connect the equipment into an outlet on a circuit different from that to which the receiver is connected.
- Consult the dealer or an experienced radio/TV technician for help.

FCC Caution:

To assure continued compliance, follow the attached installation instructions and use only shielded interface cables with ferrite core when connecting to computer or peripheral devices. Any changes or modifications not expressly approved by the party responsible for compliance could void the user's authority to operate this equipment.

Trade Name:	LEICA
Type No.	2416
Responsible party/Support contact:	Leica Camera Inc. 1 Pearl Count, Unit A, Allendale, New Jersey 07401 Tel.: +1 201 995 0051 / Fax: +1 201 995 1684 technicalinfo@leicacamerausa.com



This device complies with Part 15 of the FCC Rules. Operation is subject to the following two conditions:
 (1) This device may not cause harmful interference, and
 (2) this device must accept any interference received, including interference that may cause undesired operation.



A recyclable lithium ion/polymer battery powers this camera. Please call 1-800-8-BATTERY for information on how to recycle this battery.

FCC ID: N5A2416

This transmitter must not be co-located or operated in conjunction with any other antenna or transmitter. This equipment complies with FCC radiation exposure limits set forth for an uncontrolled environment and meets the FCC radio frequency (RF) Exposure Guidelines.

FOR CANADA ONLY:**CAN ICES-3 (B)/NMB-3(B) IC: 11245A-2416**

This device complies with Industry Canada licence-exempt RSS standard(s). Operation is subject to the following two conditions:

- (1) This device may not cause harmful interference,
- (2) This device must accept any interference received, including interference that may cause undesired operation of the device. This equipment complies with IC radiation exposure limits set forth for an uncontrolled environment and meets RSS-102 of the IC radio frequency (RF) Exposure rules.

FOR US AND CANADA ONLY:

This equipment is tested for specific absorption ratio (SAR) and complies with FCC/IC radiation exposure limits set forth for an uncontrolled environment. This device complies with FCC/IC SAR limit of 1.6 W/kg. For body worn operation, this equipment has been tested and meets the FCC/IC RF exposure guidelines when used with the Leica Camera AG accessories supplied or designated for this product that have no metallic component in the assembly. Use of other accessories may not ensure compliance with FCC/IC RF exposure guidelines.

FOR UK ONLY**FOR SINGAPORE ONLY**

Complies with
IMDA Standards DA106734

FOR UNITED ARAB EMIRATES ONLY

REGISTERED No: ER98767/21
DEALER No: DA0112968/13

Made for
 iPhone | iPad

Use of the Made for Apple badge means that an accessory has been designed to connect specifically to the Apple product(s) identified in the badge and has been certified by the developer to meet Apple performance standards. Apple is not responsible for the operation of this device or its compliance with safety and regulatory standards. Please note that the use of this accessory with an Apple product may affect wireless performance. Apple®, Apple TV®, Apple Watch®, iPad®, iPad Air®, iPad Pro®, iPhone®, and Lightning® are trademarks of Apple Inc., registered in the U.S. and other countries. tvOS® is a trademark of Apple Inc.