



LEICA D-LUX 7

INSTRUCTIONS

All new
Leica Fotos
functions

OK

Finding the information you need

In these instructions, you can find the information you need on the following pages.

“Contents”	4
List of Function Names	9
List of Buttons and Dials	16
Search from the List of Screens and Icons	264
“Message Displays”	270
“Menu List”	166
“Troubleshooting”	272

For details on how to use these instructions, see the next page.

How to use these instructions

About the indication of the applicable mode

Applicable modes:   **P A S M**

The icons indicate the modes available for a function.

- Black icons: Applicable modes
- Gray icons: Unavailable modes

■ About the symbols in the text

MENU: Indicates that the menu can be set by pressing [MENU/SET].

Wi-Fi: Indicates that the Wi-Fi settings can be made by pressing [Wi-Fi].



[AE/AF], [DISP], [], etc. indicate the respectively labeled buttons.





: Tips for skillful use and points for recording.

: Conditions in which a particular function cannot be used.

(→00) Indicates the reference page.

In these instructions, steps for setting a menu item are described as follows:

MENU →  **[Rec]** → **[Quality]** → []

- These instructions indicate the up, down, left, and right cursor buttons as ///.

Contents

Finding the information you need.....	2
How to use these instructions	3
Contents by Function	9

1. Before Use

Care of the Camera.....	12
Scope of Delivery	14
Accessories.....	15
Names and Functions of the Main Parts	16

2. Getting Started/Basic Operations

Attaching the Lens Cap/Shoulder Strap	18
Charging the Battery	20
• Inserting the battery	21
• Charging	22
• Approximate operating time and number of recordable pictures.....	25
Inserting and Removing the Card	26
Card Information	27
• Formatting the Card (initialization)	28
• Approximate number of recordable pictures and available recording time.....	29
Setting Date/Time (Clock Set).....	31
Basic Operations.....	33
• How to hold the camera	33
• Using the Viewfinder.....	34
• Zooming (changing the lens' focal length).....	35
• Taking pictures	36
• Recording videos.....	37
• Selecting the exposure control mode	37
• Control dial	39
• Cursor/[MENU/SET] buttons	39
• [DISP] button	39
• Touch screen operations	42
• Taking pictures using the touch function	43
Setting menu items	45
Quick Menu	47
• Customizing the Quick Menu settings	48
Assigning Frequently-Used Functions to Function Buttons	49
Changing Settings using the Control Ring	53
• Changing the function assigned to the Control Ring	54
Entering Text	55

3. Exposure Control Modes

The Snapshot Modes	56
• [Snapshot Mode] menu	59
• Taking pictures with customized color, defocus control, and brightness settings	60
Program Mode	61
Setting Aperture and/or Shutter Speed	63
• Confirming the effects of the aperture and shutter speed settings (Preview Mode)	69
Registering your preferred settings (Custom Set)	70
• Registering personal menu settings (Registering custom settings)	70
• Calling up a registered set of custom settings	70

4. Focus, Exposure Compensation and Color tone Settings

Automatic Focusing	72
• Setting the focusing mode (AFS/AFF/AFC)	74
• Setting the Autofocus mode	75
• Changing the position and size of the AF area	81
• Moving the AF area by Touch Control	84
• Optimizing brightness using Touch Control	85
Taking Close-up Pictures	86
Manual Focusing	87
Focus and Exposure Memory Lock (AF/AE Lock)	89
Exposure Compensation	90
Setting the ISO Sensitivity	92
Adjusting the White Balance	94
• Finely adjusting the White Balance	96

5. 4K Photo and Shutter Release Settings

Selecting a Shutter Release Mode	97
Using Continuous Mode	98
Recording 4K Pictures	100
• Notes on the 4K Photo function	102
Selecting Pictures from 4K Picture Series Files and Saving them	105
• Operations during selecting pictures	106
Selecting the Focusing Plane After Recording (Post Focus/Focus Stacking)	110
• Selecting the pictures with the desired focus settings and saving a picture ([Post Focus])	112
• Merging multiple pictures to expand the area rendered sharply (Focus Stacking)	113
Taking Pictures with the Self-timer	115
Recording panorama pictures	117

6. Recording Images that Suit Your Subjects and Purposes

Changing the Aspect Ratio	121
Taking Pictures with Different Image Effects (Filter).....	122
• Types of image effects.....	124
• Taking a picture with and without an image effect simultaneously ([Simultaneous Record w/o Filter])	128
Taking Picture Series with Automatically Changing Settings (Bracket Recording)	129
• Exposure Bracketing	131
• Aperture Bracketing.....	131
• Focus Bracketing.....	132
• White Balance Bracketing	132
Taking Pictures Automatically at Set Intervals ([Time Lapse Shot])	133
Creating Stop Motion Pictures ([Stop Motion Animation])	136

7. Stabilizer, Zoom and Flash

Compensating Camera Shake	139
Using the Lens' Zoom Function	141
• Zoom types and use	141
• Zooming using touch operations (Touch zoom)	145
Using the Supplied Flash Unit.....	146
• Attaching the flash unit	146
Setting the Flash Functions.....	148
• Changing the flash control mode.....	148
• Changing the flash modes.....	149
• Setting 2nd Curtain Sync.....	150
• Flash exposure compensation	151
• Synchronizing the output of the flash to the exposure compensation set for the ambient light.....	151

8. Recording Videos

Recording Videos.....	152
• Setting the resolution/frame rate combination	154
• How to set the focusing mode when recording a video ([Continuous AF])...	155
• Recording pictures while recording videos	156
• Displaying/setting the sound recording level	157

9. Playing Back and Editing Images

Playing Back Pictures	158
Playing Back Videos	159
• Creating pictures from a video	160
Switching the Playback Method	161
• Using the playback zoom	161
• Displaying multiple screens (Multi Playback)	162
• Displaying pictures by recording date (Calendar Playback)	162
Playing Back Group Pictures	163
Deleting Pictures	165

10. Using Menu Functions

Menu List	166
• [Snapshot Mode] menu	166
• [Rec] menu	166
• [Motion Picture] menu	179
• [Custom] menu	180
• [Setup] menu	195
• [My Menu] menu	204
• [Playback] menu	205

11. Using the Wi-Fi/Bluetooth function

What You Can Do with the Wi-Fi®/Bluetooth® Function	222
Wi-Fi function/Bluetooth function	223
Connecting to a smartphone	225
• Installing the smartphone/tablet “Leica FOTOS” app	225
• Connecting the camera to a smartphone compatible with Bluetooth Low Energy	226
• Connecting the camera to a smartphone that does not support for Bluetooth Low Energy	228
• Changing the Wi-Fi connection method	231
• Terminating the Wi-Fi connection	232
Operating the Camera with a Smartphone	233
• Turning on/off the camera with a smartphone	233
• Taking images via a smartphone (remote recording)	234
• Operating the shutter button with a smartphone via a Bluetooth connection alone	236
• Playing back/saving images stored on the camera, or uploading them on social media sites	238
• Transferring recorded images to a smartphone automatically	239
• Writing location information of a smartphone on a recorded image	241
• Synchronizing the camera’s clock with a smartphone	242
Sending Images	243

About Wi-Fi Connections	247
• Connecting via a wireless access point ([Via Network])	248
• Connecting the camera and another device directly ([Direct])	250
• Connecting quickly with the same settings as the previous ones ([Select a destination from History])/([Select a destination from Favorite])	251
[Wi-Fi Setup] Menu	253

12. Connecting to other equipment

Watching/Saving 4K Videos on an External Device	254
• Watching videos in 4K	254
• Storing 4K videos	254
Playing Back on a TV	255
• Using HDTV Link (HDMI)	256
Copying the Recorded Image Data to a Computer	257
• Transferring images to a computer	258
Saving Pictures and Videos on a Recorder	260
Printing Pictures	261
• Adding date and text to pictures	263

13. Others

Monitor Display/Viewfinder Display	264
Message Displays	270
Troubleshooting	272
Usage Cautions and Notes	281
Leica Service Addresses	289

Contents by Function



Recording

Recording

Recording Mode	37
[Preview]	69
Macro recording	86
Bracket Recording	129
[Time Lapse Shot]	133
[Stop Motion Animation]	136
[Silent Mode]	175
[Multi Exp.]	178

4K photo

[4K PHOTO]	100
[Post Focus]	110

Focus (AF/MF)

Autofocus	72
[AF Mode]	75
Adjusting the AF area position	81
Manual Focus	87
[AF/AE Lock]	89

Drive

[Drive Mode]	97
[Burst]	98
[Self Timer]	115
Panorama	117

Picture Quality and Color Tone

[Sensitivity]	92
[White Balance]	94
[Filter Settings]	122
[Picture Size]	167
[Quality]	168
[Photo Style]	169
[Color Space]	171
[Highlight Shadow]	172
[i.Dynamic]	173
[i.Resolution]	173
[Long Shtr NR]	174
[Diffraction Compensation]	175
[HDR]	177

Exposure

[Touch AE]	44
[AF/AE Lock]	89
Exposure Compensation	90
Exposure Bracket	131
[Metering Mode]	171

Flash

[Flash Mode]	149
2nd curtain synchro	150
[Flash Adjust.]	151



Motion Picture

Motion Picture

[Rec Quality]	154
Recording pictures while recording videos	156

Audio

[Sound Rec Level Adj.]	157
[Wind Noise Canceller]	179

Screen settings

[Sound Rec Level Disp.]	157
[Monochrome Live View]	187
[Center Marker]	189
[Zebra Pattern]	190



Setup/Custom

Basic settings

[Format]	28
[Clock Set]	31
Diopter adjustment	34
[Q.MENU]	47
[Beep]	197
[Economy]	198
[Reset] (initialization)	203

Customization

Function buttons	49
Custom Set	70
[Custom] menu	180



Playback

Playback

Picture playback	158
Video playback	159
Playback Zoom	161
Multi Playback	162
Delete	165
[Auto Review]	186
[Slide Show]	206
[Rotate]/[Rotate Disp.]	219, 220

Edit

Post Focus	112
Focus Stacking	113
[Title Edit]	209
[RAW Processing]	210
[4K PHOTO Bulk Saving]	212
[Light Composition]	213
[Sequence Composition]	214
[Clear Retouch]	215
[Text Stamp]	216
[Resize]	217
[Cropping]	218

Image settings

[Protect]	208
[Rating]	208



Wi-Fi/Bluetooth

Smartphone/tablet app “Leica FOTOS”

“Leica FOTOS” app..... 225
 [Remote Wakeup]..... 233

Remote recording 234
 [Auto Transfer] 239



Connections with other devices

<p>PC Copying the Recorded Image Data to a Computer 257</p> <p>TV Playing Back Pictures on a TV Screen 255 [HDTV Link] 256</p>	<p>Recorder Dubbing 260</p> <p>Printer PictBridge 261</p>
---	---

Care of the Camera

■ Handling of the camera

Do not subject it to strong vibration, shock, or pressure.

Avoid using the camera under the following conditions, which may damage the lens, the monitor, the viewfinder, or the external casing.

This may also cause the camera to malfunction or prevent recording.

- Dropping or hitting the camera.
- Sitting down with the camera in your pants pocket or forcing it into a full bag.
- Press hard on the lens or the monitor.

The camera is not dust resistant, splash resistant, or waterproof.

Avoid using the camera in places with excessive dust or sand, or where water can come into contact with the camera.

- Avoid using the camera under the following conditions, which present a risk that sand, water, or foreign material may enter the camera through the lens or the gaps around buttons. Be especially careful because these conditions may damage the camera, and such damage may not be repairable.
 - In extremely dusty or sandy places.
 - In the rain or by the shore, where the camera may be exposed to water.

■ About Condensation (When the lens, the viewfinder or monitor is fogged up)

- Condensation occurs when the ambient temperature or humidity changes. Be careful of condensation since it may cause stains on the lens, the viewfinder and the monitor, fungus and camera malfunction.
- If condensation occurs, turn the camera off and leave it for about 2 hours. The fog will disappear naturally when the temperature of the camera becomes close to the ambient temperature.

■ **Always record a test image first**

Before important events when you intend to use the camera (at weddings, for example), always record a test image to ensure that images and sound record correctly.

■ **No compensation for missed shots**

Leica Camera AG cannot compensate for missed shots if technical problems with the camera or memory card prevent images and/or sound from being recorded.

■ **Carefully observe copyright laws**

Unauthorized use of recorded images and sound that contain works with copyright for purposes other than personal use is prohibited under copyright law. Recording of certain material may be restricted even for the purpose of personal use.

■ **Please also refer to “Usage Cautions and Notes” (→281)**

Scope of Delivery

	Order No.
Rechargeable battery pack	
BP-DC15-E	423-109.001-008
BP-DC15-U	423-109.002-008
BP-DC15-TK	423-109.003-008
Battery charger/AC adapter	
ACA-DC16-E	423-118.001-005
ACA-DC16-C	423-118.001-006
ACA-DC16-K	423-118.001-007
ACA-DC16-B	423-118.001-008
ACA-DC16-N	423-118.001-009
ACA-DC16-A	423-118.001-010
ACA-DC16-U	423-106.001-012
USB Cable Micro-B	423-118.001-014
Shoulder strap	423-109.001-020
Lens cap*	423-109.001-018
Lens cap string	423-109.001-019
Hot shoe cover*	423-110.001-015
Flash unit CF D	423-109.001-030
Button template	19542
Short instructions	(delivery differs depending on markets)
Guarantee Card	439-399.100-026

* This is attached/inserted to the camera at the time of purchase.

Accessories

Please visit the Leica Camera AG website for information on the extensive range of Leica D-Lux 7 accessories:

www.leica-camera.com

Notes:

- Memory cards are optional.
- The battery charger/AC adapter is indicated as charger in the text.
- SD/SDHC/SDXC memory cards are referred to as cards in these instructions.
- Check that all items belonging to the scope of delivery are included before using the camera.
- Depending on the country or area where the camera was purchased, the items and their shape may differ from the descriptions and illustrations in these instructions.
- Keep the lens cap string and the hot shoe cover out of reach of children to prevent swallowing.
- Always keep small parts in a safe place out of the reach of children.
- Please dispose of all packaging appropriately.

Names and Functions of the Main Parts

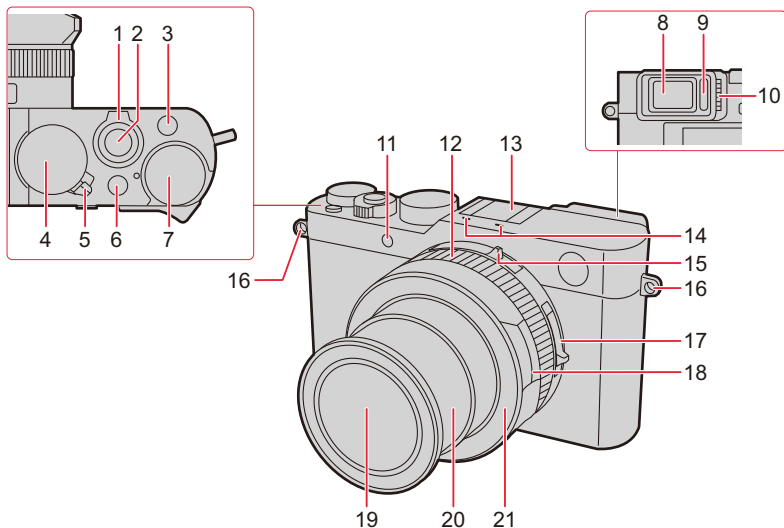

1	Zoom lever (→35)	13	Hot shoe (The hot shoe cover is inserted at the time of purchase.) (→146)
2	Shutter button (→36)		Stereo microphones (→33, 157)
3	[4K] button (→100)/[Fn1] button (→49)	14	• Be careful not to cover the microphones with your fingers. Doing so may impair sound recording.
4	Shutter speed dial (→37, 63)	15	Aspect ratio selector switch (→121)
5	Camera ON/OFF switch (→31)	16	Strap eyelets (→18)
6	[A] button (→38, 56)	17	Focus mode selector switch (→72, 86, 87)
7	Exposure compensation dial (→90)	18	Aperture ring (→37, 63)
8	Viewfinder (→34)	19	Front lens element (Filter diameter: \varnothing 43mm)
9	Eye sensor (→34)	20	Lens barrel
10	Diopter adjustment dial (→34)		Lens front ring
11	Self-timer indicator (→115)/ AF Assist Lamp (→33, 182)	21	• To attach the auto lens cap (optional), first remove this front ring.
12	Control ring (→53)		

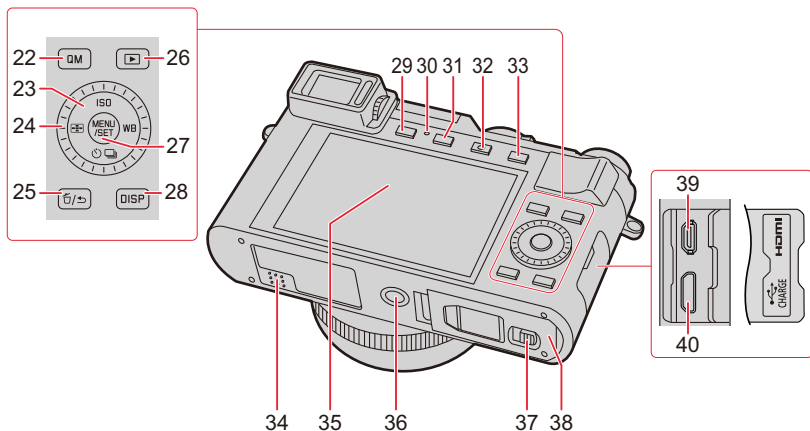

22	[QM] button (→47)/[Fn2] button (→49)
23	Cursor buttons (→39) ▲: [ISO] (ISO sensitivity) button (→92)
24	▶: [WB] (White Balance) button (→94) ▼: [Drive Mode] (→97) ◀: [Autofocus mode] button (→72)
24	Control dial (→39)
25	[Delete/Cancel] button (→46, 165)/ [Fn3] button (→49, 69)
26	[Playback] button (→158)
27	[MENU/SET] button (→39, 45)
28	[DISP] button (→39)
29	[EVF] button (→34)/[Fn5] button (→49)
30	Charging lamp (→22)/ WIRELESS connection lamp (→223)
31	[PF] button (→110)/[Fn4] button (→49)

32	[Video] button (→152)
33	[AE/AF] button (→89)
34	Speaker (→33, 197)
35	Monitor (→264)/ with touch control options (→42)
36	Tripod thread (→284) • It may not be possible to attach and securely fasten a tripod with a screw length of 5.5mm (7/32") or more to the camera. Doing so may also damage the camera.
37	Release slider (→21, 26)
38	Card/Battery door (→21, 26)
39	[HDMI] socket (→255)
40	[USB/CHARGE] socket (→258, 261)

• **Function buttons [Fn6] to [Fn10] are touch icons.**

They can be called up by touching the [Fn] tab on the monitor screen.

Attaching the Lens Cap/Shoulder Strap

When the camera is not in use, always attach the lens cap to protect the lens.

- We recommend attaching the lens cap to the camera using the lens cap string to prevent loss of the lens cap.
- Attach the shoulder strap when using the camera to prevent it from dropping.

1 Use the lens cap string to attach the lens cap to the camera.

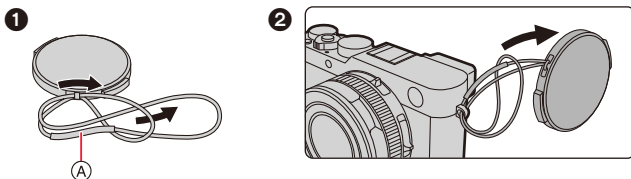

- (A): Make sure that the thicker section of the string is not hanging over the lens cap or the strap eyelet.

2 Attach the lens cap.

- To attach and remove the lens cap, press the tabs shown by arrows in the illustration.

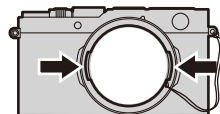

3 Attach the shoulder strap.

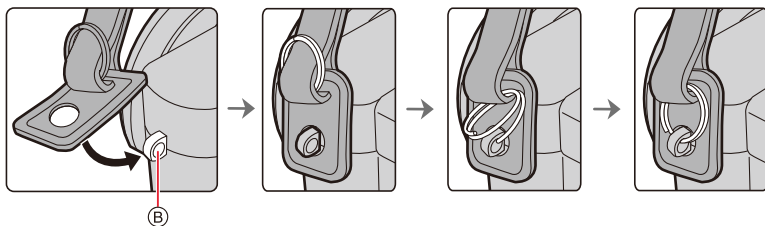

Ⓑ: Strap eyelet

- In addition, attach the other side of the shoulder strap in the same manner.
 - Make sure the shoulder strap does not come loose.
- Use the shoulder strap around your shoulder.
 - Do not wrap the strap around your neck.
It may result in injury or accident.
 - Do not leave the shoulder strap where small children can reach it.
 - It may result in an accidental suffocation.
 - Keep the lens cap string out of reach of children to prevent swallowing.

Charging the Battery

- Use the dedicated charger, USB cable and battery.
- **The battery is not charged when the camera is shipped. Charge the battery before use.**
- **The battery can only be charged when it is inserted in the camera.**

Camera conditions	Charging process
Turned off	○
Turned on	—

■ About batteries that you can use with this camera

It has been found that counterfeit batteries which look very similar to the genuine product are available in some markets. Some of these batteries are not adequately equipped with internal protection to meet the requirements of appropriate safety standards. Using such batteries may lead to fire or explosion. Please be advised that Leica Camera AG is not liable for any accident or failure occurring as a result of use of a counterfeit battery. To ensure that safe products are used we urgently recommend to use only the Leica battery BP-DC15 (→14).

Inserting the battery

1 Move the release slider **(A)** to the [OPEN] position and open the card/battery door.

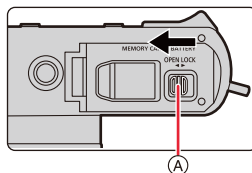

2 Insert the battery **(B)** all the way in until you hear a clicking sound, and then confirm that it is locked by the latch **(C)**.

- Check the orientation of the battery.

3 Close the card/battery door and move the release slider to the [LOCK] position.

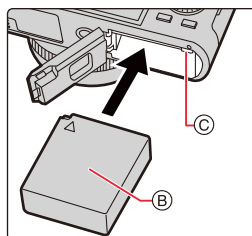

■ To remove

Pull the latch **(D)** in the direction of the arrow.

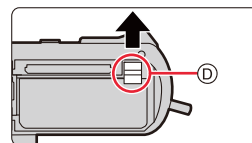

- Use only the Leica battery BP-DC15 (→14).
- Leica Camera AG cannot guarantee the quality of any other type of battery.
- Turn the camera off and wait for the Leica logo on the monitor to disappear before removing the battery. (Otherwise, this camera may no longer operate normally and the card itself may be damaged or the recordings may be lost.)
- Remove the battery after use.

Charging

We recommend to charge the battery in areas with an ambient temperature, between 10°C and 30°C (50°F and 86°F) (same as the battery temperature).

Insert the battery into the camera. (→21)
Check that the camera on/off switch is set to [OFF].

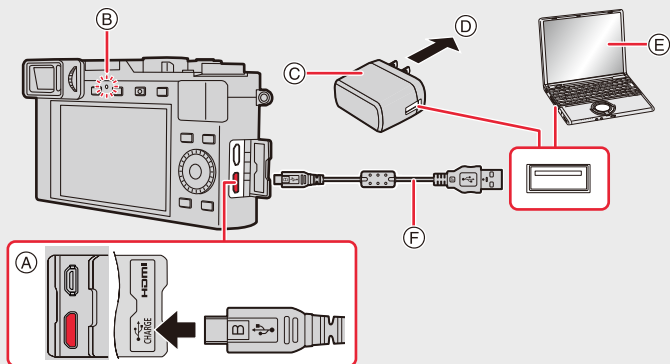

- (A) Connect the USB cable to the [USB/CHARGE] socket.
- Place the camera in an upright position; use the lower of the two terminals.
- (B) Charging lamp
- (C) Charger
- (D) To power outlet
- (E) Computer (Turned on)
- (F) USB cable

- Make sure that the plugs are aligned correctly and that they are inserted straight. (Otherwise their pins may be bent which may cause malfunction or even the camera to be damaged.)

(Charging from the power outlet)

Connect the charger and the camera with the USB cable, and insert the charger into the power outlet.

(Charging from a computer)

Connect the computer and this camera with the USB cable.

- If the computer enters a suspended state while charging the battery, charging will stop.
- Connecting the camera to a notebook computer that is not connected to a power outlet will cause the notebook computer battery to drain faster. Do not leave the camera connected for extended periods of time.
- Be sure to always connect the camera to a computer USB terminal. Do not connect the camera to a monitor, keyboard or printer USB terminal, or a USB hub.

■ Charging lamp

Lit red: Charging.

Off: Charging has completed.
(When charging is complete, disconnect the camera from the power outlet or computer.)

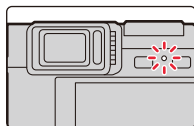

• When the charging lamp flashes

- This occurs when charging is performed in an extremely hot or cold location. Reconnect the USB cable in a location where the ambient temperature (and the temperature of battery) is in a 10°C to 30°C (50°F to 86°F) range, and try charging again.
- If your computer is not capable of supplying sufficient power, charging is not possible.

■ Charging time

When using the charger

Charging time

Approx. 190min

- The indicated charging time is for when the battery has been discharged completely. The charging time may vary depending on how the battery has been used. The charging time for the battery in hot/cold environments or one that has not been used for a long time may be longer than normal.
- When power is supplied from a computer, the power supply capacity of the computer determines the charging time.

■ Battery indication

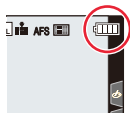

	75% or higher
	74% to 50%
	49% to 25%
	24% or below
 Flashing red	Low battery • Recharge the battery or replace it with a fully charged battery.

- The battery level indicated on the monitor screen is approximate. The exact level varies depending on the environment and the operating conditions.

- **Do not leave any metal items (such as clips) near the power plug pins. Otherwise, a fire and/or electric shocks may be caused by short-circuiting or the resulting heat generated.**
- Do not use any other USB cables except the supplied one.
This may cause malfunction.
- Do not use any other chargers except the supplied one.
This may cause malfunction.
- Do not use a USB extension cable.
- Do not use the charger and the USB cable for other devices. Doing so may cause malfunction.
- Remove the battery after use. (The battery will be exhausted if left for a long period of time after being charged.)
- **The battery gets warm after using and during and after charging. The camera also gets warm during use. This is not a malfunction.**
- The battery can be recharged even when it still has some charge left, but it is not recommended that the battery charge be frequently topped up while the battery is fully charged. (Since characteristic swelling may occur.)
- If a problem occurs in the power outlet, such as a power outage, charging may not be completed normally. If this happens, disconnect the USB cable and connect it again.
- The charger is in the standby condition when the mains plug is connected. The primary circuit is always “live” as long as the mains plug is connected to an electrical outlet.

Approximate operating time and number of recordable pictures

- The numbers of recordable pictures listed here are based on the CIPA (Camera & Imaging Products Association) standard.
- When a SDHC memory card and the supplied battery are used.

■ Recording pictures (when using the Monitor)

Supplied flash unit attached	Not used	Used
Number of recordable pictures	Approx. 340	Approx. 300
Recording time	Approx. 170 min	Approx. 150 min

■ Recording pictures (when using the viewfinder)

The values inside the parentheses apply when [EVF Display Speed] is set to [ECO30fps].

Supplied flash unit attached	Not used	Used
Number of recordable pictures	Approx. 270 (Approx. 320)	Approx. 240 (Approx. 280)
Recording time	Approx. 135 min	Approx. 120 min

■ Recording videos (when using the monitor)

[Rec Quality]	[FHD/28M/60p]	[4K/100M/30p]
Available recording time	Approx. 80 min	Approx. 70 min
Actual available recording time	Approx. 40 min	Approx. 35 min

- The actual recordable time is the time available for recording when repeating actions such as turning the camera on and off, starting/stopping recording, etc.

■ Playback (when using the monitor)

Playback time	Approx. 240 min
---------------	-----------------

• The operating times and number of recordable pictures will differ according to the environment and the operating conditions.

For example, in the following cases, the operating times are shorter and the number of recordable pictures is reduced.

- In low-temperature environments, such as in winter.
- When a function such as the use of flash or the zoom is used repeatedly.
- When the operating time of the camera becomes extremely short even immediately after charging, the life of the battery has expired. Buy a new battery.

Inserting and Removing the Card

- Check that the camera on/off switch is set to [OFF].

1 Move the release slider (A) to the [OPEN] position and open the card/battery door.

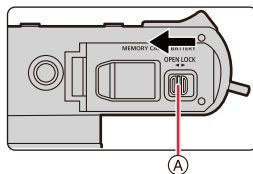

2 Insert the card (B) all the way in until you hear a clicking sound.

- Check the orientation of the card.
- Do not touch the card terminals (C).

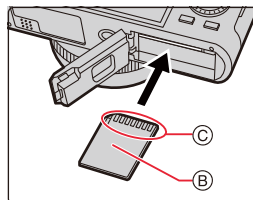

3 Close the card/battery door and move the release slider to the [LOCK] position.

■ To remove the card

Push it down until it clicks and then pull it straight out.

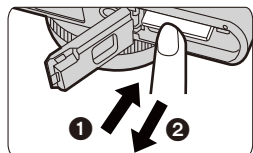

- Keep cards out of reach of children to prevent swallowing.
- Turn the camera off and wait for the Leica logo on the monitor to disappear before removing the card. (Otherwise, the camera may no longer operate normally and the card itself may be damaged or the recordings may be lost.)

Card Information





The following cards which conform to the SD standard can be used with this camera.

SD Memory Card (512 MB to 2 GB)	<ul style="list-style-type: none"> This camera is compatible with UHS-I UHS Speed Class 3 standard SDHC/SDXC memory cards.
SDHC Memory Card (4 GB to 32 GB)	
SDXC Memory Card (48 GB to 128 GB)	

■ Recording of videos/4K pictures and speed class ratings

Use a card that meets the following ratings of the SD Speed Class or UHS Speed Class.

- SD Speed Class and UHS Speed Class are the speed standards regarding continuous writing. To check the class, see the labeled side, etc. of the card.

[Rec Quality]	Speed class	Label example
FHD/HD	Class 4 or higher	CLASS  
4K	UHS Speed Class 3	
When recording in 4K Photo/ [Post Focus]	UHS Speed Class 3	

Access to the card

The access indication is displayed in red when image data is being written to the card.



• **Do not perform the operations below while the card is being accessed (while image data is being written or read or deletion or formatting is in progress, for example). These operations may damage the card or recorded data or cause the camera to stop functioning correctly.**

- Turning off the camera
- Removing the battery or card, or disconnecting the charger
- Exposing the camera to vibration, impact or static electricity

• **If an operation fails due to vibration, impact or static electricity, perform it again.**

- If you set the Write-Protect switch (A) to "LOCK", you may not be able to write, delete or format the data or display it by recording date.
- The data on the card may be damaged or lost due to electromagnetic fields, static electricity or breakdown of the camera or the card. We recommend storing important data on a PC etc.
- Keep memory cards out of reach of children to prevent swallowing.

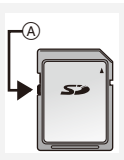

Formatting the Card (initialization)

Format the card before recording with this camera.

After formatting, all data stored on the card will be deleted and cannot be recovered. Back up necessary data on a computer or similar device first, and then format the card.

MENU → ↗ **[Setup]** → **[Format]**

- This requires a sufficiently charged battery, or the charger.
- Do not turn off the camera or perform other operations during formatting.
- Always format cards with this camera. Please reformat the card with this camera if it has already been formatted with a computer or another device.

Approximate number of recordable pictures and available recording time

■ Number of recordable pictures

- Aspect ratio [4:3], Quality [FINE]

[Picture Size]	Card capacity			
	16 GB	32 GB	64 GB	128 GB
L (17M)	1710	3430	6860	13580
EX M (8.5M)	3120	6260	12350	24460
EX S (4M)	5350	10730	20590	40760

- Aspect ratio [4:3], Quality [RAW:FINE]

[Picture Size]	Card capacity			
	16 GB	32 GB	64 GB	128 GB
L (17M)	530	1070	2150	4270
EX M (8.5M)	620	1250	2500	4960
EX S (4M)	680	1360	2720	5400

■ Available recording time (when recording videos)

- “h” is an abbreviation for hour, “m” for minute and “s” for second.
- The recordable time is the total time of all the videos which have been recorded.

[Rec Quality]	Card capacity			
	16 GB	32 GB	64 GB	128 GB
[4K/100M/30p] [4K/100M/24p]	20m00s	41m00s	1h25m	2h50m
[FHD/28M/60p]	1h10m	2h25m	5h00m	9h55m
[FHD/20M/30p]	1h35m	3h15m	6h40m	13h15m
[HD/10M/30p]	3h05m	6h20m	12h45m	25h20m

• **Continuous motion picture recordable times**

Motion picture recording stops when the continuous recordable times below have elapsed.

[Rec Quality]	Continuous recordable time	Size interval for dividing files
[4K/100M/30p]	15 minutes	When an SDHC card is used: Files exceeding 4 GB in size will be divided into smaller files for recording and playback.* When an SDXC card is used: Files are not divided for recording.
[4K/100M/24p]		
[FHD/28M/60p]	29 minutes	Files exceeding 4 GB in size will be divided into smaller files for recording and playback.*
[FHD/20M/30p]		
[HD/10M/30p]		

*Even so, you can continue recording without interruption.

- Depending on the recording conditions and the type of card, the number of recordable pictures and available recording time vary.
- **The maximum available continuous recording time is displayed on the screen.**
- [9999+] is displayed on the recording screen if there are 10000 or more recordable pictures remaining.

- 9** Press ◀/▶ to select the home area, and then press [MENU/SET].



■ Re-adjusting the clock

MENU →  [Setup] → [Clock Set]

- The same screen as in step 5 on (→31) is displayed.
- **The clock setting is maintained for 3 months using the built-in clock battery even without the battery.**
(Leave the charged battery in the camera for 24 hours to charge the built-in battery.)
- To place the correct date on pictures, set the clock before recording.

Basic Operations

How to hold the camera

Hold the camera firmly with both hands, keep your arms still at your side and stand with your feet slightly apart.

- We recommend using the supplied shoulder strap ④ to avoid dropping the camera.
- Do not cover the flash screen when a flash unit is attached and switched on (→146), the AF assist lamp ①, the microphones ②, or the speaker ③ with your fingers or other objects.
- Make sure you hold the camera completely still when you press the shutter button.
- Make sure your footing is stable and there is no danger of colliding with another person or object in the vicinity while taking pictures.

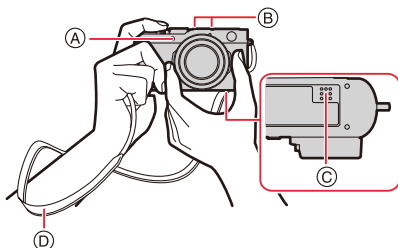

■ Detection of the orientation of the camera (Direction Detection Function)

This function detects the vertical orientation when you record with the camera held vertically.

When you play back the recording, it is automatically displayed in vertical orientation.

(Only available when [Rotate Disp.] is set to [ON].)

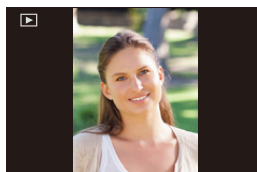

- When the camera is held vertically and tilted significantly up or down to record, the Direction Detection Function may not work correctly.
- Videos, 4K picture series files, and images recorded with the Post Focus function cannot be displayed vertically.

Using the Viewfinder

Switching between viewfinder and monitor displays

Press [EVF].

- (A) [EVF] button
- (B) Eye sensor

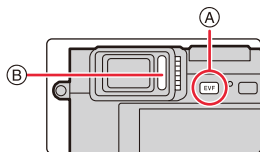

Automatic viewfinder/
monitor display
switching*

Viewfinder display*

Monitor display

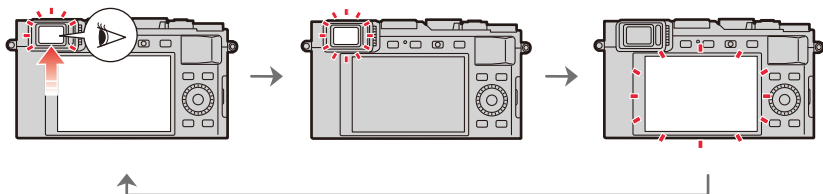

- * If [Eye Sensor AF] in the [Custom] ([Focus / Release Shutter]) menu is set to [ON], the camera automatically focuses as the eye sensor is activated. The camera does not beep when focus is successfully achieved with [Eye Sensor AF].

■ Notes on automatic viewfinder/monitor display switching

Bring your eye or an object near the viewfinder to automatically switch to the viewfinder display using the eye sensor.

Diopter adjustment

Rotate the diopter adjustment dial until you can see the characters displayed in the viewfinder clearly.





- If [EVF Display Speed] is set to [ECO30fps] when the viewfinder is used, the camera can be operated for a longer period since battery drainage is reduced.
- The eye sensor might not work properly depending on the shape of your eyeglasses, the way you hold the camera, or bright light shining into the eyepiece.
- Automatic viewfinder/monitor switching does not work during motion picture playback and slide shows.

Zooming (changing the lens' focal length)

You can determine how much of a subject is to be captured / how large a subject is to be rendered by selecting the appropriate focal length, i.e. by zooming.

- You can also use the zoom function from the touch panel. (→145)
- For details about zoom types and use, refer to (→141).

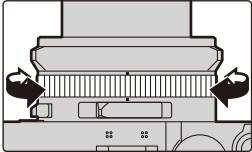
Zoom lever	Control ring
<p>Turn the zoom lever</p>  <ul style="list-style-type: none"> • The operation of the zoom lever is indicated as shown below in these instructions. <p>Rotate the zoom lever: </p> <p>[T] side: Telephoto, Enlarges the subject, reduces the captured area</p> <p>[W] side: Wide-angle, Captures a larger area, reduces the captured subjects' sizes</p>	<p>Turn the control ring*</p>  <ul style="list-style-type: none"> * You can perform zoom operation by assigning the [Zoom] setting to the control ring. (→54) <p>Clockwise: Telephoto, Enlarges the subject, reduces the captured area</p> <p>Counterclockwise: Wide-angle, Captures a larger area, reduces the captured subjects' sizes</p>

- Do not touch the lens barrel during zooming.
- Adjust the focus setting after zooming.
- The camera may make a rattling noise and vibrate when the zoom lever or control ring is operated. This is not a malfunction.

Taking pictures

The shutter button works in two steps.

1 Press the shutter button halfway to let the camera set exposure and focus.

- (A) Aperture value
- (B) Shutter speed
- (C) Focus confirmation

- Aperture value and shutter speed will turn red and flash if the exposure is not correct.
- Once the subject is in focus, the focus confirmation is displayed. (When the subject is not in focus, the confirmation flashes.)

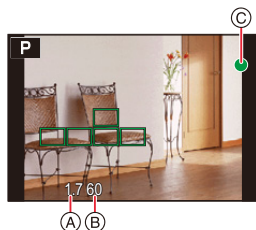
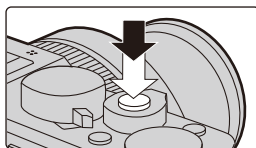

2 Press the shutter button fully down to take the picture.

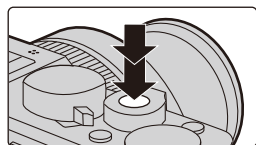

- Pictures cannot be taken until focus is achieved when [Focus/Release Priority] is set to [FOCUS].
- When [Monitor Display Speed] or [EVF Display Speed] (or both) is set to [ECO30fps], Digital Zoom is not available.
- Even during menu operation or image playback, if you press the shutter button halfway, you can instantly set the camera ready for recording.

Distance setting range

The possible distance setting range is displayed when zooming.

The distance setting range may change gradually depending on the zoom position.

- (D) Setting range indication



- The focusing range is displayed in red when it is not focused after pressing the shutter button halfway.

Recording videos

- 1 **Start recording by pressing the video button.**
 - Immediately release the video button.
- 2 **Stop the recording by pressing the video button again.**

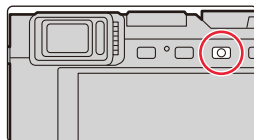

Selecting the exposure control mode

Turn the aperture ring **(A)** and/or the shutter speed dial **(B)**.

- Be sure to set both only to their click-stop positions.
- The exposure control mode will change according to the aperture ring and shutter speed dial settings.

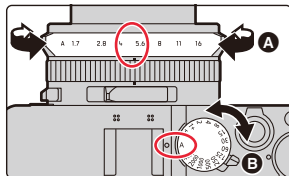

Exposure control mode	Aperture ring	Shutter speed dial
P Program mode	[A] (AUTO)	[A] (AUTO)
A Aperture-Priority mode	You set the desired value	
S Shutter-Priority mode	[A] (AUTO)	You set the desired value
M Manual Exposure mode	You set the desired value	

To switch to the Snapshot modes

Press [A].

- When the Snapshot modes are set, the exposure control mode icon changes to [A+] or [A].
- When you press [A] again, the exposure control mode is switched back to one that enables settings to be made using the aperture ring and shutter speed dial, i.e. one of the four described above.

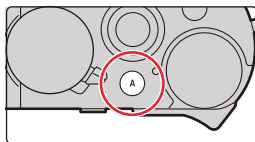

[A]	Snapshot mode (→56)	The camera chooses the optimal settings to match the subject and the recording conditions. We recommend these modes when you want to leave the settings to the camera and take pictures with ease.
[A+]	Snapshot Plus mode (→57)	



P	Program mode (→61)	The camera automatically sets the shutter speed and the aperture value according to the brightness of the subject.
A	Aperture-Priority mode (→64)	The camera automatically sets the shutter speed according to the brightness of the subject and the aperture value you set.
S	Shutter-Priority mode (→65)	The camera automatically sets the aperture value according to the brightness of the subject and the shutter speed you set.
M	Manual Exposure mode (→66)	You determine the exposure by manually setting the aperture value and the shutter speed.

Control dial

Rotate the dial to select items or set values etc.

- The operation of rotating the control dial to the left or right is illustrated as below in these instructions.

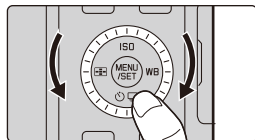

Cursor/[MENU/SET] buttons

Press the cursor buttons to select items or values etc.

- In these instructions, the cursor button to be used is indicated by ▲/▼/◀/▶.

Pressing [MENU/SET] to confirm set contents, etc.

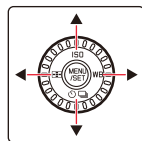

[DISP] button

Pressing [DISP] switches the display method.

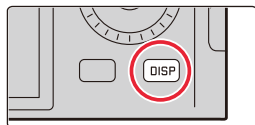

In recording mode

You can switch the viewfinder/monitor display method.

MENU → **[Custom]** → **[Monitor / Display]** → **[EVF/Monitor Disp. Set]** → **[EVF Disp. Set]/[Monitor Disp. Set]**

(viewfinder style)	Scales down images slightly so that you can better review the composition of the images.
(monitor style)	Scales images to fill the entire screen so that you can see their details.

• Viewfinder style (viewfinder display shown as example)

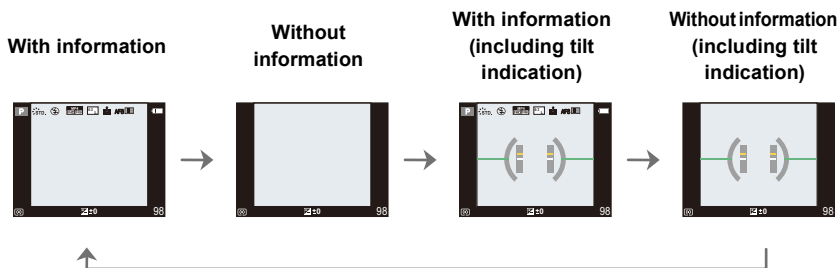

• Monitor style (monitor display shown as example)

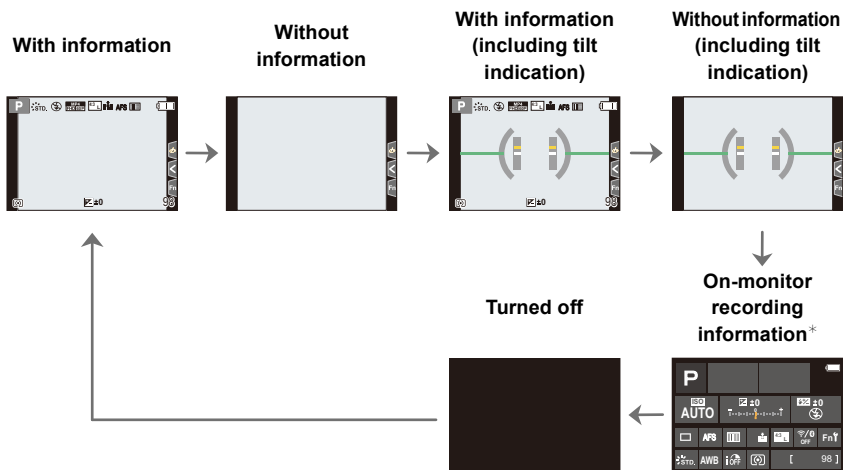

* Displayed when [Monitor Info. Disp.] in the [Custom] ([Monitor / Display]) is set to [ON]. You can touch the desired item and change its setting directly.

■ About the tilt indication display

With the tilt indication displayed, it is easy to correct the tilt of the camera etc.

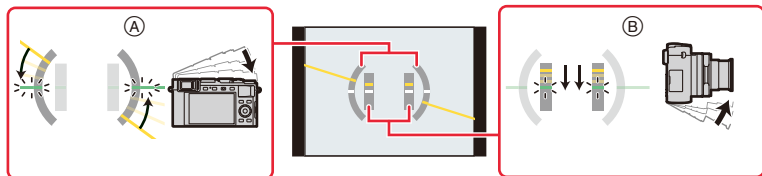

Ⓐ **Horizontal direction:** Correcting tilt to the left

Ⓑ **Vertical direction:** Correcting downward tilt

- When the camera is tilted very little or not at all, the level gauge will turn green.

- Even after correcting the tilt, there may still be an error of approximately $\pm 1^\circ$.

- When the camera is tilted significantly upwards or downwards, the tilt indication may not work correctly.

In playback mode

With information

Detailed
information
display*1

Without
information
(Highlight
display)*2

Without
information

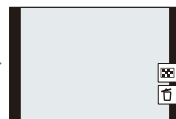
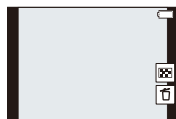
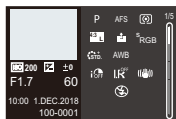
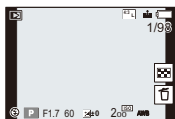

*1 Press $\blacktriangle/\blacktriangledown$ to switch between the following display modes:

- Detailed information display
- Histogram display
- Photo style, Highlight shadow display
- White balance display
- Lens information display

*2 Displayed if [Highlight] in the [Custom] ([Monitor / Display]) menu is set to [ON].

Touch screen operations

■ Touch:

Briefly touch the monitor screen at the desired place/icon to switch a function on or off.

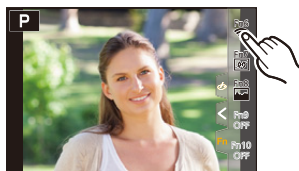

■ Drag:

Touch the monitor screen at the desired place/icon and swipe to the desired level to set a function.

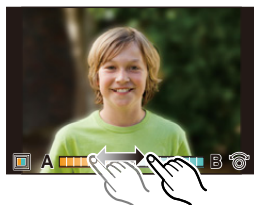

■ Pinch/Spread:

Touching the monitor screen with two fingers, move them apart to enlarge the image, move them together to reduce it.



- Touch the screen with a clean and dry finger.
- If you use a commercially available monitor protection foil, please follow the instructions that accompany it.
(Some monitor protection foils may impair visibility or operability.)







Not available in these cases:

- The touch screen operations may not function normally in the following cases.
 - When wearing gloves
 - When the monitor screen is wet

Taking pictures using the touch function

Touch AF/Touch Shutter

Available in the following modes:      



1 Touch .



2 Touch an icon.

- The icon switches every time you touch it.



 (Touch AF)	Focuses on the position you touch.*
 (Touch shutter)	Focuses on the touched position before recording takes place.*
 (OFF)	Touch AF and Touch Shutter are disabled.

- * When [Touch AF] in [Touch Settings] of the [Custom] ([Operation]) menu is set to [AF+AE], the focus and brightness settings are optimized for the touched position. (→85)

3 (When settings other than OFF are selected)
Touch the subject.

- When  (Touch AF) is set, refer to (→81) for information about the operation to change the size and position of the AF area.



- If shooting with the touch shutter fails, the AF frame turns red and disappears.

Touch AE

Available in the following modes: **A AF P A S M**

You can easily optimize the brightness for a touched position. E.g., when the face of the subject appears dark, you can brighten the exposure to achieve a brighter rendering of the face.

1 Touch [**<**].



2 Touch [**AE**].

- The setting screen for the brightness optimization position is displayed.
- [Metering Mode] is set to [**AE**], which is used exclusively for the Touch AE.



3 Touch the subject you want to optimize the brightness for.

- Touch [Reset] to bring the brightness optimization position back to the center.



4 Touch [Set].

■ Canceling the Touch AE function:

Touch [**OFF AE**].

Not available in these cases:

- When using Digital Zoom
- When [Touch AF] in [Touch Settings] of the [Custom] ([Operation]) menu has been set to [AF+AE]

Setting menu items

You can set menu items either by using the cursor buttons or with touch operations.





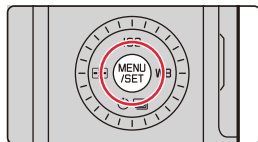

1 Press [MENU/SET] to display the menu.

2 Press ◀.



3 Press ▲/▼ to select a menu section icon, such as [📷].



 [Snapshot Mode] (→59)	This menu section is for setting the functions available in the Snapshot modes.
 [Rec] (→166)	This menu section is for picture settings.
 [Motion Picture] (→179)	This menu section is for video settings.
 [Custom] (→180)	This menu section is for setting camera operations, such as displaying of the screen and button operations, it can be set up according to your preferences.
 [Setup] (→195)	This menu section is for setting the clock, selecting the operating beep tone settings and other settings which make it easier for you to operate the camera. You can also configure the settings of Wi-Fi/Bluetooth related functions.
 [My Menu] (→204)	This menu section is for registering frequently-used menu items.
 [Playback] (→205)	This menu section is for the playback and editing settings for images.

- The [Setup] menu contains some important settings relating to the camera's clock and power use. Check the settings of this menu section before proceeding to use the camera.

4 Press [MENU/SET].

Touch operation

Touch a menu selector icon, such as [📷].

5 Press ▲/▼ to select the menu item and then [MENU/SET].



Touch operation

Touch the menu item.

- You can switch the page by touching the bar (A) on the right side of the screen.

6 Press ▲/▼ to select the setting and then [MENU/SET].

- Depending on the menu item, its setting may not appear or it may be displayed in a different way.

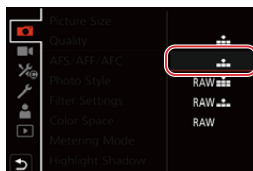

Touch operation

Touch the Setting to set.

- You can also rotate the control dial to select the menu selector icon, menu item, or setting.

■ Close the menu

Press [DISP] or the shutter button halfway.

Touch operation

Touch [DISP].



- Press [DISP] to display the menu description.
- Menu items that are not available are displayed in gray. If you press [MENU/SET] while a gray item is selected, the reason why it cannot be set is displayed in some setting situations.



Quick Menu

- 1 Press [QM] to display the Quick Menu.
- 2 Turn the control dial to select the item, and press ▼ or ▲.
- 3 Rotate the control dial to select the setting.
- 4 Press [QM] to exit the Quick Menu once the setting is complete.

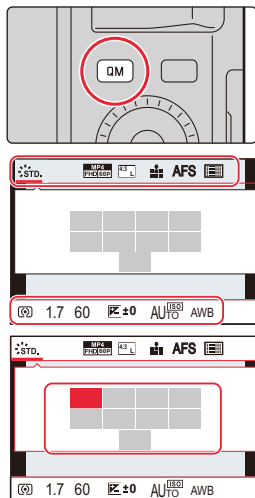

• You can also press ◀/▶ to select the item or setting.

• The features that can be adjusted using Quick Menu are determined by the mode or a display style the camera is in.

When using the on-monitor recording information screen (→40)

- 1 Press [QM].
- 2 Rotate the control dial to select the item and then press [MENU/SET].
- 3 Rotate the control dial to select the setting.
- 4 Press [QM] to finish.

• You can also set with ▲/▼/◀/▶ and [MENU/SET].

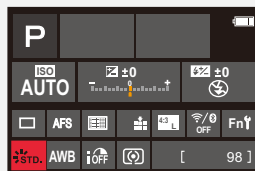

Assigning Frequently-Used Functions to Function Buttons

1 Select the menu item.

MENU → [Custom] → [Operation] → [Fn Button Set] →
[Setting in REC mode]/[Setting in PLAY mode]

2 Press ▲/▼ to select the function button you want to assign a function to and then [MENU/SET].

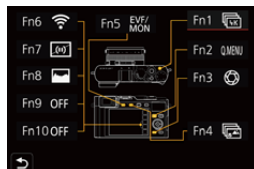

3 Press ▲/▼ to select the function you want to assign and then [MENU/SET].

- For details on the functions that can be assigned in [Setting in REC mode], refer to (→50).
- For details on the functions that can be assigned in [Setting in PLAY mode], refer to (→52).
- To restore the default function button settings, select [Restore to Default].

■ Setting function buttons from the on-monitor recording information screen

You can also display the screen in step 2 by touching [Fn] on the on-monitor recording information screen (→40).

■ Assigning functions quickly

You can display the screen in step 3 by pressing and holding a function button ([Fn1] to [Fn5]) (2 seconds).

- Some functions may not be available depending on the mode or the displayed screen.
- Some functions cannot be assigned depending on the function button.

Using the function buttons during recording

Press the function button to use the assigned function.

■ Using function buttons with touch operations

- 1 Touch .
- 2 Touch [Fn6], [Fn7], [Fn8], [Fn9] or [Fn10].



■ Functions that can be assigned in [Setting in REC mode]

– [4K Photo Mode] (→100)	– [Quality] (→168)	– [Utilize Custom Set feature] (→70)
– [Post Focus] (→110)	– [AFS/AFF/AFC] (→74)	– [Silent Mode] (→175)
– [Exposure Comp.] (→90)	– [Metering Mode] (→171)	– [Peaking] (→188)
– [Wi-Fi] (→223)	– [Bracket] (→129)	– [Histogram] (→188)
– [Q.MENU] (→47)	– [Highlight Shadow] (→172)	– [Guide Line] (→189)
– [Video Record] (→152)	– [i.Dynamic] (→173)	– [Zebra Pattern] (→190)
– [EVF/Monitor Switch] (→34)	– [i.Resolution] (→173)	– [Monochrome Live View] (→187)
– [EVF/Monitor Disp. Style] (→40)	– [Min. Shtr Speed] (→174)	– [Constant Preview] (→187)
– [AF/AE LOCK] (→89)	– [HDR] (→177)	– [Live View Boost] (→187)
– [AF-ON] (→89)	– [Shutter Type] (→176)	– [Rec Area] (→191)
– [Preview] (→69)	– [Flash Mode] (→149)	– [Zoom lever] (→186)
– [Touch AE] (→44)	– [Flash Adjust.] (→151)	– [Sensitivity] (→92)
– [Level Gauge] (→41)	– [i.Zoom] (→142)	– [White Balance] (→94)
– [Focus Area Set]	– [Digital Zoom] (→143)	– [AF Mode/MF] (→75)
– [Operation Lock]	– [Stabilizer] (→139)	– [Drive Mode] (→97)
– [Photo Style] (→169)	– [Motion Pic. Rec Quality] (→154)	– [Rec / Playback Switch]
– [Filter Effect] (→122)	– [Picture Mode in Rec.] (→156)	– [Restore to Default]
– [Picture Size] (→167)	– [Sound Rec Level Adj.] (→157)	

• Function button settings at the time of purchase.

Fn1	[4K Photo Mode]
Fn2	[Q.MENU]
Fn3	[Preview]
Fn4	[Post Focus]
Fn5	[EVF/Monitor Switch]

Fn6	[Wi-Fi]
Fn7	[Level Gauge]
Fn8	[Histogram]
Fn9	No function
Fn10	

- With [Video Record], you can start/stop recording a motion picture in the same way as with the video button.
- When set to [Focus Area Set], it is possible to display the position setting screen of either AF area or MF Assist.
- When [Operation Lock] is set, a certain type of operation is disabled. Set the type of operation to be disabled in [Operation Lock Setting] in the [Custom] ([Operation]) menu. (→185)
- If you assign [Rec / Playback Switch], you can switch between recording and playback modes.
- If the screen displays **A** or similar, the displayed operation will be performed instead of the function assigned to that function button by [Fn Button Set].



Using the function buttons during playback

You can use an assigned function by pressing the appropriate function button.

- Depending on the function, you can directly use it for the image being played back.

Example: When [Fn2] is set to [Rating★3]

- 1 Press ◀▶ to select the image.
- 2 Press [QM] / ([Fn2]), and then set the image as [Rating★3].



■ Functions that can be assigned in [Setting in PLAY mode]

- The following functions can be assigned to the buttons [Fn1], [Fn2], [Fn4] or [Fn5].

<ul style="list-style-type: none"> - [Wi-Fi] (→223) - [EVF/Monitor Switch] (→34) - [Rec / Playback Switch] - [4K PHOTO Play] - [Delete Single] (→165) - [Protect] (→208) - [Rating★1] (→208) - [Rating★2] (→208) 	<ul style="list-style-type: none"> - [Rating★3] (→208) - [Rating★4] (→208) - [Rating★5] (→208) - [RAW Processing] (→210) - [4K PHOTO Bulk Saving] (→212) - [Restore to Default]
--	---

- Function button settings at the time of purchase.

Fn1	[Wi-Fi]	Fn4	No function
Fn2	[Rating★3]	Fn5	[EVF/Monitor Switch]

- If you assign [4K PHOTO Play], a screen will be displayed, allowing you to select the pictures to be extracted from a 4K picture series file and saved.

Changing Settings using the Control Ring

You can use the control ring to change settings.

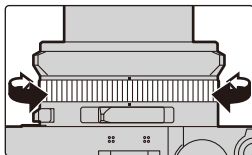

The functions that can be set with the control ring vary depending on the exposure control mode.

Listed below are the default ([Normal]) settings.

Exposure control mode	Setting
A Snapshot mode	Step Zoom (→144)
A+ Snapshot Plus mode	
P Program mode	
A Aperture-Priority mode	
S Shutter-Priority mode	Shutter speed adjustment* (→65, 66)
M Manual Exposure mode	

* You can set shutter speeds that are not indicated on the shutter speed dial. (→67)

- Rotating the control ring during panorama recording will change the selected image effect (filter). (→118)
- Rotating the control ring during manual focusing will adjust the focus setting. (→87)
- The control ring can be used to change to your preferred settings. (→54)

Changing the function assigned to the Control Ring

1 Set the menu item.

MENU →  **[Custom]** →  **[Operation]** → **[Control Ring]**

2 Use ▲/▼ to select the setting and press **[MENU/SET]**.

- You can assign the following functions:

– [Normal] (→53)	– [Photo Style] (→169)
– [Zoom] (→35)	– [Filter Effect] (→122)
– [Step Zoom] (→144)	– [Highlight Shadow] (→172)
– [Exposure Comp.] (→90)	– [i.Dynamic] (→173)
– [Sensitivity] (→92)	– [i.Resolution] (→173)
– [White Balance] (→94)	– [Flash Mode] (→149)
– [AF Mode] (→72)	– [Flash Adjust.] (→151)
– [Drive Mode] (→97)	

- To return to the default setting, select [Normal].
- If you do not want to use the control ring, select [OFF] ([Not Set]).

- The assigned function setting will be applied to all exposure control modes.
- Some functions may not be available depending on the mode or the displayed screen.

Entering Text

Follow the steps below when the text entry screen is displayed.

1 Press ▲/▼/◀/▶ to select a character and then [MENU/SET] to set.



- To enter the same character again, perform either of the following operations to move the cursor.
 - Rotate the control dial to the right.
 - Rotate the zoom lever to the [T] side.
- Operations when the items below are selected
 - [A/a]: Switch between [A] (upper case characters), [a] (lower case characters), [1] (numbers), and [&] (special characters)^{*1}
 - []: Enter a blank
 - [Delete]: Delete a character
 - [<]: Move the entry position cursor to the left^{*2}
 - [>]: Move the entry position cursor to the right^{*2}

*1 You can also switch between character modes by pressing [DISP].

*2 You can also move the entry position with the zoom lever or control dial.

- A maximum of 30 characters can be entered.
(Maximum of 9 characters when setting names in [Face Recog.])
- A maximum of 15 characters can be entered for [\], [[], []], [•] and [-].
(Maximum of 6 characters when setting names in [Face Recog.])

2 Press ▲/▼/◀/▶ to select [Set], and then [MENU/SET] to end the entry.

3.

Exposure Control Modes

The Snapshot Modes

Modes: 

These modes are recommended for those who prefer a point and shoot style, while relying on the camera to automatically select settings to match the subject and recording environment.

1 Press [A].

- The camera switches to Snapshot modes.
- When you press [A] again, the exposure control mode is switched to one set using the aperture ring and shutter speed dial (described on previous page).
- At the time of purchase, the mode is set to Snapshot Plus Mode.

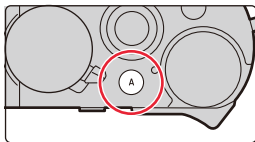

2 Point the camera at the subject.

- When the camera identifies the optimum scene mode, the respective icon will be displayed. (Automatic Scene Detection)



The camera detects scenes automatically (Scene Detection)

(📷: When taking pictures, 📹: When recording videos)



[i-Portrait]



[i-Scenery]



[i-Macro]



[i-Night Portrait]^{*1}

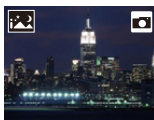

[i-Night Scenery]



[iHandheld Night Shot]^{*2}



[i-Food]



[i-Baby]^{*3}



[i-Sunset]



[i-Low Light]

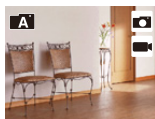

[A]

*1 Displayed when an external flash is used.

*2 Only displayed when [iHandheld Night Shot] is set to [ON].

*3 Displayed when children under 3 years old registered in the camera with the Face Recognition function are detected.

- [A] is set if none of the scenes are applicable, and the standard settings are set.

- When recording is performed with the 4K Photo or Post Focus function, Scene Detection works in the same way as when motion picture is recorded.

■ Switching between Snapshot Plus Mode and Snapshot Mode

1 Select the menu item.

MENU → [A] [A+] [Snapshot Mode] → [Snapshot Mode]



2 Press ▲/▼ to select [A+] or [A] and then [MENU/SET].



It is also possible to display the selection screen by touching the Recording Mode icon in recording screen.







Snapshot Plus mode allows you to adjust more settings yourself (see below) as opposed to Snapshot mode.

	 Snapshot Plus mode	 Snapshot mode
Setting the brightness	○	—
Setting the color tone	○	—
Defocus Control	○	—
Menu items that can be set	Many	Few





■ Autofocus, Face/Eye Detection, and Face Recognition

The Autofocus mode is automatically set to []. If you touch the subject, the AF tracking function will work.





- The AF tracking function will also work if you press [] and then the shutter button halfway.
- When [Face Recog.] is set to [ON], and a face similar to the registered one is detected, [R] is displayed in the top right of [], [] and [].



■ About flash photography

When using the flash unit included in the scope of delivery, the camera automatically selects [], [], [] or [] according to the type and brightness of the subject.

• Refer to (→146) for details about using external flash units.

- When [] or [] is set, Red-Eye Removal is enabled.
- The shutter speed will be slower during [] or [].

■ Scene Detection

- Use a tripod or similar support when the scene detection has been identified as [].
When the camera has judged that camera shake is minimal, the shutter speed becomes slower than normal.
Take care not to move the camera while taking pictures.
- Depending on recording conditions, different scene types may be selected for the same subject.



The Backlight Compensation

When there is a backlight situation in which the main subject would appear darker, the camera will automatically attempt to correct it by increasing the brightness of the picture.

Backlight Compensation works automatically in Snapshot Plus and Snapshot modes.

[Snapshot Mode] menu

Taking handheld shots of night scenes ([iHandheld Night Shot])

When [iHandheld Night Shot] is detected while taking handheld night shots, pictures of the night scenery will be taken at a high frame rate and composed into a single picture.

MENU → **A** **A+** **[Snapshot Mode]** → **[iHandheld Night Shot]** → **[ON]/[OFF]**

- The captured image area will be slightly smaller.
- Do not move the camera during the continuous shooting after pressing the shutter button.
- Flash is fixed to [🚫] ([Forced Flash Off]).

Combining pictures into a single picture with rich gradation ([iHDR])

When there is, for example, strong contrast between the background and the subject, multiple pictures are recorded with differing exposures and combined to create a single picture rich in gradation.

[iHDR] works automatically as needed. When it does, [HDR] is displayed on the screen.

MENU → **A** **A+** **[Snapshot Mode]** → **[iHDR]** → **[ON]/[OFF]**

- The captured image area will be slightly smaller.
- Do not move the camera during the continuous shooting after pressing the shutter button.
- You cannot take the next picture until the combination of pictures is complete.
- A moving subject may be recorded with unnatural blurs.



Not available in these cases:

- [iHandheld Night Shot]/[iHDR] do not work for the pictures taken during a motion picture recording.
- [iHandheld Night Shot]/[iHDR] are not available in the following cases:
 - When recording in Continuous Mode
 - When [Quality] is set to [RAW₁], [RAW₂] or [RAW]
 - When using [Time Lapse Shot]
 - When recording 4K pictures
 - When recording with the Post Focus function
 - When recording with the Bracket function
 - When using [Stop Motion Animation] (only when [Auto Shooting] is set)
- [iHDR] is not available in the following case:
 - When recording using the flash

Taking pictures with customized color, defocus control, and brightness settings





Mode: 

■ Setting color

- 1 Press [WB] (▶).
- 2 Rotate the control dial to adjust color.
 - To return to the recording screen, press [MENU/SET].
 - The color setting will return to the default level (center point) when the camera is turned off or the camera is switched to another exposure control mode.



■ Taking a picture with a blurred background (Defocus Control)

- 1 Press [ / ] / ([Fn3]) to display the setting screen.
- 2 Set the blurriness by rotating the control dial.
 - To return to the recording screen, press [MENU/SET].
 - To cancel the setting, press [ / ] / ([Fn3]).
 - Autofocus mode is set to [].





The position of the AF area can be determined by touching the screen at the desired subject area. (Its size cannot be changed)



■ Setting brightness

- You can rotate the exposure compensation dial to adjust the brightness. (→90)

To change the settings by using the monitor screen

- 1 Touch [].
- 2 Touch the item you want to set.
 - []: Color tone
 - []: Defocus control
 - []: Brightness*

* Displayed when [Exposure Comp.] is set in a function button. (→49)
- 3 Drag the slide bar to set.
 - To return to the recording screen, press [MENU/SET].



Program Mode

Mode: **P**

The camera automatically sets the shutter speed and the aperture value according to the brightness of the subject.

You can change various settings in the [Rec] menu.

1 Turn the aperture ring to select [A] (AUTO).

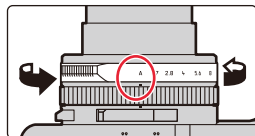

2 Turn the shutter speed dial to select [A] (AUTO).

- Program mode is set and the recording mode icon changes to [P].

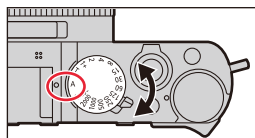

3 Press the shutter button halfway to display the aperture value and shutter speed value on the screen.

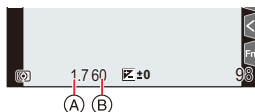

- (A) Aperture value
- (B) Shutter speed

- If the exposure is not adequate, the aperture value and shutter speed turn red and flash.

Changing the aperture value and shutter speed combination

■ Program Shift

Even in Program mode, you can change the aperture value and shutter speed combination to achieve the desired effects while maintaining the same exposure. This function is called “Program Shift”.

It enables you to, for example, reduce the area rendered sharply by decreasing the aperture value or capture a moving subject more dynamically by slowing the shutter speed.

1 While the numeric values are displayed (approximately 10 seconds), turn the control dial to change the value combinations.

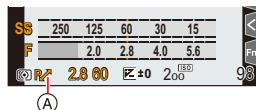

Ⓐ Program Shift indication

- To cancel Program Shift, perform either of the following operations:
 - Set the camera on/off switch to [OFF].
 - Rotate the control dial until the Program Shift indication disappears.
- To compensate the exposure, adjust it with the exposure compensation dial. (→90)

Ⓢ Not available in these cases:

- Program Shift is not available in the following cases:
 - When recording using flash
 - When recording 4K pictures
 - When recording with the Post Focus function
 - When the ISO sensitivity is set to [ISO]

Setting Aperture and/or Shutter Speed



Modes: **A** **S** **M**

You can set the exposure using the aperture ring and/or shutter speed dial.

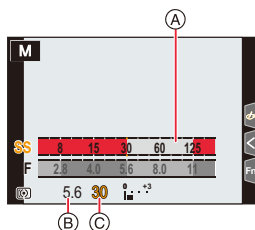
(Example: In Manual Exposure mode)

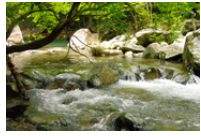

- (A) Exposure setting balance
- (B) Aperture value
- (C) Shutter speed

<p>Aperture value</p>	 <p>Smaller The area rendered sharply is reduced.</p>	 <p>Larger The area rendered sharply is expanded.</p>
<p>Shutter speed</p>	 <p>Slower Moving subjects are rendered increasingly blurred.</p>	 <p>Faster Moving subjects are rendered increasingly sharp.</p>

- The effects of the set aperture value and shutter speed are not visible on the monitor image. To check the effects, please use [Preview]. (→69)
- The brightness of the screen and the recorded pictures may differ. Check the pictures on the playback screen.
- When you turn the aperture ring or shutter speed dial, an exposure setting balance is displayed. Unsuitable areas of the range are displayed in red.
- If the exposure is not adequate, the aperture value and the shutter speed turn red and flash when the shutter button is pressed halfway.
- A faster shutter speed than the one set may be used when you record a video.

Aperture-Priority mode

Set the aperture value to a higher number if you want a larger in-focus area (in front of and behind the focused subject), or to a lower number for the opposite.

1 Turn the shutter speed dial to select [A] (AUTO).

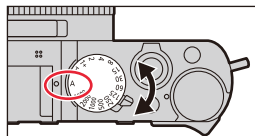

2 Turn the aperture ring to select the aperture value.

- Aperture-Priority mode is set and the recording mode icon changes to [A].
- To compensate the exposure, use the exposure compensation dial. (→90)

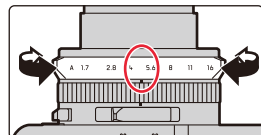

Available aperture values*	Shutter speed set
F1.7 to F16	60s to 1/4000s (When the mechanical shutter is used) 1s to 1/16000s (When the electronic shutter function is used)

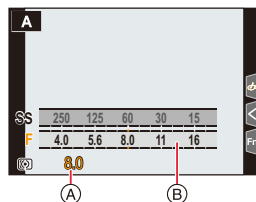

- (A) Aperture value
(B) Exposure setting balance

* You may not be able to select some values depending on the zoom lens position.

Shutter-Priority mode

Set a faster shutter speed if you want to take a sharp photo of a moving subject, or a slower speed if you want to create e.g. subject blur to emphasize a movement.

1 Turn the aperture ring to select [A] (AUTO).

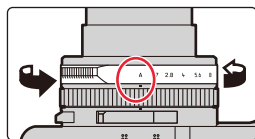

2 Turn the shutter speed dial to select the shutter speed.

- Shutter-Priority mode is set and the recording mode icon changes to [S].
- To compensate the exposure, use the exposure compensation dial. (→90)

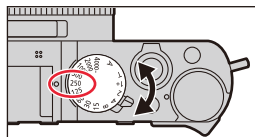

Available Shutter Speed	Aperture value set
60s to 1/4000s (When the mechanical shutter is used) 1s to 1/16000s (When the electronic shutter function is used)	F1.7 to F16

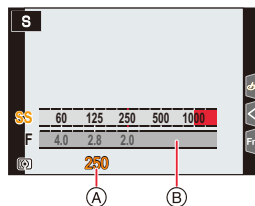

- (A) Shutter speed
- (B) Exposure setting balance

Manual Exposure mode

This mode allows you to determine the exposure by manually setting both shutter speed and aperture value. The manual exposure assistance scale appears at the bottom of the screen to indicate the over-/under-/ correct exposure resulting from the respective settings.

1 Turn the aperture ring to select the aperture value.

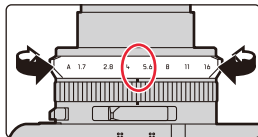

2 Turn the shutter speed dial to select the shutter speed.

- Manual Exposure mode is set and the recording mode icon changes to [M].

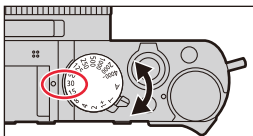

Available aperture values*1	Shutter speed set*2
F1.7 to F16	[T] (Time) 60s to 1/4000s (When the mechanical shutter is used) 1s to 1/16000s (When the electronic shutter is used)

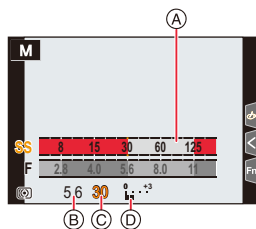

- Ⓐ Exposure setting balance
- Ⓑ Aperture value
- Ⓒ Shutter speed
- Ⓓ Manual Exposure Assistance

*1 You may not be able to select some values depending on the zoom lens position.

*2 You may not be able to select some shutter speeds depending on the aperture value.

**Setting the shutter speed to values not available on the shutter speed dial**

Turn the control ring or control dial to set the following shutter speeds. Check the shutter speed on the screen.

The available shutter speeds vary depending on the [Shutter Type] setting. Refer to (→176) for information on how to change the setting.

Higher shutter speeds than 1/4000s or slower shutter speeds than 1s

- ❶ Set the [Shutter Type] in the [Rec] menu (→176)
- ❷ Turn the shutter speed dial to select [4000–] or [1+]
- ❸ Turn the control ring or control dial to select the shutter speed

Shutter speed setting in 1/3 EV steps

- You can adjust the shutter speed set with the dial in the range of $\pm 2/3$ steps.

Example: To set the shutter speed to 1/400s

- ❶ Turn the shutter speed dial to select [500]
- ❷ Turn the control ring or control dial to select [400]

**Adjusting the ISO sensitivity based on the set shutter speed and aperture values**

When the [ISO] sensitivity is set to [AUTO], the camera sets the ISO sensitivity automatically so that the exposure will be appropriate for the set shutter speed and aperture value.

- Depending on recording conditions, an appropriate exposure may not be possible or the ISO sensitivity may become higher.

**Manual Exposure Assistance**

	The exposure is appropriate.
	Set to a faster shutter speed and/or a larger aperture value.
	Set to a slower shutter speed and/or a smaller aperture value.

- The Manual Exposure Assistance is an approximation. We recommend checking the pictures on the playback screen.

■ About [T] (Time)

When you set the shutter speed to [T] (Time), the shutter stays open when the shutter button is pressed fully (up to approximately 29 minutes).

The shutter will close when the shutter button is pressed again.

Use this function when you want to keep the shutter open for a long time to take pictures of fireworks, a night scene etc.

- It can only be used with Manual Exposure Mode.
-



- When the shutter speed is set to [T] (Time), we recommend using a tripod and releasing the shutter remotely by connecting the camera to a smartphone via Wi-Fi connection to prevent camera shake. [B] (Bulb) is also available when connected via Bluetooth. (→234, 236)
 - When you take pictures with the shutter speed set to [T] (Time), the pictures may have higher noise levels. If you want to suppress noise, we recommend setting [Long Shtr NR] to [ON] in the [Rec] menu. (→174)
-



Not available in these cases:

- When recording using flash (only when [Flash Synchro] is set to [2ND])
- When recording 4K pictures
- When recording with the Post Focus function
- When recording with the Bracket function
- When [Silent Mode] is set to [ON]
- When using the electronic shutter function
- When [HDR] is set to [ON]
- When using [Time Lapse Shot]
- When using [Stop Motion Animation] (only when [Auto Shooting] is set)

Confirming the effects of the aperture and shutter speed settings (Preview Mode)

Available in the following modes: **A** **Af** **P** **A** **S** **M**

- **To confirm the effects of the aperture setting:** You can preview the depth of field (how much of the fore- and background will be rendered sharply) before taking a picture by selecting different aperture values.
- **To confirm the effects of the shutter speed setting:** Movement can be confirmed (You can preview how sharp (unsharp) a moving subject will be rendered) by displaying the actual picture that will be taken with that shutter speed.

Press **[Fn3]** / **[Fn3]** to switch between different preview screens.

• [Preview] is assigned to [Fn3] by default. (→49)

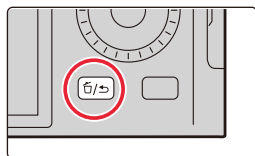

Normal recording screen



Aperture effect preview screen
Aperture effect: ON
Shutter speed effect: OFF



Shutter speed effect preview screen
Aperture effect: ON
Shutter speed effect: ON



Depth of field properties

	Aperture value	Smaller	Larger
*1	Focal length	Longer	Shorter
	Distance to the subject	Closer	Farther away
Depth of field (sharply rendered fore- and background)		Shallower*2	Deeper*3

*1 Recording conditions

*2 Example: When you want to take a picture with a blurred background etc.



*3 Example: When you want to take a picture with as much as possible of the fore- and background rendered sharply.

- It is possible to record while in Preview mode.
- Range for shutter speed effect check is 8s to 1/16000s.

 **Not available in these cases:**

- Preview mode is not available when recording with [4K Pre-Burst].

Registering your preferred settings (Custom Set)

Available in the following modes:   **P A S M**

Registering personal menu settings (Registering custom settings)

You can register up to 3 combinations of your preferred menu settings.

Preparations:

Change the settings of menus such as [Rec], [Motion Picture], and [Custom] to your preferred settings.

MENU →  **[Setup]** → **[Cust.Set Mem.]** →
Custom set where you want to register settings

- The following menu items are not registered as custom settings.

[Custom] menu	[Setup] menu
– Data registered with [Face Recog.] – The [Profile Setup] setting	[Playback] menu
	– [Rotate Disp.] – [Picture Sort] – [Delete Confirmation]

Calling up a registered set of custom settings

1 Select the menu item.

MENU →  **[Setup]** → **[Utilize Custom Set feature]**

2 Press ▲/▼ to select the custom setting you want to use, and then [MENU/SET].

- The settings are switched to those settings you selected for the custom set.



You can also display the selection screen by touching the recording mode icon on the recording screen.



■ Changing registered settings

Even if the menu settings are changed temporarily while any one of the custom settings is selected, the currently registered settings will remain unchanged.

To change the currently registered settings, overwrite the registered data using [Cust.Set Mem.] in the [Setup] menu.



Quickly calling up custom sets

Setting a function button to [Utilize Custom Set feature] allows you to switch quickly to your preferred settings by pressing that function button.

- 1 Use [Fn Button Set] in the [Custom] ([Operation]) menu to set the [Utilize Custom Set feature] in the desired function button. (→49)
 - 2 Press the function button.
 - 3 Use ◀/▶ to select custom set and press [MENU/SET].
-

4.

Focus, Exposure Compensation and Color tone Settings

Automatic Focusing

Available in the following modes: **A** **AF** **P** **A** **S** **M**

1 Move the focus mode selector switch to [AF] or [AF_{LOCK}].

- The focus mode will be set. (→74)
- Ⓐ: Align the setting with the index mark

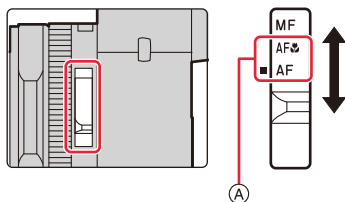

2 Press [] (◀).

3 Press ◀/▶ to select the AF mode and then [MENU/SET].

- The Autofocus mode will be set. (→75)

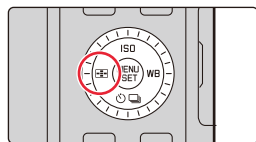

4 Press the shutter button halfway.

- Autofocus will be activated.

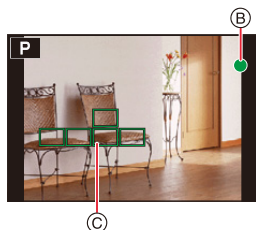

Focusing	When the subject is focused	When the subject is not focused
Focus indication Ⓑ	On	Flashes
AF area Ⓒ	Green	—
Sound	Beeps 2 times	Beeps 4 times

- The focus indication is displayed as [●_{LOW}] in a dark environment, and focusing may take longer than usual.
- If the camera detects stars in the night sky after displaying [●_{LOW}], Starlight AF will be activated. When focus is achieved, the focus indication [●_{STAR}] and AF areas in focus are displayed. (Starlight AF cannot perform detection on the edges of the image area.)

- In the Snapshot modes, the camera performs the same operation as [AF] even if you set the focus mode selector switch to [AF ] (AF Macro).
- If you zoom in/out after focusing on a subject, the focus setting may no longer be correct for that subject. In that case, re-focus.
- When the lighting is low making it difficult for Autofocus, set [Monitor Display Speed] or [EVF Display Speed] to [60fps].



Subjects and recording conditions which make it difficult for Autofocusing

- Fast-moving subjects, extremely bright subjects or subjects without contrast.
- When recording subjects through windows or near shiny objects.
- When it is dark or when the camera is not held still.
- When the camera is too close to the subject or when taking a picture of both distant and near subjects.



How to adjust the composition while maintaining the Autofocus setting

When recording with [], follow the steps below if you want to take a picture with an off-center subject. (When [AFS/AFF/AFC] is set to [AFS])

- ➊ Aim the AF area at the subject.
 - ➋ Press the shutter button halfway.
 - This will lock the focus and exposure settings.
 - ➌ While continuing to press and hold the shutter button halfway, move the camera to compose the picture you want to take.
 - ➍ Press the shutter button to take the picture.
-

Setting the focusing mode (AFS/AFF/AFC)

Available in the following modes:

Three automatic focusing modes are available.

Preparation:

Set the focus mode selector switch to [AF] or [AF].

MENU → **[Rec]/** **[Motion Picture]** → **[AFS/AFF/AFC]**

Ⓐ Align the setting with the index mark

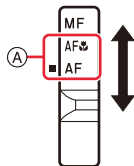

Mode	Recommended scenes	
[AFS]	The subject is still (Scenery, anniversary photograph, etc.)	“AFS” is an abbreviation of “Autofocus Single”. The focus setting stays locked while the shutter button is pressed halfway, so you can change the composition with the same focus setting. The shutter button is locked until focusing is successful.
[AFF]	The subject’s movement cannot be predicted (Children, pets, etc.)	“AFF” is an abbreviation of “Autofocus Flexible”. Whenever the subject moves while the shutter button is pressed halfway, the focus setting is readjusted automatically accordingly. The shutter can be released at any time.
[AFC]	The subject is moving (Sport, trains, etc.)	“AFC” is an abbreviation of “Autofocus Continuous”. In this mode, while the shutter button is pressed halfway, focusing is constantly performed to match the movement of the subject. The shutter can be released at any time.



When using [AFF], [AFC]

- When the subject is moving, focusing is performed by predicting the subject position at the time of recording. (Movement prediction)
- It may take time to focus on the subject when you zoom from Wide to Tele or suddenly change the subject from a distant one to a nearby one.
- Press the shutter button halfway again when it is difficult to focus on the subject.
- While the shutter button is pressed and held halfway, shake may be seen on the screen.

- In the following cases, [AFF] or [AFC] operates in the same way as [AFS]:
 - When recording with [4K Burst(S/S)]
 - In low light situations
- The Autofocus mode is fixed to [AFS] when Panorama Shot mode is set.
- [AFF] is not available when recording 4K pictures. [Continuous AF] works during recording.
- The focus mode setting cannot be changed when recording is performed with the Post Focus function.







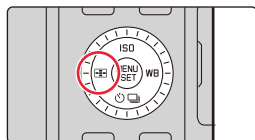

Setting the Autofocus mode

Available in the following modes: **A** **Av** **P** **A** **S** **M**

You can select the Autofocus metering method that suits the positions and number of the subjects in the picture.

Press **[]** (**◀**).



 ([Face/Eye Detection])	The camera automatically detects the faces and eyes of subjects. It sets the focus on the eye that is closer to the camera and the exposure based on the face (when [Metering Mode] is set to []). (→76)	
 ([Tracking])	The camera keeps focusing and adjusting the exposure automatically to the specified moving object. (Dynamic Tracking) (When [Metering Mode] is set to []) (→77)	
 ([49-Area])	Subjects in up to 49 AF areas can be focused. This is effective when a subject is not in the center of the screen.	
 , etc. ([Custom Multi])	You can freely combine any number of the 49 AF areas for an optimum shape of the total AF area for the subject. (→78)	
 ([1-Area])	The camera focuses on the subject in the single AF area.	
 ([Pinpoint])	You can achieve a more precise focus setting on a subject detail that is smaller than []. If you press the shutter button halfway, the monitor image will be enlarged to make it easier for you to check the focus setting.	

• In Snapshot and Snapshot Plus modes, you can select either [] or [].

About [] ([Face/Eye Detection])

When the camera detects faces, AF areas are displayed and the eye that will be focused on are indicated.

(A): Eye used for focusing

Yellow: The color changes to green when the shutter button is pressed halfway and focusing is successful.

White: This is displayed when more than one face is detected. Faces that are at the same distance as the face inside the yellow AF area will also be rendered sharply.

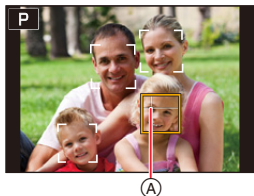

- The camera can detect the faces of up to 15 persons.
Only the eyes of a face that is focused on can be detected.

■ Changing the eye to be focused on

Touch the eye to be focused on.

- Touching [] or pressing [MENU/SET] will cancel the setting of the eye that has been focused on.

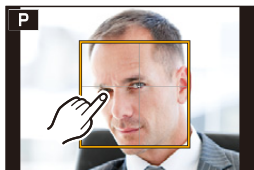

Locking the subject to be tracked ([Tracking])

Button operation

Aim the AF Tracking area/frame (B) at the subject and then press the shutter button halfway.

- The AF frame turns green when the subject is detected.
- The AF frame turns yellow when you release the shutter button.
- Press [MENU/SET] to clear the lock.

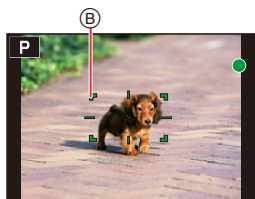

Touch operation

Touch the subject.

- Perform this operation with the Touch Shutter function canceled.
- The AF Tracking frame turns yellow while the subject is locked.
- Touch [AF OFF] to clear the lock.



- The focusing range will be the same as that of [AF Macro] (→86)
- The AF Tracking frame will flash in red and then disappear if the lock fails.

Setting the shape of an AF area group ([Custom Multi])

- 1 Press [] (◀).
- 2 Select a Custom Multi icon ([], etc.), and press ▲.
- 3 Press ◀/▶ to select a setting and then ▼.

(A) The current shape of the AF area group

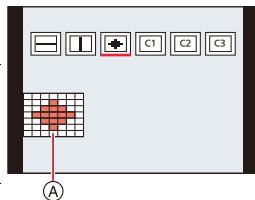

 ([Horizontal Pattern])	This shape is convenient for taking panning or similar shots.	
 ([Vertical Pattern])	This shape is convenient for recording objects, such as buildings.	
 ([Central Pattern])	This shape is convenient when you want to bring the central area into focus.	
 ([Custom1]/ [Custom2]/ [Custom3])	You can select a customized setting.	

• The AF area setting screen is displayed.

4 Select AF areas.

(B) The selected AF areas

When selecting []/[]/[]

- 1 Changing the shape of the AF area group.

Button operation	Touch operation	Description of operation
▲/▼/◀/▶	Touching	Moves the position
	Pinching out/in	Changes the size
[DISP]	[Reset]	First time: The position is reset to the center Second time: The size is reset to the default setting

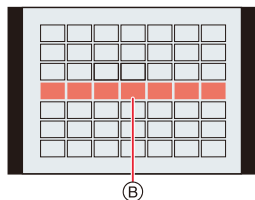

- 2 Press [MENU/SET] to set.

When selecting [C1]/[C2]/[C3]

- 1 Changing the shape of an AF area group.

Button operation

Press ▲/▼/◀/▶ to select the AF area, and then [MENU/SET] to set (repeat).

- The setting is canceled when [MENU/SET] is pressed again.
- To cancel all selections, press [DISP].

Touch operation

Touch or drag to select AF areas.

- To cancel the selection of a particular AF area, touch it again.

- 2 Press [QM] / ([Fn2]) to set.

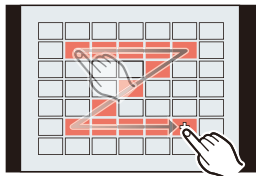

■ **Registering the set AF area group to** [C1], [C2] or [C3]

- 1 On the screen in step 3 on (→78), press ▲.
- 2 Press ▲/▼ to select to which of the custom slots the setting will be registered, and then [MENU/SET].

- Turning off the camera will return the setting adjusted with []/[]/[] back to the default setting.





Restrictions concerning Autofocus mode

- Autofocus mode cannot be set in the following case.
 - When recording with the Post Focus function
- The AF metering method is fixed to  in the following cases.
 - When using Digital Zoom
 - When using [Miniature Effect] in [Filter Settings]

([Face/Eye Detection])

- The camera may not detect faces in certain situations, such as when they are moving fast. In such situations, the camera switches to .



([Tracking])

- In situations where AF Tracking does not work correctly due to certain recording conditions, such as when the subject is small or the location is dark,  is performed.
-  cannot be used with [Time Lapse Shot].
- In the following cases,  operates as .
 - When using [Sepia]/[Monochrome]/[Dynamic Monochrome]/[Rough Monochrome]/[Silky Monochrome]/[Soft Focus]/[Star Filter]/[Sunshine] in [Filter Settings]
 - When using [Monochrome]/[Monochrome HC]/[Monochrome HC+] in [Photo Style]

([Custom Multi])

- AF areas at the center are brought into focus during 4K photo recording or video recording using [Continuous AF].

([Pinpoint])

- In the following cases,  operates as :
 - When recording videos
 - When recording 4K pictures
-  cannot be set in the following case:
 - When [AFS/AFF/AFC] in the [Rec] menu is set to [AFF]/[AFC]

Changing the position and size of the AF area

Available in the following modes: **P** **A** **S** **M**

When [], [], [] or [] in Autofocus mode are selected, you can change the position and size of the AF area. With [], you can set the lock-on position.

- Perform these operations with the touch shutter function activated.
- You can also display the AF area setting screen by touching the recording screen.

MENU → **[Custom]** → **[Operation]** → **[Touch Settings]** → **[Touch AF]** → **[AF]**

- You can use the **[Custom]** (**[Focus / Release Shutter]**) menu to set the display method for the AF area according to your preference. (→180)

- The spot metering target can also be moved to match the AF area when the exposure **[Metering Mode]** is set to [].



Not available in this case:

- When using Digital Zoom

When selecting [], [], []

- 1 Press [] (◀).
- 2 Select [], [] or [] and press ▼.
 - The AF area setting screen appears.

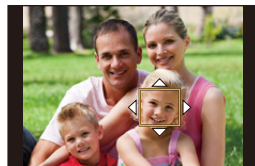

- 3 Change the position and size of the AF area.

Button operation	Touch operation	Description of operation
▲/▼/◀/▶	Touching	Moves the position
—	Pinching out/in	Changes the size (in small steps)*
	—	Changes the size*
[DISP]	[Reset]	First time: The position is reset to the center Second time: The size is reset to the default setting*

* This operation is not available for [].

- 4 Press **[MENU/SET]** to set.

- If you have selected [], an AF area with the same function as [] will be set in the set position.
- Setting of the AF area is cleared when **[MENU/SET]** is pressed or [] is touched.

When selecting [AF]

You can set the focus position by selecting an AF area group. The total AF area, which is divided into 49 boxes, is divided into groups consisting of 9 boxes each (6 or 4 boxes for the groups located at the edges of the screen).

- 1 Press [AF] (◀).
- 2 Select [AF] and press ▼.
 - The AF area setting screen appears.
- 3 Press ▲/▼/◀/▶ to select an AF area group.
- 4 Press [MENU/SET] to set.
 - Setting of the AF area is cleared when [MENU/SET] is pressed or [AF OFF] is touched.

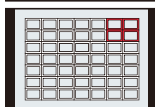
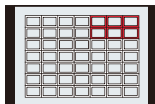
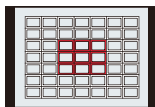

Examples of group



When selecting [+]

You can set the focusing position precisely by enlarging the monitor image.

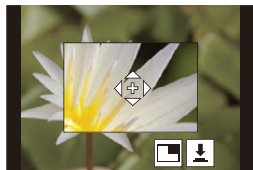
- 1 Press [] (◀).
- 2 Select [+] and press ▼.
- 3 Press ▲/▼/◀/▶ to set the focusing position and then press [MENU/SET].
 - The enlarged display appears.



- 4 Move [+] to the position to be in focus.



Button operation	Touch operation	Description of operation
▲/▼/◀/▶	Touching	Moves [+].
—	Pinching out/in	Enlarges/reduces the image in small steps.
	—	Enlarges/reduces the image.
—		Switches the enlarged display (windowed/full screen). <div style="display: flex; align-items: center; justify-content: center; margin-top: 10px;">  ↔  </div>
[DISP]	[Reset]	Returns you to the screen in step 3.

- When the picture is displayed in windowed mode, you can enlarge the picture by approximately 3× to 6×; when the picture is displayed in full screen, you can enlarge the picture by approximately 3× to 10×.
- You can also take pictures by touching [].

- 5 Press [MENU/SET] to set.



- You cannot set the focusing position at the edges of the screen.

Moving the AF area by Touch Control

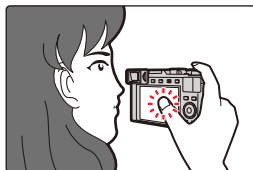

Available in the following modes:   **P** **A** **S** **M**

When you use the viewfinder, you can move the AF area by touch operations on the monitor.



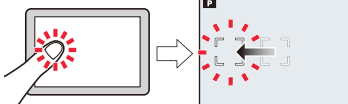
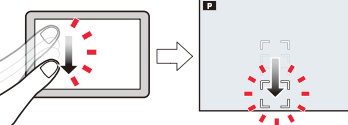



MENU →  **[Custom]** →  **[Operation]** → **[Touch Settings]** → **[Touch Pad AF]**

[EXACT]	<p>Moves the AF area by touching a desired position on the monitor.</p>	
[OFFSET]	<p>Moves the AF area according to where you drag it to on the monitor.</p>	
[OFF]	—	—

- Press the shutter button halfway to display the focusing position.
To return the focusing position to the center, press [DISP] before displaying the position.
- To cancel the AF area setting when [], [] or [] is selected, press [MENU/SET].

Optimizing brightness using Touch Control

Available in the following modes:   **P** **A** **S** **M**



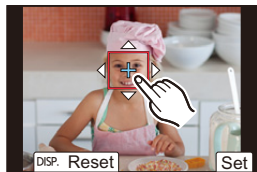

MENU →  **[Custom]** →  **[Operation]** → **[Touch Settings]** → **[Touch AF]** → **[AF+AE]**

1 Touch the subject you want to optimize the brightness for.

- The AF area setting screen appears. (→81)
- The brightness optimization position is displayed in the center of the AF area. The position follows the movement of the AF area.
- The exposure [Metering Mode] is set to , which is used exclusively for the Touch AE.



2 Touch [Set].

- The touched position will be set as an AF area with the same function as .
- To cancel the focus and brightness settings achieved with [AF+AE], touch  ( when  is selected).



When the background has become too bright, etc., the brightness contrast with the background can be adjusted by compensating the exposure.



- When recording with Touch Shutter, the focus and brightness settings are optimized for the touched position before recording takes place.
- At the edge of the screen, the metering may be affected by the brightness around the touched location.



Not available in these cases:

- The [AF+AE] function is not available in the following case:
 - When using Digital Zoom

Taking Close-up Pictures

Available in the following modes: **[A]** **[AF]** **[P]** **[A]** **[S]** **[M]**

This mode allows you to take close-up pictures of a subject, e.g. of flowers.

Move the focus mode selector switch to **[AF]**.

- You can take pictures of a subject as close as 3 cm ($1\frac{3}{16}$ "") from the lens by setting the lens' shortest focal length.
- The focusing range is displayed when you change the focal length, for example. (→36)

Ⓐ Align the setting with the index mark

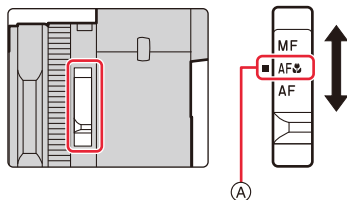

- In the Snapshot modes, the shortest focusing distance will be the same as that for **[AF]**, regardless of the focus mode selector switch setting.
- Keep the following points in mind when taking close-up pictures:
 - A picture may be out of focus when the subject is outside the setting range, even if the focus display is lit.
 - Using a tripod and [Self Timer] is recommended.
 - We recommend not to use a flash unit.
 - The effective depth of field (the area rendered sharp) is significantly smaller. Therefore, if the distance between the camera and the subject is changed after focusing on the subject, it may become difficult to focus on it again.
 - The resolution may be slightly reduced at the edges of the picture. This is not a malfunction.

Manual Focusing

Available in the following modes: **[A]** **[Av]** **[P]** **[A]** **[S]** **[M]**

Use this function when you want to determine the focus setting yourself or when the distance between the lens and the subject remains unchanged for several shots and you do not want to activate Auto focus.

1 Move the focus mode selector switch to [MF].

- (A) Align the setting with the index mark

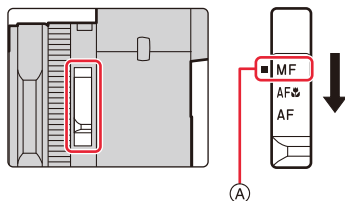

2 Press [] (◀).

3 Press ▲/▼/◀/▶ to determine the area to be enlarged, and then [MENU/SET].

- The assist screen with an enlarged section is displayed (MF Assist).
- You can also move the focus position by dragging it on the monitor.
- You can also enlarge the image by pinching out or touching the screen twice.

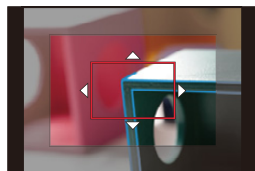

4 Turn the control ring to focus.

Clockwise:

For focusing on closer subjects

Counter-clockwise:

For focusing on more distant subjects

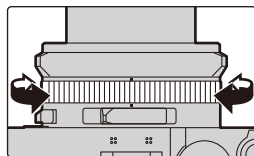

- (B) MF Assist (enlarged image)



- (C) Peaking

- (D) MF Guide

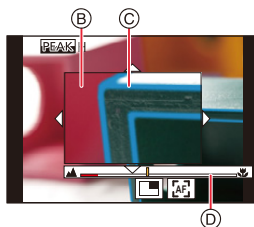
- The outlines of in-focus subjects are highlighted with color. ([Peaking])
- You can check whether the present setting is shorter or longer than for the targeted subject (MF Guide).



You can perform the following operations:

Button operation	Touch operation	Description of operation
▲/▼/◀/▶	Dragging	Moves the enlarged area.
—	Pinching out/in	Enlarges/reduces the monitor image in small steps.
	—	Enlarges/reduces the monitor image.
—	 *	Switches the enlarged display (windowed/full screen). 
[DISP]	[Reset]	The position of the enlarged area is reset to the center.

* Cannot be set in Snapshot modes.

- When the picture is displayed in windowed mode, you can enlarge it by approximately 3× to 6×; when the picture is displayed in full screen, by approximately 3× to 20×.

5 Press the shutter button halfway.

- The recording screen will be displayed.
- You can also perform the same operation by pressing [MENU/SET].

• When [Focus Switching for Vert / Hor] in the [Custom] ([Focus / Release Shutter]) menu is enabled, you can set the position of the enlarged MF Assist display for each orientation of the camera.

Using Autofocus when in Manual Focus mode

Even during manual focusing, Autofocus operation can be initiated at any time.

Touch .

- Autofocus works at the center of the frame.
- Autofocus also works with the following operations.
 - Pressing [AE/AF] when [AF-ON] is assigned to it (→89)
 - Pressing the function button to which [AF-ON] is assigned (→49)
 - Dragging and releasing your finger on the monitor at the position you want to focus on

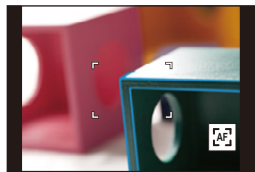

Focus and Exposure Memory Lock (AF/AE Lock)

Available in the following modes:  P A S M

This function is useful when you want to take a picture of a subject outside the AF area (AF Lock) and/or for subjects whose brightness is above or below average (AE Lock).

- 1 Aim the AF area at the subject.
- 2 Press and hold [AE/AF] to lock the focus or exposure settings.
 - If you release [AE/AF], AF/AE Lock is canceled.
- 3 While pressing [AE/AF], move the camera for your final composition and then press the shutter button fully.



■ Setting the functions of [AF/AE LOCK]

MENU →  [Custom] →  [Focus / Release Shutter] → [AF/AE Lock]

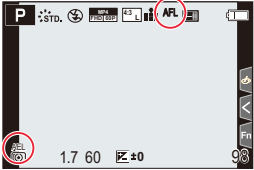
[AE LOCK]	Only the exposure setting is locked. • When the exposure is set, [AEL] is displayed.	
[AF LOCK]	Only the focus setting is locked. • When the subject is focused, [AFL] is displayed.	
[AF/AE LOCK]	Both focus and exposure settings are locked. • [AFL] and [AEL] are displayed when the focus and the exposure settings are optimized.	
[AF-ON]	Autofocus is performed.	

- AF Lock only is effective when taking pictures in manual exposure mode.
- AE Lock only is effective when taking pictures with manual focusing mode.
- Program Shift can be set even when AE is locked.

Exposure Compensation

Available in the following modes: P A S M

Use this function when you wish to modify the exposure settings the camera delivers, e.g. when your main subject would otherwise be rendered brighter/darker than you want.

Turn the exposure compensation dial to select the compensation value.

• With the exposure compensation dial, you can set a value in the -3 EV to $+3$ EV range with the dial.

- (A) Align the setting with the index mark
- (B) Exposure compensation value

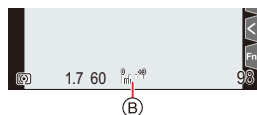
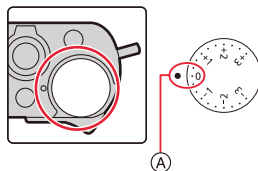

Main subject underexposed	Properly exposed	Main subject overexposed
Select a positive compensation value		Select a negative compensation value

■ Compensating the exposure over a wider range than possible with the dial

- 1 Set the menu to assign [Exposure Comp.] to a function button. (→49)
- 2 Press that function button in the recording screen.
- 3 Rotate the control dial to compensate the exposure.

- (C) Exposure compensation scale
- (D) Exposure compensation value

- When exposure is compensated with a function button, you can set a value in the -5 EV to $+5$ EV range.
- You can set Exposure Bracketing values by pressing ▲/▼. (→131)

- 4 Press [MENU/SET] to set.

- You can also press the shutter button halfway to set.

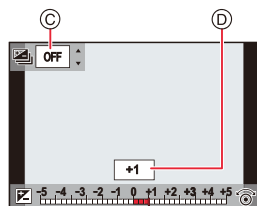

- In manual exposure mode, you can compensate the exposure only when the ISO sensitivity is set to [AUTO].
- Depending on the brightness, this may not be possible in some cases.
- When [Auto Exposure Comp.] in [Flash] in the [Rec] menu is set to [ON], the brightness of the flash illumination will automatically be set to the level appropriate to the selected exposure compensation.
(This applies if the exposure is set with a function button)
- If you assign [Exposure Comp.] to a function button, the exposure compensation dial will be disabled.
- You can set a value between -3 EV and $+3$ EV while recording motion picture or performing recording with the 4K Photo or Post Focus function.
- When the exposure compensation value is out of the -3 EV to $+3$ EV range, the brightness of the recording screen will no longer change. It is recommended to check the actual brightness of the recorded image in the Auto Review or playback screen.
- The exposure compensation value set with a function button is stored even if you set the camera on/off switch to [OFF]. (When [Exposure Comp. Reset] is set to [OFF])

Setting the ISO Sensitivity

Available in the following modes:  P A S M

This allows the sensitivity to light (ISO sensitivity) to be set. Higher values allow using faster shutter speeds e.g. for unblurred hand-held shots and/or higher aperture values e.g. for more depth of field.

1 Press [ISO] (▲).

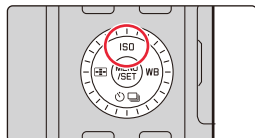

2 Select the ISO sensitivity by rotating the control dial.

▲ ISO sensitivity

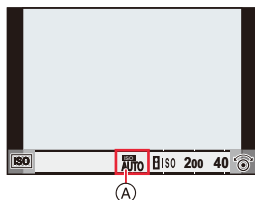

AUTO	<p>The ISO sensitivity is automatically adjusted according to the brightness.</p> <ul style="list-style-type: none"> • Up to [ISO3200]^{*1}
ISO (Intelligent ISO)	<p>The camera automatically sets the optimum ISO sensitivity and shutter speed to suit the movement of the subject and brightness of the scene to minimize subject blur.</p> <ul style="list-style-type: none"> • Up to [ISO3200]^{*1} • The shutter speed is not fixed when the shutter button is pressed halfway. It is continuously changed to match the movement of the subject until the shutter button is pressed fully.
L.100^{*2}, from 200 to 25000	<p>The ISO sensitivity is fixed to various settings.</p>

*1 When [ISO Auto Upper Limit (Photo)] in the [Rec] menu is set to [AUTO].

*2 When [Extended ISO] in the [Custom] ([Exposure]) menu is set to [ON].

3 Press [MENU/SET] to set.

- You can also press the shutter button halfway to set.

**Characteristics of the ISO sensitivity**

	200 25000	
Recording location	When it is light (outdoors)	When it is dark
Shutter speed	Slower	Faster
Noise	Less	Increased
Shaking of the subject	Increased	Less

- For details on the available flash range used when the ISO sensitivity is set to [AUTO], refer to (→147).
- Cannot be selected [ISO] in the following cases:
 - Shutter-Priority mode
 - Manual exposure mode
- Use the Quick menu (→47) to change the setting when [Direct Focus Area] (→182) is set to [ON], as the AF area is moved with the cursor buttons in this case.
- When [Multi Exp.] is set, the maximum setting is [ISO3200].
- When recording videos or recording with the 4K Photo or Post Focus function, the setting items change to the following:
 - [AUTO], [200] to [6400] ([L.100] to [6400] if [Extended ISO] is set to [ON])

Adjusting the White Balance

Available in the following modes:  P A S M

In digital photography, white balance ensures neutral, i.e. natural color reproduction in any light. White balance is based on the camera being preset to reproduce a particular color as white.



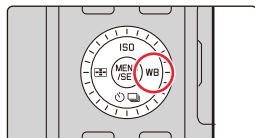

You can choose between automatic white balance, various presets, one custom setting based on specific measurements, and a direct setting of the color temperature.

1 Press [WB] (▶).

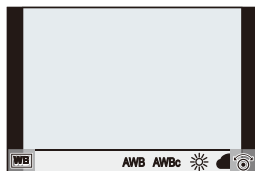



2 Rotate the control dial to select the White Balance setting.



<p>[AWB]/ [AWBc]</p>	<p>Automatic adjustment</p> <ul style="list-style-type: none"> • Under lighting such as incandescent lighting where reddish tones may occur: <ul style="list-style-type: none"> – With [AWB], reddish tones are maintained to reproduce the ambience of the scene more accurately. – With [AWBc], reddish tones are suppressed to reproduce the original colors of the subject more accurately. The same tones as [AWB] may be applied in a bright environment. • [AWB] and [AWBc] apply the same tones under light sources where reddish tones may not occur.
<p></p>	<p>When taking pictures outdoors under a clear sky</p>
<p></p>	<p>When taking pictures outdoors under a cloudy sky</p>
<p></p>	<p>When taking pictures outdoors in the shade</p>
<p></p>	<p>When taking pictures under incandescent lights</p>
<p>*</p>	<p>When taking pictures with the flash only</p>

* [AWB] is applied when you record motion picture or perform recording with the 4K Photo or Post Focus function.

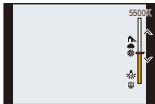
	<p>When you wish to manually meter the light and use the resulting setting, e.g. to achieve a white balance precisely matching the prevailing lighting situation.</p> <ol style="list-style-type: none"> 1 Press ▲. 2 Place a white object such as a piece of paper within the frame at the center of the screen, and press [MENU/SET]. <ul style="list-style-type: none"> • This will set the White Balance and return you to the recording screen. • White Balance may not be set when the subject is too bright or too dark. Set the White Balance again after adjusting to appropriate brightness. 	
<p>[K]</p>	<p>For using a preset color temperature setting.</p> <ol style="list-style-type: none"> 1 Press ▲. 2 Press ▲/▼ to select the color temperature and then [MENU/SET]. <ul style="list-style-type: none"> • You can set a color temperature from [2500K] to [10000K]. 	

3 Press [MENU/SET] to set.

- You can also press the shutter button halfway to set.



Under fluorescent lighting, LED lighting fixture etc., the appropriate White Balance will vary depending on the lighting type.

Use [AWB], [AWBc], [WB], [WB], [WB] or [WB].

- The White Balance may not operate correctly if you take pictures using flash and the subject is recorded outside of the effective flash range.

■ Auto White Balance

Depending on the conditions prevailing when pictures are taken, the pictures may take on a reddish or bluish tinge.

Please note that the White Balance may not work correctly in the cases below. In these cases, adjust the White Balance to anything other than [AWB] or [AWBc].

- When there are multiple light sources
- When there are no colors close to white

- 1 [AWB] will work within this range.
- 2 Blue sky
- 3 Cloudy sky (Rain)
- 4 Shade
- 5 Sunlight
- 6 White fluorescent light
- 7 Incandescent light bulb
- 8 Sunrise and sunset
- 9 Candlelight

K=Kelvin Color Temperature

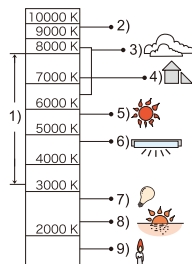

Finely adjusting the White Balance

You can finely adjust the White Balance when you cannot acquire the desired hue with the available fixed settings.

1 Select the White Balance setting and then press ▼.

2 Press ▲/▼/◀/▶ to perform White Balance fine adjustments.

- ◀ : [A] (AMBER: ORANGE)
- ▶ : [B] (BLUE: BLUISH)
- ▲ : [G] (GREEN: GREENISH)
- ▼ : [M] (MAGENTA: REDDISH)

- You can also make fine adjustments by touching the White Balance graph.
- To reset the position to the center, press [DISP].
- You can set the White Balance Bracket by rotating the control dial. (→132)

3 Press [MENU/SET].

- Press the shutter button halfway to return to the recording screen.

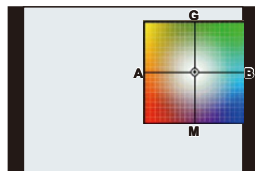

- If you finely adjust the White Balance to [A] (amber), the White Balance icon on the screen will change to orange.
If you finely adjust the White Balance to [B] (blue), the White Balance icon on the screen will change to blue.
- If you finely adjust the White Balance to [G] (green) or [M] (magenta), [+] or [-] appears beside the White Balance icon on the screen.

Selecting a Shutter Release Mode

Available in the following modes: **[A]** **[AF]** **[P]** **[A]** **[S]** **[M]**

You can change what the camera will do when you press the shutter button.

1 Press **[ ]** (**▼**).

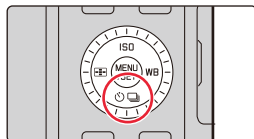

2 Press **◀/▶** to select the shutter release mode, and then **[MENU/SET]**.

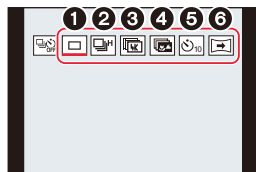

1 [Single]	When the shutter button is pressed, only one picture is taken.
2 [Burst] (→98)	Pictures are taken in succession as long as the shutter button is pressed.
3 [4K PHOTO] (→100)	When the shutter button is pressed, a 4K photo is taken.
4 [Post Focus] (→110)	When the shutter button is pressed, Post Focus recording is performed.
5 [Self Timer] (→115)	When the shutter button is pressed, the picture is taken after the set time has elapsed.
6 [Panorama Shot] (→117)	Exposures are recorded in succession while you press the shutter button and move the camera horizontally or vertically. After that the camera combines the pictures into a single panorama picture.

- Select **[ OFF]** to return to [Single] (default setting).

Using Continuous Mode

Available in the following modes: **A** **Af** **P** **A** **S** **M**

Pictures are taken in succession as long as the shutter button is pressed.

- 1 Press **[]** (**▼**).
- 2 Press **◀/▶** to select the continuous icon (**[]**, etc.), and then **▲**.
- 3 Select the frame rate with **◀/▶**, and then press **[MENU/SET]**.

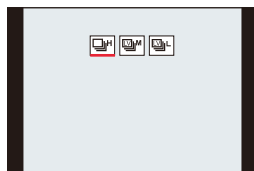
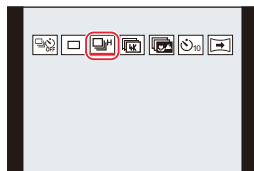

[H]	Performs high-speed serial recording.
[M]	Performs medium-speed serial recording.
[L]	Performs low-speed serial recording.

- 4 Focus on the subject and take a picture.

- Hold down the shutter button fully to activate Continuous mode.



■ Canceling Continuous mode

Select **[]** ([Single]) or **[]** from among the shutter release modes. (→97)

■ Notes on Continuous mode settings

		[H] (High speed)	[M] (Medium speed)	[L] (Low speed)
Frame rate (pictures/second)	AFS/MF	11	7	2
	AFF/AFC	5.5	5.5	
Image display during Continuous mode	AFS/MF	None	Available	Available
	AFF/AFC	Available		
Number of recordable pictures*	With RAW files	32 or more		
	Without RAW files	100 or more		

- * When recording is performed under the test conditions specified by Leica Camera AG. Pictures can be taken until the card is full. However, the frame rate will get slower halfway through the recording. The number of serial pictures is limited by the picture-taking conditions and the type and/or status of the card used.

■ About the maximum number of pictures that can be taken continuously

When you press the shutter button halfway, the maximum number of pictures you can take continuously will appear.



Example: When 20 pictures can be taken: [r20]

- Once recording starts, the maximum number of pictures that can be taken continuously decreases.
The frame rate slows down when [r0] appears.
- When [r99+] is displayed, you can take 100 or more pictures continuously.

■ Notes on focus in Continuous mode

The way the focus setting is achieved varies according to the focus mode setting and the [Focus/Release Priority] setting in the [Custom] ([Focus / Release Shutter]) menu.

AF mode settings	[Focus/Release Priority]	[H]	[M]/[L]
[AFS]	[FOCUS]	At the first picture	
	[BALANCE]		
	[RELEASE]		
[AFF]/[AFC] ^{*1}	[FOCUS]	Predicted focusing ^{*2}	Normal focusing ^{*3}
	[BALANCE]	Predicted focusing ^{*2}	
	[RELEASE]		
[MF]	—	Manual focusing	

*1 When the subject is dark, the focus setting is locked to the one set for the first picture.

*2 Frame rate takes priority, and the focus setting is estimated within the possible range.

*3 The frame rate may become slower.

- The frame rate may become slower depending on the following settings:
 - [Sensitivity]/[Picture Size]/[Quality]/[AFS/AFF/AFC]/[Focus/Release Priority]
- When the frame rate is set to [H] (when the focus setting is [AFS] or [MF]), the exposure will be set to that of the first picture. In other cases, the exposure will be adjusted for each picture.
- **It may take time to save pictures taken in Continuous mode on the card. If you take pictures continuously while saving, the maximum number of recordable pictures decreases. For continuous shooting, use of a high speed memory card is recommended.**



Continuous mode is not available in these cases:

- When using [Rough Monochrome]/[Silky Monochrome]/[Miniature Effect]/[Soft Focus]/[Star Filter]/[Sunshine] in [Filter Settings]
- When using [Multi Exp.]
- When recording with flash
- When using [Time Lapse Shot]
- When using [Stop Motion Animation] (only when [Auto Shooting] is set)

Recording 4K Pictures

Available in the following modes: **A AF P A S M**

The camera allows you to take serial pictures with a resolution of 8 million pixels (approx.) at 30 frames/second. After taking these pictures, you can save the desired moment extracted from their picture series file.

- Use a UHS Speed Class 3 card.

1 Press [] () (▼).



2 Press ◀/▶ to select a 4K picture icon (, etc.), and then ▲.

- By default, you can also perform the same operations as steps **1** and **2** by pressing [4K] / ((Fn1)).

3 Select the recording method with ◀/▶, and then [MENU/SET].

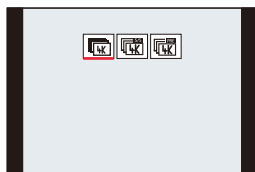
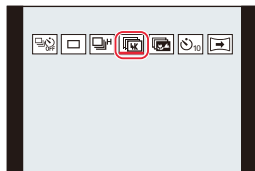
- You can also set the recording method in [4K PHOTO] in the [Rec] menu.







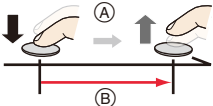

 [4K Burst]	For capturing the best shot of a fast-moving subject (e.g., sports, airplanes, trains) Audio recording: Not available
 [4K Burst(S/S)] “S/S” is an abbreviation of Start/Stop.	For capturing unpredictable photo opportunities (e.g., plants, animals, children) Audio recording: Available*
 [4K Pre-Burst]	For recording as needed whenever a photo opportunity arises (e.g., the moment when a ball is thrown) Audio recording: Not available

* Audio is not played back when you perform playback with the camera.

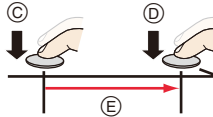
4 Record a 4K photo.

- If you are using Autofocus, [Continuous AF] will work during recording. The focus setting will be adjusted continuously.

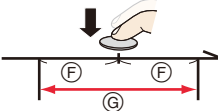
 [4K Burst]	<ol style="list-style-type: none"> Press the shutter button halfway. Press and hold the shutter button fully for as long as you want to perform recording. <ol style="list-style-type: none"> Press and hold Recording is performed <ul style="list-style-type: none"> Press the button fully slightly in advance. Recording starts approximately 0.5 seconds after it has been pressed fully. If you remove your finger from the shutter button immediately after the start of recording, up to a period of approximately 1.5 seconds after the moment that the finger has been removed may be recorded. 
 [4K Burst(S/S)]	<ol style="list-style-type: none"> Press the shutter button fully to start recording. Press the shutter button fully again to stop recording. <ol style="list-style-type: none"> Start (First) Stop (Second) Recording is performed  <p> Setting markers manually</p> <p>You can add markers if you press [QM] / ([Fn2]) during recording. (Up to 40 markers per recording) When selecting and saving pictures from a 4K picture series file, you can skip to the positions where you added markers.</p>
 [4K Pre-Burst]	<p>Press the shutter button fully.</p> <ol style="list-style-type: none"> Approximately 1 second Recording is performed <ul style="list-style-type: none"> Autofocus adjusts the focus setting continuously, and except in manual exposure mode, it also adjusts the exposure continuously. Images may not be displayed as smoothly as when recording with the normal recording screen. <p> Recording tips</p> <p>In situations where you want to lock the focus and exposure settings, such as when the subject is off-center, use [AF/AE LOCK]. (→89)</p> 





- The camera saves a 4K picture series files in the MP4 format.
- When [Auto Review] is enabled, the picture selection screen will be displayed automatically. To continue recording, press the shutter button halfway to display the recording screen.
- For information on how to select and save pictures from recorded 4K picture series files, refer to (→105).

■ Canceling 4K Picture mode

In step 2, select [] ([Single]) or [] (→100)



Battery drainage and camera temperature

- If the ambient temperature is high or 4K photo recording is performed continuously, [] may be displayed and then recording may stop. Wait until the camera cools down.
- When [] ([4K Pre-Burst]) is set, the battery drains faster and the camera temperature rises. (The setting may switch to [] ([4K Burst]) to protect the camera.) Set [] ([4K Pre-Burst]) only when recording.

Notes on the 4K Photo function

■ To change the aspect ratio

You can use the aspect ratio selector switch to select the aspect ratio of 4K pictures.

■ To record the subject with reduced blur

You can reduce the blur of the subject by setting a faster shutter speed.

1 Change the exposure control mode to [S] (Shutter-Priority mode). (→65)

2 Set the shutter speed by rotating the shutter speed dial.

- Suggested shutter speed for outdoor recording in fine weather conditions: 1/1000s or faster.
- If you increase the shutter speed, the ISO sensitivity becomes higher, which may increase the noise on the screen and the picture.

■ Preventing camera shake when taking pictures

When you perform [Light Composition] or [Sequence Composition], we recommend using a tripod and taking pictures remotely by connecting the camera to a smartphone to prevent camera shake. (→234)

■ Shutter sound for photographing

- When using [4K Burst] or [4K Pre-Burst], you can change the electronic shutter sound settings in [Shutter Vol.] and [Shutter Tone]. (→197)
- When recording with [4K Burst(S/S)], you can set the start/stop tone volume in [Beep Volume].
- High-speed serial recording can be used quietly when used in combination with [Silent Mode].

■ Unsuitable subjects

Recording in extremely bright locations or indoors

When subjects are photographed in an extremely bright place or under fluorescent/LED lighting, the color tone or brightness of the image may change, or horizontal stripes may appear on the screen.

Lowering the shutter speed may reduce the effect of the horizontal stripes.

Subjects that are moving fast

If you record a subject moving fast, it may appear distorted in the resulting picture.

■ The camera's setup for the 4K Photo function

The camera's setup is automatically optimized for 4K photo recording.



- The following [Rec] menu items are fixed to the settings below:

[Picture Size]*	[4K] (8M)	[Quality]	[
	[4:3]: 3328×2496	[Shutter Type]	[ESHTR]
	[1:1]: 2880×2880		
	[16:9]: 3840×2160		
	[3:2]: 3504×2336		

* Changes according to the aspect ratio.

- 4K picture series files are recorded with the settings indicated below:
Settings in the [Motion Picture] menu are not applied to 4K picture series files.

[Rec Quality]	[4K/100M/30p]	[Continuous AF]	[ON]
---------------	---------------	-----------------	------

- When recording with the 4K Photo function, the ranges for the following functions differ from the ones available for taking pictures in other modes:
 - Shutter speed: 1/30s to 1/16000s
 - [Min. Shtr Speed]: [1/1000] to [1/30]
 - Exposure Compensation: –3 EV to +3 EV
 - ISO sensitivity: [AUTO], [200] to [6400] ([L.100] to [6400] when [Extended ISO] is set)
- When using the 4K Photo function, the following functions are disabled:
 - Flash
 - [AF Mode] ()
 - Bracket Recording
 - [MF Assist] ([4K Pre-Burst] only)
 - Program Shift
 - White Balance ()

- The following menu items are disabled:

[Snapshot Mode]	[i]Handheld Night Shot/[i]HDR
[Rec]	[Picture Size]/[Quality]/[Color Space]/[Flash]/[Long Shtr NR]/[Shutter Type]/[Bracket]/[HDR]
[Custom]	[Rec Area]/[Face Recog.]/[Profile Setup]
[Setup]	[Economy] ([4K Pre-Burst] only)/[Monitor Display Speed]/[EVF Display Speed]

- Recording stops when the continuous recording time exceeds 15 minutes.
When using an SDHC memory card, you can continue the recording of a 4K picture series without interruption even if the file size exceeds 4 GB, but the resulting file will be divided into smaller ones for recording and playback.
With an SDXC memory card, even picture series file sizes exceeding 4 GB as a single file.
- The following changes occur when recording 4K pictures:
 - The image area used for 4K picture series is smaller than when shooting with 'normal' resolutions.
 - [Location] in [Travel Date] cannot be recorded.
 - [AFF] in [AFS/AFF/AFC] cannot be set.
 - [Simultaneous Record w/o Filter] in [Filter Settings] is not available.
 - [Step Zoom] does not work during [4K Pre-Burst] recording.
- Scene Detection in the Snapshot modes works the same way as when recording videos.
- When the shutter release mode is set to 4K Photo, it is not possible to take pictures while recording a video. (Only when [] ([Photo Priority]) is set)



Not available in these cases:

- The 4K Photo function is disabled when using the following settings:
 - When using [Rough Monochrome]/[Silky Monochrome]/[Miniature Effect]/[Soft Focus]/[Star Filter]/[Sunshine] in [Filter Settings]
 - When recording videos
 - When using [Multi Exp.]
 - When using [Time Lapse Shot]
 - When using [Stop Motion Animation]

Selecting Pictures from 4K Picture Series Files and Saving them

1 Select an image with the icon on the playback screen, and press **▲**.

- You can also perform the same operation by touching the icon .
- If the image was recorded with [4K Pre-Burst], proceed to step 3.



2 Drag the slide bar to make a rough selection of pictures.

- For information on how to use the slide view screen, refer to (→106).
- You can select scenes on the 4K serial playback screen by touching  ([4K] / ([Fn1])). (→107)

Slide view screen

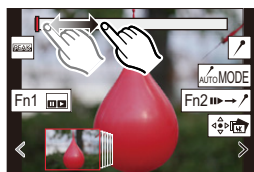

3 Drag the pictures to select the one you want to save as a picture.

- You can also perform the same operation by pressing **◀/▶**.



4 Touch to save the picture.

- The picture will be saved in JPEG format.



If you use [4K PHOTO Bulk Saving] in the [Playback] menu, you can bulk save 5 seconds' worth of 4K recording. (→212)







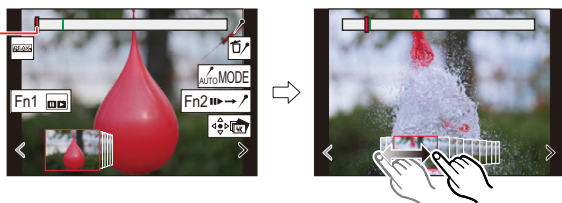

- The picture will be saved with recording information (Exif information), including its shutter speed, aperture and ISO sensitivity information.
- 4K picture series files saved on a PC will be treated as MP4 videos.

Operations during selecting pictures

■ Navigating the slide view screen

Position of the displayed frame



Button operation	Touch operation	Description of operation
◀/▶ / (⊙)	Dragging/ < / >	Selects a frame. • To change the frames displayed in slide view, select the frame at the left/right end, and touch [<] or [>].
◀/▶ Press and hold	< / > Touch and hold	Continuously rewinds/forwards frame-by-frame.
—	 Touching/ Dragging	Selects the frame to be displayed. • The previous or next frame is displayed in slide view.
	Pinching out/in	Enlarges/reduces the display.
▲/▼/◀/▶	Dragging	Moves the enlarged area (during enlarged display).
—		Switches a marker to be displayed. (→108)
[4K] / ([Fn1])		Displays the 4K serial playback screen.
[QM] / ([Fn2])		Switches to marker operation. (→108)
—	 / 	Adds/deletes a marker.
—		In-focus sections are highlighted with color. ([Peaking]) • Switches in order of [PEAK OFF] → [PEAK L] ([LOW]) → [PEAK H] ([HIGH]).
[MENU/SET]		Saves the picture

■ Navigating the 4K serial playback screen

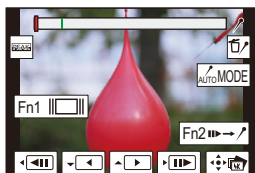

During pause



During continuous playback

Button operation	Touch operation	Description of operation
▲		Continuous playback/Pause (during continuous playback).
▼		Continuous rewind/Pause (during continuous rewind).
/		Fast forward/Picture-by-picture forward (during pause).
/		Fast rewind/Picture-by-picture rewind (during pause).
—	 Touching/ Dragging	Selects the pictures to be displayed (during pause).
	Pinching out/in	Enlarges/reduces the image (during pause).
▲/▼/◀/▶	Dragging	Moves the enlarged area (during enlarged display).
[4K] / ([Fn1])		Displays the slide view screen (during pause).
[QM] / ([Fn2])		Switches to marker operation.
—		Adds/deletes a marker.
—		The outlines of in-focus subjects are highlighted with color. ([Peaking]) • Switches in order of [PEAK OFF] → [PEAK L] ([LOW]) → [PEAK H] ([HIGH]).
[MENU/SET]		Saves the picture (during pause).

- Each time you touch the screen twice, the display switches between enlarged and normal view.

Selecting and saving pictures on the TV screen

- Set [HDMI Mode (Play)] to either [AUTO] or a setting with a resolution of [4K/30p]. When connecting to a TV that does not support 4K video, select [AUTO].
- If you display 4K picture series files on a TV connected to the camera, they will be displayed only on the 4K serial playback screen.
- Depending on the TV to be connected, 4K picture series files may not be played back correctly.

Marking Pictures from 4K Picture Series

When selecting and saving pictures from a 4K picture series file, you can select pictures easily by jumping between marked ones.

Two types of markers are available.

White marker:

This is manually set during recording or playback.

Green marker:

This is automatically set by the camera during recording. (Auto Marking function)

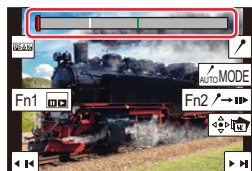

Marker operation screen

Jumping to the marked pictures

When [Fn1 / Fn2] is touched on the slide view screen or 4K serial playback screen, the marker operation screen appears and you can jump to the marked pictures. Touch [Fn2 / Fn1] to return to the original operation.

Button operation	Touch operation	Description of operation
◀/▶	⏪ / ⏩	Moves to the previous/next marker.



Auto Marking function

The camera automatically sets markers on pictures in which a face or the movement of a subject is detected.

(Example: In a picture when a vehicle passes by, a balloon bursts, or a person turns around)

- Up to 10 markers are displayed for each file.
- In the following cases, markers may not be set by the Auto Marking function depending on the recording conditions and the status of subjects.
 - The camera is moving because of panning or shaking
 - The movement of a subject is slow/small
 - The subject is small
 - A face is not facing the camera

■ Switching a marker to be displayed

Touch **[]** on the slide view screen, 4K serial playback screen, or marker operation screen.

[Auto]	Displays a marker in a picture in which a face or the movement of a subject is detected.
[Face Priority]	Displays a marker with preference given to a picture in which a face is detected.
[Motion Priority]	Displays a marker with preference given to a picture in which the movement of a subject is detected.
[Off]	Displays manually set markers only.

- You cannot delete markers set by the Auto Marking function.
- The markers set by the Auto Marking function may not be displayed correctly if you split the 4K picture series file on another device and then play it back on the camera.
- In the following case, markers set by the Auto Marking function are not displayed.
 - 4K picture series files recorded with [4K Pre-Burst]

Selecting the Focusing Plane After Recording (Post Focus/Focus Stacking)

Available in the following modes: **A** **Af** **P** **A** **S** **M**

This mode allows you to shift the focus setting while taking 4K serial pictures. After taking these pictures, you can select the desired focused areas.

This function is only suited for recording static objects.



4K serial recording while automatically shifting the focus setting.



Touch the subject to be focused on.



A picture with the desired focus setting is made.

- Use a UHS Speed Class 3 card.
- We recommend that you use a tripod when recording images to be used for Focus Stacking.

1 Press **[]** **[]** **[]** (▼).

2 Press **◀/▶** to select the Post Focus icon (**[]**), and then **[MENU/SET]**.

- By default, you can also perform the same operations as steps 1 and 2 by pressing **[PF]** / **[(Fn4)]** and then selecting **[ON]**.

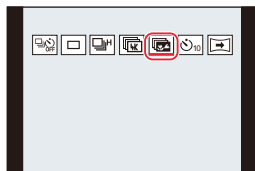

3 Decide on the composition, and press the shutter button halfway.

- Autofocus will detect the subjects within the monitor screen that can be focused on.
- If no areas on the screen can be brought into focus, the focus display (A) will flash. Recording is not possible in this case.



From the time you press the shutter button halfway until the end of recording:

- Maintain the same distance to the subject and the same composition.

4 Press the shutter button fully to start recording.

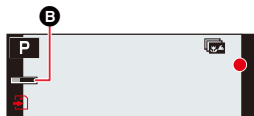

- The focus setting changes automatically while recording. When the icon (B) disappears, recording automatically ends.
- A video will be recorded in the [MP4] recording format. (Audio will not be recorded.)
- When [Auto Review] is enabled, a screen that lets you select the desired focus settings will be displayed. (→112)

■ To cancel the [Post Focus] recording In step 2, select [] ([Single]) or [] ([Off]). (→110)



About camera temperature

- When the ambient temperature is high or Post Focus recording is performed repeatedly, the camera may display [] and recording may stop. Wait until the camera cools down.

■ Limitations on the Post Focus function

- Since recording is performed in the same image quality as 4K pictures, certain limitations apply to recording functions and menu settings. For details, refer to “The camera’s setup for the 4K Photo function” on (→103).
- In addition to the limitations of the 4K Photo function, the following limitations apply to the Post Focus function:
 - Manual focus operation is disabled.
 - Autofocus mode and [AFS/AFF/AFC] are not available.
 - Videos cannot be recorded.
 - [Digital Zoom] is disabled.
 - The following [Custom] menu items are disabled: [Shutter AF]



Not available in these cases:

- The Post Focus function is disabled when using the following settings:
 - When using [Rough Monochrome]/[Silky Monochrome]/[Miniature Effect]/[Soft Focus]/[Star Filter]/[Sunshine] in [Filter Settings]
 - When [Multi Exp.] is set
 - When using [Time Lapse Shot]
 - When using [Stop Motion Animation]

Selecting the pictures with the desired focus settings and saving a picture ([Post Focus])

1 Select a picture with the [▲] [PEAK] icon on the playback screen, and press ▲.

- You can also perform the same operation by touching the icon [▲] [PEAK].



2 Touch the desired subject.

- If the selected area cannot be focused, a red frame will be displayed. You cannot save a picture in this case.
- You cannot select subjects at the edges of the screen.



Button operation	Touch operation	Description of operation
▲/▼/◀/▶/ 	Touching	Selects a focus setting. • Not possible during enlarged display.
		Enlarges the display.
		Reduces the display (during enlarged display).
[4K] / ([Fn1])		Switches to the Focus Stacking function. (→113)
[QM] / ([Fn2])		The edges of in-focus sections are highlighted with color. ([Peaking]) • Switches in order of [PEAK OFF] → [PEAK L] ([LOW]) → [PEAK H] ([HIGH]).
[MENU/SET]		Saves the picture.

- You can fine-adjust the focus setting by dragging the slide bar during enlarged display. (You can also perform the same operation by pressing ◀/▶.)



3 Touch [MENU/SET] to save the picture.

- The picture will be saved in JPEG format.



Not available in these cases:

- The Post Focus function cannot be set when the camera and a TV are connected with an HDMI micro cable.

Merging multiple pictures to expand the area rendered sharply (Focus Stacking)

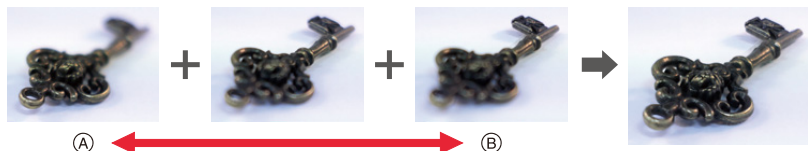

(A) Focus setting: closer

(B) Focus setting: farther away

1 Touch in step 2 of “Selecting the pictures with the desired focus settings and saving a picture ([Post Focus])” (→ 112).

- You can also perform the same operation by pressing [4K] / ([Fn1]).

2 Touch the merging method.

[Auto Merging]	Automatically selects pictures that are suited to be merged, and merges them into a single one. <ul style="list-style-type: none"> • Priority will be given to pictures with closer focus. • Perform the focus stacking and save the picture.
[Range Merging]	Merges pictures with the selected areas in focus into a single one.

(When [Range Merging] is selected)

3 Touch the desired focus area.

- Select at least two areas.
- In-focus areas between the selected two areas are indicated.
- Parts that cannot be selected are indicated in gray.

- To cancel the selection, touch the area intended to be in focus again.
- To select multiple areas, drag the screen.

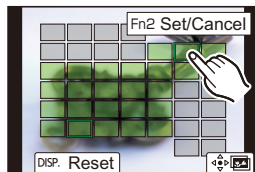
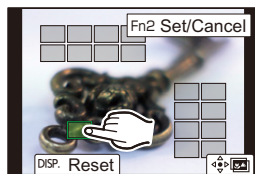

Button operation	Touch operation	Description of operation
/	Touching	Selects areas to be in focus.
[QM] / ([Fn2])	[Set/Cancel]	Specifies/cancels areas to be in focus.
[DISP]	[All]	Selects all focus areas. (Before selecting focus areas)
	[Reset]	Cancels all selections. (After selecting focus areas)
[MENU/SET]		Merges pictures and saves the resulting picture.

4 Touch [] to merge the pictures and save the resulting one.

- The picture will be saved in JPEG format. Recording information (Exif information) of the original picture with the closest focus distance, including the shutter speed, aperture, and ISO sensitivity, will also be recorded to the new picture.
- The camera can automatically correct the misalignments of pictures caused by camera shake. If they are corrected, the captured image size becomes slightly smaller when pictures are merged.
- Pictures may be merged into an unnatural-looking one in the following cases:
 - When the subject moves during recording
 - When the distance between subjects is great
 - When pictures are too defocused (If you take pictures with a larger aperture value, the resulting picture may look less unnatural.)
- You may not be able to use Focus Stacking for images recorded with other devices.

Taking Pictures with the Self-timer

Available in the following modes: **A** **Av** **P** **A** **S** **M**

1 Press **[]** (**▼**).

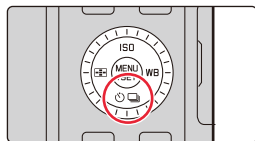

2 Press **◀/▶** to select the self-timer icon (**[10]**, etc.), and then **▲**.

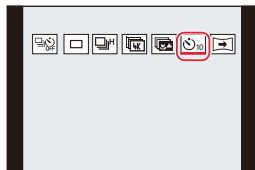

3 Press **◀/▶** to select the operation setting, and then **[MENU/SET]**.

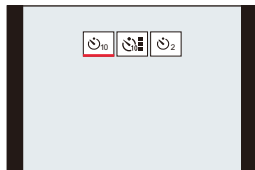

	One picture is taken 10 seconds after the shutter button is pressed.
	After 10 seconds the camera takes 3 pictures at about 2 seconds intervals.
	One picture is taken 2 seconds after the shutter button is pressed. • When using a tripod, etc., this setting is a convenient way to avoid the shaking caused by pressing the shutter button.

• Time setting for the self timer can also be set by [Self Timer] in the [Rec] menu.

4 Press the shutter button halfway to focus and then fully to take the picture.

- The focus and exposure settings will be performed when the shutter button is pressed halfway.
- After the self-timer indicator flashes, recording starts.

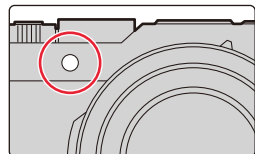

■ Canceling the self-timer

Select [] ([Single]) or [] from among the shutter release modes. (→97)

- The self-timer can also be canceled by turning off the camera. (When [Self Timer Auto Off] (→191) is set to [ON])

- We recommend using a tripod when recording with the self-timer.



Not available in these cases:

- Cannot be set to [] in the following cases:
 - When [Simultaneous Record w/o Filter] of [Filter Settings] is set to [ON]
 - When recording with the Bracket function
 - When using [Multi Exp.]
- The self-timer is disabled in the following cases.
 - When recording videos
 - When using [Time Lapse Shot]
 - When using [Stop Motion Animation] (only when [Auto Shooting] is set)

Recording panorama pictures

Available in the following modes:  P A S M

Consecutive photos taken while the camera is moved are combined to form a panorama.

1 Press [] (▼).

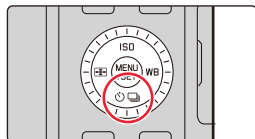



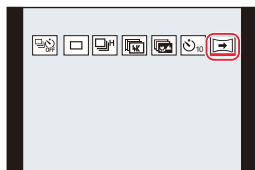

2 Press ◀/▶ to select the panorama icon ([▶]), etc.), and then ▲.

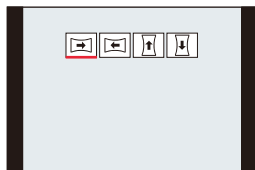

3 Press ◀/▶ to select the recording direction and then [MENU/SET].



	Left → Right	A horizontal guide line is displayed.
	Right → Left	
	Down → Up	A vertical guide line is displayed.
	Up → Down	

4 Press the shutter button halfway to focus.

5 Press the shutter button fully and move the camera in a small arc in the direction of the arrow on the screen.

Recording from left to right

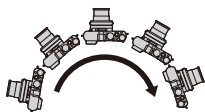

Picture size: [STANDARD]

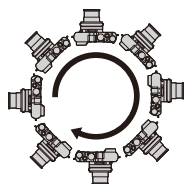

Picture size: [WIDE]



(A)

(B)

- Move the camera at a constant speed.
Pictures may not be able to be recorded properly if the camera is moved too fast or slow.

- (A) Recording direction and progress (Guide)
- (B) Horizontal/vertical guide

6 Press the shutter button again to end the picture recording.

- Recording can also be ended by stopping the camera movement while recording.
- Recording can also be ended by moving the camera to the end of the guide.



To add image effects (filters)

By default you can set the image effect by rotating the control ring.

- 1 Rotate the control ring to select the image effect.
 - 2 Press [MENU/SET].
- You can also set the effect by touching [Filter Settings] (→122) in the [Rec] menu or touching  (→128) on the touch panel.
 - Refer to (→122 to 128) for details about the adjustment and limitations of image effects.

■ Changing panorama picture settings

MENU →  **[Rec]** → **[Panorama Settings]**

[Direction]	Sets the recording direction.
[Picture Size]	Sets the angle of view (image size). [STANDARD]/[WIDE]

- The resolution in the horizontal and vertical directions of the panorama picture varies depending on the image size, the recording direction and the number of combined pictures. The maximum resolution is shown below.

Image size	Recording direction	Horizontal Resolution	Vertical Resolution
[STANDARD]	Horizontal	8176 pixels	1920 pixels
	Vertical	2560 pixels	7680 pixels
[WIDE]	Horizontal	8176 pixels	960 pixels
	Vertical	1280 pixels	7680 pixels

■ Technique for Panorama Shot mode

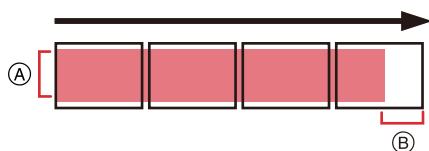

- Ⓐ Move the camera in the recording direction without shaking it. (If the camera shakes too much, pictures may not be recorded, or the created panorama picture may become narrower (smaller).)
- Ⓑ Move the camera towards the edge of the range you wish to record. (However, the last frame is not recorded to the end.)

■ About playback

Pressing ▲ will start scrolling playback automatically in the same direction as the recording.

- The following operations can be performed during scrolling playback.



		Start panorama playback/Pause*
		Stop

- * While paused, you can drag the screen to scroll forwards or backwards. If you touch the scroll bar, the playback position jumps to the touched position.

■ To cancel the panorama function

Select [] ([Single]) or [] from the shutter release mode (→97).

- The zoom lens' setting is fixed to its shortest focal length/maximum wide angle.
- The shutter type is fixed to the electronic shutter function.
- The camera automatically sets the aperture value and shutter speed during panorama recording. The settings of the aperture ring and shutter speed dial are disabled.
- The focus, White Balance, and exposure settings are fixed at the optimum values for the first picture.

As a result, if the subject's depth or brightness changes substantially during recording, the entire panorama picture may not have the suitable sharpness or brightness.

- When multiple pictures are combined to create a single panorama picture, the subject may appear distorted or the connection points may be noticeable in some cases.

Not available in these cases:

- Panorama recording is disabled in the following cases:
 - When using [Multi Exp.]
 - When using [Time Lapse Shot]
 - When using [Stop Motion Animation]
- A panorama picture may not be able to be created, or the pictures may not be combined properly when recording the following subjects or under the recording conditions below.
 - Subjects with a single, uniform color or repetitive pattern (such as the sky or a beach)
 - Moving subjects (persons, pets, cars, waves, flowers blowing in the breeze, etc.)
 - Subjects where the color or patterns change in a short time (such as an image appearing on a display)
 - Dark places
 - Locations with flickering light sources such as fluorescent lights or candles

6.

Recording Images that Suit Your Subjects and Purposes

Changing the Aspect Ratio

Available in the following modes: **A** **A+** **P** **A** **S** **M**

You can easily switch the aspect ratio of pictures using the aspect ratio selector switch.

Switching the aspect ratio selector switch

Ⓐ Align the setting with the index mark

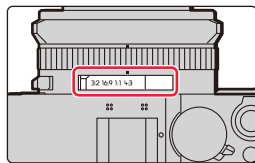

[4:3]	Aspect ratio of a 4:3 TV
[1:1]	Aspect ratio of a square image
[16:9]	Aspect ratio of high-definition TV, etc.
[3:2]	Aspect ratio of standard 35mm film cameras



Not available in these cases:

- The setting of the aspect ratio selector switch is disabled during panorama recording.

Taking Pictures with Different Image Effects (Filter)

Available in the following modes: **P** **A** **S** **M**

You can employ additional image effects even when you take panorama pictures.

1 Select the menu item.

MENU → [Rec]/ [Motion Picture] → [Filter Settings] → [Filter Effect] → [SET]

2 Press ▲/▼ to select the image effects (filters).

(A) Preview display

- You can also select the image effects (filters) by touching the example images.

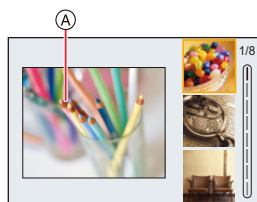

3 Press [MENU/SET].

Displaying the description of each image effect

Press **[DISP]** while the image effect selection screen is displayed.

- When it is set to the guide display, explanations for each picture effect are displayed.

Normal display

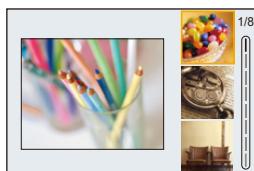

Guide display

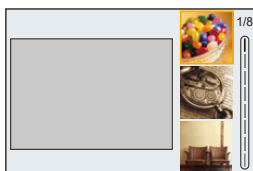

List display

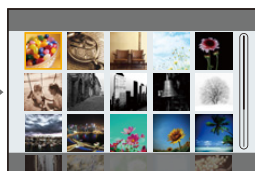

- The following items are fixed to the settings below when you set the image effect:
 - [White Balance]: [AWB]
 - [Photo Style]: [Standard]
 - [Color Space]: [sRGB]
 - [Highlight Shadow]: [Standard]
 - [i.Dynamic]: [OFF]
 - [HDR]: [OFF]
- Depending on the image effect, the recording screen may seem as if frames are missed.
- [Rough Monochrome]/[Silky Monochrome]/[Soft Focus]/[Star Filter]/[Sunshine] are not available in the following case.
 - When recording videos
- The available ISO sensitivity settings will be limited up to [ISO3200].
- The ISO sensitivity for [High Dynamic] will be fixed to [AUTO].
- The following limitations apply when Panorama Shot mode is set:
 - [Toy Effect]/[Toy Pop]/[Miniature Effect]/[Sunshine] are not available.
 - The image effects of [Rough Monochrome]/[Silky Monochrome]/[Soft Focus]/[Star Filter] will not be applied to the screen during recording.
 - When [High Key] is set, its effect may not appear clearly in scenes that are not bright enough.

Types of image effects



[Expressive]



[Retro]



[Old Days]



[High Key]



[Low Key]



[Sepia]



[Monochrome]

[Dynamic
Monochrome][Rough
Monochrome][Silky
Monochrome]

[Impressive Art]



[High Dynamic]



[Cross Process]



[Toy Effect]



[Toy Pop]



[Bleach Bypass]



[Miniature Effect]



[Soft Focus]



[Fantasy]



[Star Filter]





[One Point Color]



[Sunshine]



■ Setting the type of defocus ([Miniature Effect])

- 1 Touch [] and then select [].
- 2 Press ▲/▼ or ◀/▶ to move the in-focus section.
 - You can also move the in-focus section by touching the recording screen.
 - To set the recording orientation (defocus orientation), touch [].
- 3 Rotate the control dial to change the size of the in-focus section.
 - The section can also be enlarged/reduced by pinching out/ pinching in the screen.
 - To reset the in-focus section setting to the default, press [DISP].
- 4 Press [MENU/SET] to set.



- No sound is recorded in videos.
- When a video is recorded, the finished recording will be approximately 1/10th of the actual recorded time period. (e.g. in case of an 10-minute recording, the resulting video will be approximately 1 minute long.) The recordable time displayed on the camera is approx. 10 times of the actual recording time.
Depending on the recording frame rate of the video, its recording time and the available recording time may differ from the values above.
- If you end video recording after a short time, the camera may go on recording for a certain period.







■ Set the color to leave in ([One Point Color])

- 1 Touch [] and then select [].
- 2 Select the color you want to leave by moving the frame with ▲/▼/◀/▶.
 - You can also select the color you want to leave by touching the screen.
 - To return the frame back to the center, press [DISP].
- 3 Press [MENU/SET] to set.



- Depending on the subject, the set color may not be left in.

■ Setting the position and size of the light source ([Sunshine])

- 1 Touch  and then select .
- 2 Press /// to move the center position of the light source.
 - The position of the light source can also be moved by touching the screen.

**Tip on positioning the center of the light source**

A more natural appearance can be created by placing the center of the light source outside the image.



- 3 Adjust the size of the light source by rotating the control dial.
 - The display can also be enlarged/reduced by pinching out/pinching in.
 - To reset the light source setting to the default, press [DISP].
- 4 Press [MENU/SET] to set.

Adjusting the effect to fit your preferences

- 1 Press .
- 2 Rotate the control dial to adjust the setting.
 - Press [MENU/SET] to return to the recording screen.

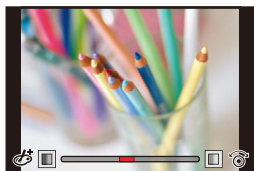













Image effect	Items that can be set		
[Expressive]	Freshness	Understated colors 	Pop colors
[Retro]	Color	Yellowish tinge 	Reddish tinge
[Old Days]	Contrast	Lower 	Higher
[High Key]	Color	Pinkish tinge 	Aquamarinish tinge
[Low Key]	Color	Reddish tinge 	Bluish tinge
[Sepia]	Contrast	Lower 	Higher

6. Recording Images that Suit Your Subjects and Purposes

Image effect	Items that can be set		
[Monochrome]	Color	Yellowish tinge	↔ Bluish tinge
[Dynamic Monochrome]	Contrast	Low contrast	↔ High contrast
[Rough Monochrome]	Grittiness	Less gritty	↔ Grittier
[Silky Monochrome]	Extent of defocus	Weaker defocus	↔ Stronger defocus
[Impressive Art]	Freshness	Black and white	↔ Pop colors
[High Dynamic]	Freshness	Black and white	↔ Pop colors
[Cross Process]	Color	Greenish tinge/Bluish tinge/Yellowish tinge/Reddish tinge	
[Toy Effect]	Color	Orangish tinge	↔ Bluish tinge
[Toy Pop]	Area with reduced peripheral brightness	Smaller	↔ Larger
[Bleach Bypass]	Contrast	Low contrast	↔ High contrast
[Miniature Effect]	Freshness	Understated colors	↔ Pop colors
[Soft Focus]	Extent of defocus	Weaker defocus	↔ Stronger defocus
[Fantasy]	Freshness	Understated colors	↔ Pop colors
[Star Filter]		Length of the rays of light Shorter ↔ Longer	
		Number of the rays of light Smaller ↔ Larger	
		Angle of the rays of light Rotate to the left ↔ Rotate to the right	
[One Point Color]	Amount of color left	Smaller amount of color	↔ Larger amount of color
[Sunshine]	Color	Yellowish tinge/Reddish tinge/Bluish tinge/Whitish tinge	

Changing the settings by using the monitor screen

- ❶ Touch [].
- ❷ Touch the item you want to set.
 - []: Image effect ON/OFF
 - [EXPS]: Selects an image effect (filter)
 - []: Adjusts an image effect
- ❸ Drag the slide bar to adjust the setting.
 - Press [MENU/SET] to return to the recording screen.



Taking a picture with and without an image effect simultaneously ([Simultaneous Record w/o Filter])

You can press the shutter button once and take two pictures simultaneously, one with an image effect and the other one without it.



MENU →  **[Rec]** → **[Filter Settings]** → **[Simultaneous Record w/o Filter]**

Settings: [ON]/[OFF]

- A picture with an image effect will be taken first, followed by one without it.
- Only an image with an image effect is displayed for Auto Review.



Not available in these cases:







- In the following cases, [Simultaneous Record w/o Filter] does not work:
 - Recording pictures while recording a video
 - When recording 4K pictures
 - When recording with the Post Focus function
 - When recording in Continuous mode
 - When using [Panorama Shot]
 - When [Quality] is set to [RAW ], [RAW ] or [RAW]
 - When recording with the Bracket function
 - When using [Time Lapse Shot]
 - When using [Stop Motion Animation]

Taking Picture Series with Automatically Changing Settings (Bracket Recording)

Available in the following modes:  P A S M

You can create a series of pictures in which a range of preset setting changes is applied automatically after pressing the shutter button.

1 Select the menu item.

MENU →  [Rec] → [Bracket] → [Bracket Type]	
 Exposure Bracketing	Pressing the shutter button creates a series of pictures with differing exposure. (→131)
 Aperture Bracketing	Pressing the shutter button creates a series of pictures with differing aperture settings. (→131) • Available in Aperture-Priority mode or when the ISO sensitivity is set to [AUTO] in manual exposure mode.
FOCUS Focus Bracketing	Pressing the shutter button creates a series of pictures with differing focus settings. (→132)
WB  White Balance Bracketing	Pressing the shutter button creates a series of 3 pictures with differing White Balance settings. (→132)
 Aspect Bracketing	Pressing the shutter button creates a series of 4 pictures with differing aspect ratios (4:3, 3:2, 16:9, and 1:1). (The shutter sounds only once.) • The area recorded for each aspect ratio is displayed. 

2 Press ▲/▼ to select [More Settings] and then [MENU/SET].

- For information on [More Settings], refer to the page that describes each function. Aspect Bracket does not have [More Settings].
- Press the shutter button halfway to exit the menu.

3 Focus on the subject and take a picture.

- When Exposure Bracket is selected, the bracket display flashes until all of the pictures you have set are taken. If you change the bracket settings or turn off the camera before all of the pictures you have set are taken, the camera restarts recording from the first picture.

■ To cancel [Bracket Type]

Select [OFF] in step 1.

- The following changes occur when Aspect Bracket is set:
 - When [Picture Size] is set to [S], the setting is automatically changed to [M].
 - The same shutter speed, aperture value, focus, [Sensitivity], [Exposure Comp.] and [White Balance] settings are used for all four pictures.



Not available in these cases:

- Bracket recording is disabled in the following cases:
 - When using [Rough Monochrome]/[Silky Monochrome]/[Miniature Effect]/[Soft Focus]/[Star Filter]/[Sunshine] in [Filter Settings]
 - When recording videos
 - When recording 4K pictures
 - When recording with the Post Focus function
 - When using [Panorama Shot]
 - When using [Multi Exp.]
 - When using [Time Lapse Shot]
 - When using [Stop Motion Animation] (only when [Auto Shooting] is set)
 - When recording with the flash (except for when using White Balance Bracket or Aspect Bracket)
- White Balance Bracket is disabled in the following cases:
 - Snapshot Plus mode
 - When using [Filter Settings]
 - When recording in Continuous mode
 - When [Quality] is set to [RAW $\frac{1}{2}$], [RAW $\frac{1}{4}$] or [RAW]
- Aspect Bracket is disabled in the following cases:
 - When [Toy Effect]/[Toy Pop] in [Filter Settings] is used
 - When recording in Continuous mode
 - When [Quality] is set to [RAW $\frac{1}{2}$], [RAW $\frac{1}{4}$] or [RAW]

Exposure Bracketing

■ About [More Settings] (step 2 in (→129))

[Step]	Sets the number of pictures to be taken and the exposure bracket range. [3•1/3] (Takes three pictures with an interval of 1/3 EV) to [7•1] (Takes seven pictures with an interval of 1 EV)
[Sequence]	Sets the order in which pictures are taken.
[Single Shot Setting]*	[□]: Takes one picture each time you press the shutter button. [📷]: Takes all the pictures set to be taken when you press the shutter button once.

* Not available for serial recording. When using serial recording, if you press and hold the shutter button, recording will be performed continuously until a specified number of pictures are taken.

[Step]: [3•1/3], **[Sequence]:** [0/-/+]

1st picture



± 0 EV

2nd picture



- 1/3 EV

3rd picture



+ 1/3 EV

• When taking pictures using Exposure Bracketing after setting an Exposure Compensation value, the pictures taken are based on the selected Exposure Compensation value.

Aperture Bracketing

Available in the following modes: **[A]** **[M]**

■ About [More Settings] (step 2 in (→129))

[Image Count]	[3], [5]: Takes the specified number of pictures with different aperture values within the range based on the initial aperture value. [ALL]: Takes pictures using all aperture values.
----------------------	---

• When using serial recording, if you press and hold the shutter button, recording will be performed until a specified number of pictures are taken.

Example:

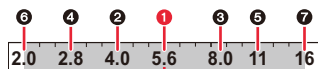

When the initial position is set to F5.6:

① first picture, ② second picture, ③ third picture... ⑦ seventh picture

Focus Bracketing

■ About [More Settings] (step 2 in (→129))

[Step]	Sets the interval between focus settings.
[Image Count]*	Sets the number of pictures to be taken.
[Sequence]	<p>[0/-/+]: Alternately moves the focus setting closer and farther away within the range centered on the initial setting as you take pictures.</p> <p>[0/+]: Moves the focus setting farther away from the initial one as you take pictures.</p>

* Not available for serial recording. When using serial recording, if you press and hold the shutter button, recording will be performed continuously until a specified number of pictures are taken.

[Sequence]: [0/-/+]



[Sequence]: [0/+]



(A) Focus: closer

(B) Focus: farther away

① first picture, ② second picture... ⑤ fifth picture...

• Pictures taken with Focus Bracketing are displayed as group images.

White Balance Bracketing

■ About [More Settings] (step 2 in (→129))

Rotate the control dial to adjust the correction range, and press [MENU/SET].





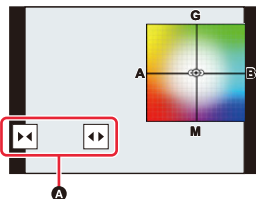

 : Horizontal ([A] to [B])

 : Vertical ([G] to [M])

• You can also set the correction range by touching .



Taking Pictures Automatically at Set Intervals ([Time Lapse Shot])

Available in the following modes:      

The camera can automatically take pictures of subjects such as animals or plants as time elapses and create a video.

- Set the date and time settings in advance. (→31)
- Recorded pictures are displayed as group pictures.

1 Select the menu item.

MENU →  **[Rec]** → **[Time Lapse Shot]**

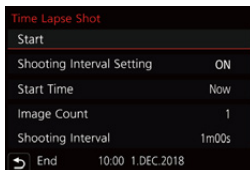

[Shooting Interval Setting]	[ON]	Sets the time from recording start time to the next recording start time.
	[OFF]	After recording is finished, the next recording is started without any interval.
[Start Time]	[Now]	Starts the recording by fully-pressing the shutter button.
	[Start Time Set]	Any time up to 23 hours 59 minutes ahead can be set. Select the item (hour or minute) by pressing ◀/▶, set the start time by pressing ▲/▼, and then press [MENU/SET].
[Image Count]/ [Shooting Interval]*1	The number of pictures and the recording interval can be set. ◀/▶: Select the item (number of pictures/minute/second) ▲/▼: Setting [MENU/SET]: Set	

*1 Can be set only when [Shooting Interval Setting] is set to [ON].

- The estimated recording ending time is displayed on the setting screen. It is displayed under the following conditions when [Shooting Interval Setting] is set to [OFF]:
 - Recording Mode: Shutter-Priority mode or manual exposure mode
 - Focus Mode: [MF]
- The camera may not be able to record using the pre-set interval and number of pictures to be recorded or may not finish recording at the estimated recording ending time under some recording conditions.

2 Press ▲/▼ to select [Start] and then [MENU/SET].



3 Press the shutter button halfway to focus.

4 Press the shutter button fully.

- The recording starts automatically.
- During recording standby, the camera will turn off automatically if no operation is performed for a certain period. The Time Lapse series is continued even with the camera turned off. When the recording start time arrives, the camera turns on automatically.

To turn on the camera manually, press the shutter button halfway.

- Operations during recording standby (The camera is turned on)

Button operation	Touch operation	Description of operation
[4K] / ([Fn1])* ²	 * ³	Displays a selection screen that lets you pause or stop the recording
		Displays a selection screen that lets you resume or stop the recording (during pause)

*² When you record pictures by setting [Shooting Interval Setting] to [OFF], you can press [4K] / ([Fn1]) even while recording is in progress. After recording (exposure) of a picture taken at the time when you pressed [4K] / ([Fn1]) is finished, a selection screen is displayed.

*³ When you record pictures by setting [Shooting Interval Setting] to [OFF], you cannot perform touch operation.

5 Select the methods for creating a video.

- The recording format is set to [MP4].

[Rec Quality]	For setting the quality of the video.
[Frame Rate]	For setting the number of frames per second. The larger the number is, the smoother the video will look.
[Sequence]	[NORMAL]: Splices pictures together in recording order. [REVERSE]: Splices pictures together in reverse recording order.

6 Press ▲/▼ to select [OK] and then [MENU/SET].

- Videos can also be created from [Time Lapse Video] in the [Playback] menu. (→220)

- This function is not for use as a security camera.
- When the lens' zoom function is used, the camera could tilt when the lens barrel extends. Make sure to secure the camera in place with a tripod or by other means.
- [Time Lapse Shot] is paused in the following cases.
 - When the battery capacity runs out
 - When the camera on/off switch is set to [OFF]
(When [Shooting Interval] is set to 31 seconds or longer)
During [Time Lapse Shot], you can replace the battery and the card, and then restart by turning on the camera. (Note that the pictures taken after replacing the card will be saved as a separate set of group pictures.)
Set the camera on/off switch to [OFF] when replacing the battery or card.
- We recommend using Autofocus for time lapse recording in cases where a long [Shooting Interval] is set and the camera will turn off automatically between shots.
- When creating videos with a [Rec Quality] setting of [4K], recording times are limited to 29 minutes.
 - In addition, when using an SDHC memory card, you cannot create videos with a file size exceeding 4 GB.
 - When using an SDXC memory card, you can create videos with a file size exceeding 4 GB.
- A video with a [Rec Quality] setting of [FHD] or [HD] cannot be created if the recording time exceeds 29 minutes or the file size exceeds 4 GB.



Not available in these cases:

- This function is not available in the following cases:
 - When using [Panorama Shot]
 - When using [Multi Exp.]
 - When using [Stop Motion Animation]

Creating Stop Motion Pictures ([Stop Motion Animation])

Available in the following modes: **A** **A_T** **P** **A** **S** **M**

A stop video is created by splicing pictures together.

- Set the date and time settings in advance. (→31)
- Recorded pictures are displayed as group pictures.

1 Select the menu item.

MENU → **[Rec]** → **[Stop Motion Animation]**

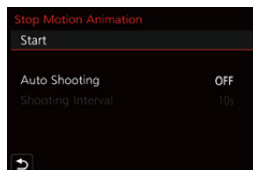

[Auto Shooting]	[ON]: Takes pictures automatically at a set recording interval.
	[OFF]: This is for taking pictures manually, frame by frame.
[Shooting Interval]	(Only when [Auto Shooting] is set to [ON]) ◀/▶ : Select the item (second) ▲/▼ : Setting [MENU/SET] : Set

2 Press **▲/▼** to select **[Start]** and then **[MENU/SET]**.

3 Press **▲/▼** to select **[New]** and then **[MENU/SET]**.

4 Press the shutter button halfway to focus.

5 Press the shutter button fully.

6 (When taking the second and subsequent pictures)

Move the subject according to the intended composition and then take the picture.



- Repeat recording for all other pictures in the same way.
- If the camera is turned off while recording, a message for resuming the recording is displayed when the camera is turned on. Selecting [Yes] allows you to continue the recording from the interruption point.
- Up to 9999 frames can be recorded.



Recording assistance

- The recording screen displays up to two pictures taken previously. Use them as reference for the amount of movement.
- To check the recorded pictures, press [▶].
Unnecessary pictures can be deleted by pressing [🗑️].
To return to the recording screen, press [▶] again.

7 Touch [👉] to end the recording.

- It can also be ended by selecting [Stop Motion Animation] from the [Rec] menu and then pressing [MENU/SET].
- When [Auto Shooting] is set to [ON], select [End] on the confirmation screen.
(If [Pause] has been selected, press the shutter button fully to resume the recording.)
- After the recording stops, a confirmation screen will be displayed, asking whether to proceed to create a video.
To create a video, select [Yes].

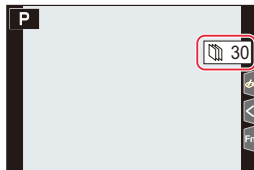

8 Select the methods for creating a video.

- The recording format is set to [MP4].

[Rec Quality]	For setting the quality of the video.
[Frame Rate]	For setting the number of frames per second. The larger the number is, the smoother the video will look.
[Sequence]	[NORMAL]: Splices pictures together in recording order. [REVERSE]: Splices pictures together in reverse recording order.

9 Press ▲/▼ to select [OK] and then [MENU/SET].

- You can also create videos using [Stop Motion Video] in the [Playback] menu. (→220)

■ Adding pictures to the Stop Motion Animation group

Selecting [Additional] in step 3 will display group pictures recorded with [Stop Motion Animation].

Select a set of group pictures, and then press [MENU/SET].



- Recording takes time under certain recording conditions, such as when flash is used. Automatic recording, as a result, may not take place at set intervals.
- When creating videos with a [Rec Quality] setting of [4K], recording times are limited to 29 minutes.
 - When using an SDHC Memory Card, you cannot create videos with a file size exceeding 4 GB.
 - When using an SDXC Memory Card, you can create videos with a file size exceeding 4 GB.
- A video with a [Rec Quality] setting of [FHD] or [HD] cannot be created if the recording time exceeds 29 minutes or the file size exceeds 4 GB.
- A picture cannot be selected from [Additional] when it is the only one that was taken.



Not available in these cases:





- This function is not available in the following cases:
 - When using [Panorama Shot]
 - When using [Multi Exp.]
 - When using [Time Lapse Shot]

Compensating Camera Shake

Available in the following modes:   **P** **A** **S** **M**

This function automatically detects and compensates camera shake.

MENU →  **[Rec]/**  **[Motion Picture]** → **[Stabilizer]**

 ([Normal])	Corrects vertical and horizontal camera shake.	
 ([Panning])	Corrects vertical camera shake. This setting is ideal for panning (technique of recording a subject by matching the camera movement with the movement of a subject going in a specific direction).	
[OFF]	[Stabilizer] does not work.	



To prevent camera shake

When the camera shake alert  appears, use **[Stabilizer]**, a tripod or the self-timer.

- The shutter speed will be slower particularly in the following cases. Keep the camera still from the moment the shutter button is pressed until the picture appears on the screen.





We recommend using a tripod.

- Slow Sync.
- Slow Sync./Red-Eye Reduction
- When you set to a slow shutter speed

- It is recommended to disable the Image Stabilizer when using a tripod.
- The stabilizer function may not be effective in the following cases:
Be careful of camera shake when you press the shutter button.
 - When there is a lot of shaking
 - When the focal length is long (Tele)
 - When using Digital Zoom
 - When taking pictures while following a moving subject
 - When the shutter speed becomes slower to take pictures indoors or in dark places
- The panning effect in [] is more difficult to achieve in the following cases.
 - In brightly lit places such as in broad daylight on a summer's day
 - When the shutter speed is faster than 1/100s
 - When you move the camera too slowly because the subject is moving slowly (The background will not become a blur)
 - When the camera does not keep up with the subject satisfactorily



Not available in these cases:

- In Panorama Shot Mode, the [Stabilizer] setting will switch to [] ([Panning]) even if it is set to [] ([Normal]).
- In the following cases, the [Stabilizer] will switch to [] ([Normal]), even if it is set to [] ([Panning]):
 - During video recording
 - When recording 4K pictures
 - When recording using [Post Focus]

Using the Lens' Zoom Function

Available in the following modes: 

Zoom types and use

■ Screen display

The illustration is an example of when using Optical Zoom, [i.Zoom], and [Digital Zoom] in Program Mode.

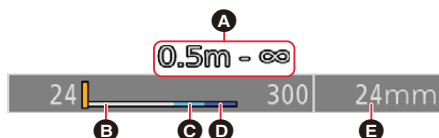

- A** Focusing range indication
- B** Optical Zoom range
- C** i.Zoom range
- D** Digital Zoom range
- E** Current zoom position (Focal lengths displayed are 35mm film camera equivalent values)

Optical zoom

You can zoom in without degrading the picture quality.

Maximum magnification: 3.1×



Not available in these cases:

- i.Zoom is not available during panorama recording.

Extra Optical Zoom

This function works when any of the resolution settings (→167) indicated with **EX** is selected.

You can zoom in further than you can with the Optical Zoom without deteriorating the image quality.

Maximum magnification: 6.2×

(This includes the optical zoom magnification. The magnification level differs depending on [Picture Size] setting.)

Not available in these cases:

- When using [Toy Effect]/[Toy Pop] in [Filter Settings]
- When recording 4K pictures
- When recording with [Post Focus]
- When using [Panorama Shot]
- When [HDR] is set to [ON]
- When using [Multi Exp.]
- When [iHandheld Night Shot] is set to [ON]
- When [iHDR] is set to [ON]
- When [Quality] is set to [RAW]
- When [Rec Area] is set to []
- When recording videos

Intelligent Zoom



You can zoom in up to twice the original zoom magnification while minimizing the deterioration of the image quality.

MENU →  **[Rec]**/ **[Motion Picture]** → **[i.Zoom]**



Settings: [ON]/[OFF]

- This function works automatically in the Snapshot modes.
- If you set the [Picture Size] to [S], you can zoom in up to 1.5× the original zoom.

Not available in these cases:

- When using [Impressive Art]/[Toy Effect]/[Toy Pop] in [Filter Settings]
- When using [Panorama Shot]
- When [HDR] is set to [ON]
- When using [Multi Exp.]
- When [iHandheld Night Shot] is set to [ON]
- When [iHDR] is set to [ON]
- When [Quality] is set to [RAW ], [RAW ] or [RAW ]

[Digital Zoom]

Available in the following modes:   **P** **A** **S** **M**

Although the image quality deteriorates every time you zoom in further, you can zoom in up to four times the original zoom magnification.

MENU →  **[Rec]/**  **[Motion Picture]** → **[Digital Zoom]**

Settings: [ON]/[OFF]

- When using the [i.Zoom], the maximum magnification of Digital Zoom is limited to 2×.
- When using Digital Zoom, we recommend using a tripod and the self-timer for taking pictures.
- In the Digital Zoom range, the AF area is displayed at the center in a larger size.

Not available in these cases:

- When **[Monitor Display Speed]** is set to **[ECO30fps]** (setting at the time of purchase)
- When **[EVF Display Speed]** is set to **[ECO30fps]**
- When using **[Impressive Art]/[Toy Effect]/[Toy Pop]/[Miniature Effect]** in **[Filter Settings]**
- When **[Quality]** is set to **[RAW₁]**, **[RAW₂]** or **[RAW]**
- When recording with the **Post Focus** function
- When using **[Panorama Shot]**
- When **[HDR]** is set to **[ON]**
- When using **[Multi Exp.]**

[Step Zoom]

You can set that zooming operates in steps, stopping at (equivalent) focal lengths familiar from 35mm film cameras. Using [Step Zoom] is as easy as normal zoom operation.

- By default you can use Step Zoom by rotating the control ring in the following exposure control modes:

- Snapshot mode
- Program mode
- Aperture-Priority mode

(A) Current zoom position (focal lengths displayed are the equivalents of 35mm film cameras)

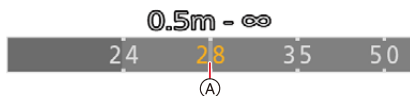

- If you change the [Control Ring] setting in the [Custom] ([Operation]) menu to [Step Zoom], Step Zoom becomes available for other modes as well. (→54)

■ Using the zoom lever for [Step Zoom]

You can use Step Zoom by setting [Zoom lever] in the [Custom] ([Operation]) menu to [Step Zoom]. (→186)

⊘ Not available in these cases:

- Step Zoom cannot be operated with the control ring when using Manual Focus mode.
- This function is not available in the following cases:
 - During video recording
 - When recording with [4K Pre-Burst]
 - When using [Panorama Shot]

Zooming using touch operations (Touch zoom)

1 Touch [**<**].

2 Touch [**↕**].

- The slide bar is displayed.

3 Perform zoom operations by dragging the slide bar.

- The zoom speed varies depending on the touched position.

[▼]/[▲]	Zooms slowly
[▼▼]/[▲▲]	Zooms quickly

- To end touch zoom operations, touch [**↕**] again.

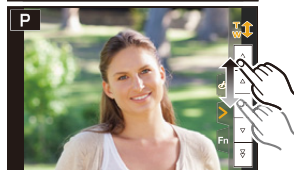

Using the Supplied Flash Unit

Available in the following modes: **A** **AV** **P** **A** **S** **M**

- This section uses the flash to provide instructions.
- For details about how to attach other flash units than the supplied one, refer to their instructions.

Attaching the flash unit

■ Removing the hot shoe cover

The camera comes with a hot shoe cover inserted into the hot shoe.

Remove the hot shoe cover by pulling it in the direction indicated by arrow ② while pressing it in the direction indicated by arrow ①.

- Be sure to insert the hot shoe cover when the hot shoe is not in use.
- Keep the hot shoe cover in a safe place after removing it so that you do not lose it.
- Keep the hot shoe cover out of reach of children to prevent swallowing.

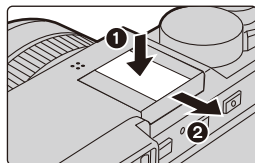

■ Attaching the flash unit

1 Set the on/off switches of the camera and flash unit to [OFF].

2 Firmly insert the flash unit into the hot shoe of the camera until it clicks. (A)

- When recording, set the on/off switches of the camera and flash to [ON].

- (A) Hot shoe
- (B) Flash [ON/OFF] switch
- (C) Lock release button

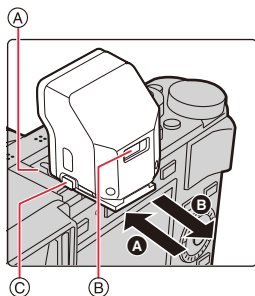

■ Removing the flash unit

1 Turn off the camera and the flash unit.

2 Press and hold the lock release button and pull the flash unit in the direction indicated by the arrow. (B)

- When detaching the flash, do so slowly and carefully.
- Insert the hot shoe cover into the hot shoe of the camera.
- Store the detached flash unit in its soft case.



In the following cases, the flash mode is fixed to [⊗] ([Forced Flash Off]).

- When recording videos
- When recording 4K pictures
- When recording with the Post Focus function
- When using [Panorama Shot]
- When using the electronic shutter function
- When an image effect in [Filter Effect] of [Filter Settings] is set
- When [Silent Mode] is set to [ON]
- When [HDR] is set to [ON]



When using other commercially available flash units without communication functions with the camera

- Set the exposure on the flash unit.
- Set the exposure control mode to Aperture-Priority mode or manual exposure mode. Set the same aperture value and ISO sensitivity setting on the camera and the flash unit.

■ The available flash range when the [Sensitivity] setting is [AUTO]

The edges of the picture may become slightly dark if using flash at short distances with the lens set near its shortest focal length (close to max. W). This may be remedied by setting a slightly longer focal length.

Max. Wide	Max. Tele
Approx. 60cm (2 feet) to 14.1m (46 feet)*	Approx. 30cm (1 foot) to 8.5m (28 feet)*

* When the flash unit is attached, [Sensitivity] is set to [AUTO], and [ISO Auto Upper Limit (Photo)] is set to [AUTO]

- You can set the aperture value, the shutter speed and the ISO sensitivity on the camera even when attaching a flash unit.
- If you record at close range with a short focal length/wide angle setting, light from the flash may be blocked by the lens body, darkening the lower part of the image.
- It may take time to recharge the flash unit if you repeatedly take pictures. You must wait a moment to take the next picture while the flash icon is flashing red indicating the flash is charging.
- Do not bring any objects near the flash unit. The heat and light from the flash may cause the objects to deform or discolor.
- Do not use commercially available flash units with high-voltage synchro terminals, reverse polarity or functions that enable them to communicate with the camera. Doing so may cause the camera to malfunction or operate incorrectly.
- With an attached flash unit, do not hold the camera/flash unit combination by the latter alone because it may detach from the camera.
- Read the instructions of the flash unit for details.

Setting the Flash Functions

- [Flash] in the [Rec] menu is available only when a flash unit is attached.

Changing the flash control mode

Available in the following modes:  P A S M

You can select whether flash output is controlled automatically or manually.

1 Select the menu item.

MENU →  **[Rec]** → **[Flash]** → **[Firing Mode]**



[TTL]	The camera automatically controls the flash output.
[MANUAL]	You can set the flash output manually. Using [TTL] allows you to take a picture as intended, even for dark scenes where the flash output tends to be higher. <ul style="list-style-type: none"> • When [MANUAL] is set, the output level ([1/1], etc.) is displayed on the flash icon on the screen.

2 (When [MANUAL] is selected) Select the menu item.

MENU →  **[Rec]** → **[Flash]** → **[Manual Flash Adjust.]**





3 Press ◀/▶ to set the output level and then [MENU/SET].

Changing the flash modes

Available in the following modes:   **P** **A** **S** **M**



This function allows you to select the flash mode to match the situation.

MENU →  **[Rec]** → **[Flash]** → **[Flash Mode]**

 ((Forced Flash On))  ((Forced On/Red-Eye))*	<p>The flash is fired every time regardless of the recording conditions.</p> <ul style="list-style-type: none"> • Use these modes when your subject is back-lit or under fluorescent light.
 S ((Slow Sync.))  S ((Slow Sync./Red-Eye))*	<p>When taking pictures of dark subjects, these modes will use slower shutter speeds when the flash is fired, so dark backgrounds will appear brighter.</p> <ul style="list-style-type: none"> • Use these modes when you take pictures of people in front of a dark background. • Using a slower speed can cause motion blur. Using a tripod can counteract this.
 ((Forced Flash Off))	<p>The flash is not fired in any recording conditions.</p> <ul style="list-style-type: none"> • Use this when you take pictures in places where the use of flash is not permitted.



* Set [Flash] to the following settings:

– [Firing Mode]: [TTL]

• In Snapshot Plus mode, [A] or [] can be set.

• Some flash modes may not be available depending on the flash unit's settings.

When the flash is fired twice.





The interval between the first and second flash is longer when [] or [] is set. The subject should not move until the second flash is fired.





• The Red-Eye Reduction effect differs between people. Also, if the subject was far away from the camera or was not looking at the first flash, the effect may not be evident.

Available flash settings in the exposure control modes

The available flash settings depend on the exposure control mode.

(○: Available, —: Not available)

Recording mode				 S	 S	
P	Program mode	○	○	○	○	○
A	Aperture-Priority mode	○	○	○	○	○
S	Shutter-Priority mode	○	○	—	—	○
M	Manual Exposure mode	○	○	—	—	○

• In the Snapshot modes ( or ), the flash mode will be set to [A] or [].

■ Shutter speed for each flash mode

Flash mode	Shutter speed	Flash mode	Shutter speed
	1/60s* to 1/4000s		1s to 1/4000s

* This becomes 60 seconds in Shutter-Priority mode and [T] (Time) in the manual exposure mode.

- In the Snapshot modes (or), the shutter speed changes depending on the identified scene.

Setting 2nd Curtain Sync

Available in the following modes:



2nd curtain sync fires the flash at the end of the exposure as opposed to the normal firing time (at the beginning of the exposure). This can be utilized to create a certain effect (see below).

MENU → [Rec] → [Flash] → [Flash Synchro]

[1ST]	1st curtain sync is the normal method when using flash.	
[2ND]	2nd curtain synchro The light source appears behind the subject, making the picture appear more logical.	

- [2nd] is displayed in the flash icon on the screen if you set [Flash Synchro] to [2ND].
- When a fast shutter speed is set, the effect of [Flash Synchro] may deteriorate.
- You cannot set [] or [] when [Flash Synchro] is set to [2ND].

Flash exposure compensation

Available in the following modes:   **P** **A** **S** **M**

You can adjust the flash exposure to compensate for pictures in which the parts mainly illuminated by the flash would otherwise appear too dark or bright.

1 Select the menu item.



MENU →  **[Rec]** → **[Flash]** → **[Flash Adjust.]**

2 Press / to set the compensation value and then **[MENU/SET]**.

- You can adjust from [-3 EV] to [+3 EV] in steps of 1/3 EV.
- Select [± 0] to return to the original flash output.

• [+] or [-] is displayed on the flash icon in the screen when the flash level is adjusted.

Synchronizing the output of the flash to the exposure compensation set for the ambient light

Available in the following modes:   **P** **A** **S** **M**

When [Auto Exposure Comp.] is set to [ON], the flash output level will automatically be controlled to match the exposure compensation set for the exposure of the ambient light.

MENU →  **[Rec]** → **[Flash]** → **[Auto Exposure Comp.]**

Settings: **[ON]/[OFF]**

• For details on Exposure Compensation, refer to (→90).

Recording Videos

Available in the following modes: 

This camera can record videos in different resolutions, including 4K in the MP4-format. (→154).

Audio will be recorded in stereo.

- You can record videos by manually setting the aperture value and shutter speed. (→63)
- The camera automatically sets the aperture value and shutter speed and identifies the optimal scene mode to record videos in the Snapshot modes. (→56)

1 Start recording by pressing the video button.

- (A) Elapsed recording time
- (B) Available recording time

- The recording state indicator (red) © will flash while recording videos.
- Release the video button right after you press it.
- m: minute, s: second

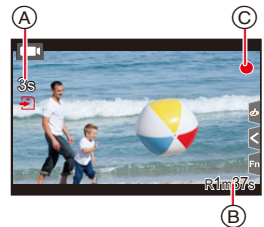
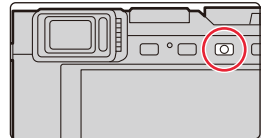

2 Stop the recording by pressing the video button again.

- **When recording in a quiet environment, the sound of aperture and focus operation may be recorded in videos.**

This is not a malfunction. The focus operation during recording of videos can be set to [OFF] in [Continuous AF] (→155).



- If the operation sound of the video button pressed to end recording bothers you, try the following:
 - Record the video about three seconds longer, and then cut off the last part of the video using [Video Divide] in the [Playback] menu.

Recording videos with reduced operational sounds

Available in the following modes:  P A S M

When you operate the zoom, buttons, etc. while recording videos, the sounds associated with such operations may be recorded. Using touch operations allows silent operation.

1 Touch  while recording a video.

2 Touch the desired icon.

 : Zoom



ISO : ISO sensitivity



 : Exposure compensation*

 : Sound recording level adjustment



* It is displayed when [Exposure Comp.] is set in a function button. (→49)

3 Drag the slide bar to adjust the setting.

/[]: Adjusts the setting slowly

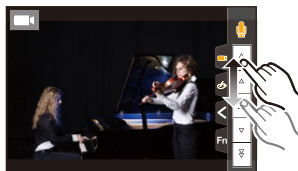
/[]: Adjusts the setting quickly



- When the ambient temperature is high or a video is recorded for an extended time, the camera may display  and then stop the recording. Wait until the camera cools down.
- When the aspect ratio setting is different in still and videos, the angle of view changes at the start of video recording.
When [Rec Area] in the [Custom] menu ([Monitor / Display]) is set to , angle of view during video recording is displayed.
- If the Extra Optical Zoom are used before pressing the video button, those settings will be cleared, so the angle of view will change dramatically.
- The operational sound of the zoom or button operation may be recorded when it is operated during the recording of a video.
- The zoom speed decreases during the recording of a video.
- Depending on the type of the card, the card access indication may appear for a while after recording videos. This is not a malfunction.

Not available in these cases:

- Videos cannot be recorded in the following cases:
 - When using [Rough Monochrome]/[Silky Monochrome]/[Soft Focus]/[Star Filter]/[Sunshine] in [Filter Settings]
 - When recording with the Post Focus function
 - When using [Panorama Shot]
 - When taking pictures with [Time Lapse Shot]
 - When using [Stop Motion Animation]

Setting the resolution/frame rate combination

MENU →  **[Motion Picture]** → **[Rec Quality]**

Item	Size	Recording frame rate	Sensor output	Bit rate
[4K/100M/30p] *	3840×2160	30p	30 frames/second	100 Mbps
[4K/100M/24p] *	3840×2160	24p	24 frames/second	100 Mbps
[FHD/28M/60p]	1920×1080	60p	60 frames/second	28 Mbps
[FHD/20M/30p]	1920×1080	30p	30 frames/second	20 Mbps
[HD/10M/30p]	1280×720	30p	30 frames/second	10 Mbps

* 4K videos





- The higher the Bit rate value is, the higher the image quality becomes. Since the camera employs the VBR recording method, the bit rate is changed automatically depending on the subject to record. As a result, the recording time is shortened when a fast-moving subject is recorded.
- 4K video settings are not available for [Miniature Effect] in [Filter Settings].
- When recording videos in 4K, use a card rated as UHS Speed Class 3.
- When you record 4K videos, the captured image area will be smaller than videos with other resolutions.
- To ensure highly accurate focus, 4K videos are recorded at reduced Autofocus speeds. It may be difficult to focus on the subject with Autofocus, but this is not a malfunction.
- Refer to (→30) for information about continuous recordable times.

■ About the compatibility of the recorded videos

Videos in the MP4 format may not be played back even on devices that support the format. In other cases, the videos may be played back with poor image or sound quality or their recording information may not be displayed correctly. In these cases, play them back on the camera.

- For details about 4K videos recorded with the camera, refer to "Watching/Saving 4K Videos on an External Device" on (→254).

How to set the focusing mode when recording a video ([Continuous AF])

Available in the following modes:     

The focusing procedure varies depending on the Focus mode setting and the [Continuous AF] setting in the [Motion Picture] menu.

MENU →  **[Motion Picture]** → **[Continuous AF]**

Focus mode	[Continuous AF]	Description of settings
[AFS]/[AFF]/ [AFC]	[ON]	The camera automatically keeps focusing on subjects during recording.
	[OFF]	The camera maintains the focus position at the start of recording.
[MF]	[ON]/[OFF]	You can focus manually.

- When the focusing mode is set to [AFS], [AFF] or [AFC], if you press the shutter button halfway while recording a video, the camera will re-adjust the focus continually as necessary.
- The operational noises may be recorded when Autofocus is operated while recording a video. We recommend setting [Continuous AF] to [OFF] to avoid the noise.
- When using the lens' zoom function while recording videos, it may take time to come into focus.

Recording pictures while recording videos

Available in the following modes: **A** **AV** **P** **A** **S** **M**

You can record pictures while recording a video. (Simultaneous recording)

During video recording, press the shutter button fully to record a picture.

- Simultaneous recording indicator is displayed while recording pictures.
- Recording with the Touch Shutter function is also available.

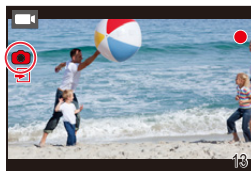

Setting the video priority or picture priority mode

Available in the following modes: **A** **AV** **P** **A** **S** **M**

MENU → **Motion Picture** → **Picture Mode in Rec.**

<p>[Video Priority] ([Video Priority])</p>	<ul style="list-style-type: none"> • Pictures will be recorded with a resolution determined by the [Rec Quality] setting for videos. • Only JPEG images are recorded when [Quality] is set to [RAW] or [RAW]. (When set to [RAW], pictures will be recorded in [Quality] of [RAW].) • You can take up to 40 pictures. (Up to 10 pictures during 4K video recording)
<p>[Photo Priority] ([Photo Priority])</p>	<ul style="list-style-type: none"> • Pictures will be recorded with the set resolution, format, and compression rate. • The screen will go dark while recording pictures. A picture will be recorded in the video during that period, and audio is not recorded. • You can take up to 10 pictures. (Up to 5 pictures during 4K video recording)

- The aspect ratio will be fixed to [16:9].



Not available in these cases:

- When **[Photo Priority]** is set, simultaneous recording is not possible in the following cases:
 - When [Rec Quality] is set to [4K/100M/24p]
 - When the shutter release mode is set to 4K Photo

Displaying/setting the sound recording level

[Sound Rec Level Disp.]

Available in the following modes:   **P** **A** **S** **M**

The sound recording level is displayed on the recording screen.

MENU →  **[Motion Picture]** → **[Sound Rec Level Disp.]**



Settings: **[ON]/[OFF]**



Not available in these cases:

- [Sound Rec Level Disp.] is fixed to [OFF] in the following case:
 - When using [Miniature Effect] in [Filter Settings]

[Sound Rec Level Adj.]

Available in the following modes:   **P** **A** **S** **M**

The sound input level can be set to 4 different levels (–12 dB to +6 dB).

MENU →  **[Motion Picture]** → **[Sound Rec Level Adj.]**

- Displayed dB values are approximate.



Not available in these cases:

- [Sound Rec Level Adj.] does not work in the following case:
 - When using [Miniature Effect] in [Filter Settings]

Playing Back Pictures

1 Press [▶].

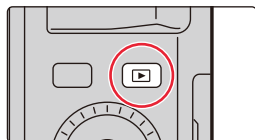

2 Press ◀/▶.

◀: Plays back the previous picture

▶: Plays back the next picture

- If you press and hold ◀/▶, you can play back the pictures in succession.
- Previous or next pictures can also be accessed by rotating the control dial or dragging the screen horizontally.
- You can access previous and next pictures continuously by keeping your finger on the left or right sides of the screen after forwarding/rewinding a picture.



■ To exit playback

Press [▶] again or press the shutter button halfway.

- The playback screen is displayed if you set the camera on/off switch to [ON] while pressing and holding [▶].
- When [Lens Retraction] in the [Custom] ([Lens / Others]) menu is set to [ON], the lens barrel will retract approx. 15 seconds after switching from the recording screen to the playback screen.

⊗ Not available in these cases:

- The camera complies with the DCF standard "Design rule for Camera File system" established by JEITA "Japan Electronics and Information Technology Industries Association" and with Exif "Exchangeable Image File Format". The camera can only display pictures that comply with the DCF standard.
- The camera may not play back images recorded on other devices correctly, and the functions of the camera may not be available for the images.

Playing Back Videos

The camera was designed to play videos using the MP4 format.

Select an icon indicated with [A], and then press **▲** to play it back.

(A) Video recording time

- After playback starts, the elapsed playback time is displayed on the screen.

For example, 8 minutes and 30 seconds is displayed as [8m30s].

- Touching [▶] in the middle of the screen allows you to play back videos.



■ Operations during video playback

Button operation	Touch operation	Description of operation
▲	▶/	Play/Pause
◀	◀◀	Fast rewind*
	◀	Frame-by-frame rewind (while pausing)
⊙	−	Reduce volume level

Button operation	Touch operation	Description of operation
▼	■	Stop
▶	▶▶	Fast forward*
	▶	Frame-by-frame forward (while pausing)
⊙	+	Increase volume level

* The fast forward/rewind speed increases if you press ▶/◀ again.

- Videos can be viewed on your computer using the software available after registering your camera on the Leica Camera AG home page (→257).

Creating pictures from a video

1 Press ▲ to pause video playback.

- Press ◀▶ to fine-adjust the pause position while the video is paused.

2 Press [MENU/SET].

- The same operation can be performed by touching [⏏] [▶].



- Pictures will be saved with aspect ratio set to [16:9] and [Quality] set to [📺].

The resolution will differ according to the video you play back.

[Rec Quality]	[Picture Size]
[4K]	[M] (8M)
[FHD]/[HD]	[S] (2M)

- Pictures created from a video may have a lower resolution than with normal picture quality.
- [📺] is displayed during playback of pictures created from videos.



Switching the Playback Method

Using the playback zoom

Rotate the zoom lever towards the [T] side.

1× → 2× → 4× → 8× → 16×



Button operation	Touch operation	Description of operation
	—	Enlarges/reduces the screen.
—	Pinching out/in	Enlarges/reduces the screen in small steps.
	Dragging	Moves the enlarged area (during enlarged display).
	—	Calls up the previous or next image while maintaining the same zoom magnification and zoom position (during enlarged display).

- Touch the screen twice to switch between the enlarged display and normal display.

Displaying multiple screens (Multi Playback)

Rotate the zoom lever towards the [W] side.

1 screen → 12 screens → 30 screens → Calendar display

- Rotate the zoom lever to the [T] side to return to the previous display mode.
- You can also switch the playback screen by touching the following icons:
 - [■]: 1 screen
 - [■□]: 12 screens
 - [■□□]: 30 screens
 - [CAL]: Calendar screen display
- You can also scroll the list display by dragging the screen up/down.
- Pictures displayed using [[!]] cannot be played back.

■ To return to normal playback

Press ▲/▼/◀/▶ to select a picture and then [MENU/SET].

- If you select a video, it will be played back automatically.

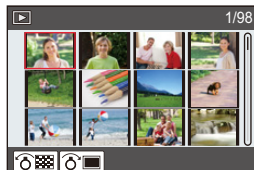

Displaying pictures by recording date (Calendar Playback)

1 Rotate the zoom lever to the [W] side to display the Calendar display.

2 Press ▲/▼/◀/▶ to select the recording date and then [MENU/SET].

- Only the images recorded on that date will be displayed.
- To return to the Calendar display, rotate the zoom lever to the [W] side.

3 Press ▲/▼/◀/▶ to select a picture and then [MENU/SET].



- The recording date of the picture selected in the playback screen becomes the date selected when the calendar screen is first displayed.
- You can display the calendar between January 2000 and December 2099.
- If the date is not set in the camera, the recording date is set as the 1st January, 2018.
- If you take pictures after setting the travel destination in [World Time], the pictures are displayed by the dates at the travel destination in Calendar Playback.

Playing Back Group Pictures

A picture group consists of multiple pictures. You can play back pictures in a group either continuously or one by one.

- You can edit or delete all pictures in a group at once.

(For example, if you delete a picture group, all pictures in the group are deleted.)



A picture group saved simultaneously with [4K PHOTO Bulk Saving].



A picture group consisting of pictures taken with Focus Bracketing.



A picture group consisting of pictures taken in a Time Lapse Shot.



A picture group consisting of pictures taken with Stop Motion Animation.

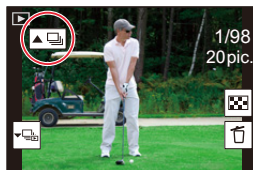

- Pictures will not be grouped if recorded without setting the clock.

■ Continuously playing back group pictures

Press ▲.

- The same operation can be performed by touching the group picture icon ([▲🖼️], [▲📷], [▲📱]).
- When playing back group pictures one at a time, options are displayed. After selecting [Burst Play] (or [Sequential Play]), select either of the following playback methods:
[From the first picture]:
Pictures are played back continuously from the first picture of the group.
[From the current picture]:
Pictures are played back continuously from the picture being played back.
- Operations during continuous playback

Button operation	Touch operation	Description of operation
▲	▶/	Continuous playback/Pause
◀	◀◀	Fast rewind
	◀◀	Rewind (while pausing)

Button operation	Touch operation	Description of operation
▼	■	Stop
▶	▶▶	Fast forward
	▶▶	Forward (while pausing)

■ Playing back group pictures one by one

1 Press ▼.

- The same operation can be performed by touching [▼🖼️], [▼📷], or [▼📱].

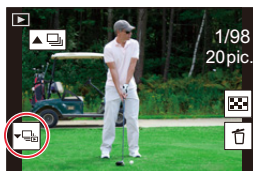

2 Press ◀/▶ to flip through images.

- To return to the normal playback screen, press ▼ again or touch [▼🖼️].
- Each picture in a group can be treated the same as normal pictures when they are played back. (Such as Multi Playback, Playback Zoom and deleting images)

Deleting Pictures

Once deleted, pictures cannot be recovered.

■ To delete a single picture

- 1 In playback mode, select the picture to delete and then press [🗑️/↵].

- The same operation can be performed by touching [🗑️].

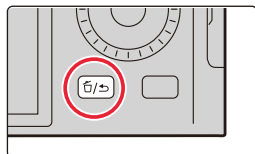

- 2 Press ▲/▼ to select [Delete Single] and then [MENU/SET].

■ To delete multiple pictures (up to 100) or all the pictures

- Picture groups are treated as a single picture. (All the pictures in the selected picture group will be deleted.)

- 1 In Playback Mode, press [🗑️/↵].

- 2 Press ▲/▼ to select [Delete Multi] or [Delete All] and then [MENU/SET].

- After selecting [Delete All], if you select [Delete All Non-rating], you can delete all pictures except for those with ratings.

(When [Delete Multi] is selected)

- 3 Press ▲/▼/◀/▶ to select the picture, and then [MENU/SET]. (Repeat this step.)

- Ⓐ 🗑️ Picture selected

- To cancel the selection, press [MENU/SET] again.

- 4 Press [DISP] to execute.

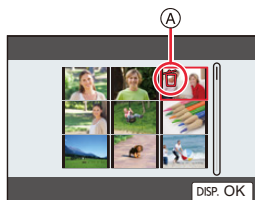

- Depending on the number of pictures to be deleted, it may take some time to delete them.

Menu List

[Snapshot Mode] menu	(→166)	(A)
[Rec] menu	(→166)	
[Motion Picture] menu	(→179)	
[Custom] menu	(→180)	
[Setup] menu	(→195)	(B)
[My Menu] menu	(→204)	
[Playback] menu	(→205)	

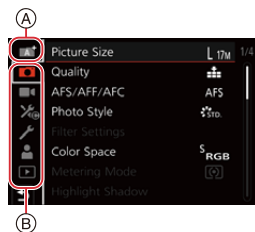
A **A+**: [Snapshot Mode] menu

- [Snapshot Mode] (→57)
- [iHNR] (→59)
- [iHandheld Night Shot] (→59)

📷: [Rec] menu

- [Picture Size] (→167)
- [Quality] (→168)
- [AFS/AFF/AFC] (→74)
- [Photo Style] (→169)
- [Filter Settings] (→122)
- [Color Space] (→171)
- [Metering Mode] (→171)
- [Highlight Shadow] (→172)
- [i.Dynamic] (→173)
- [i.Resolution] (→173)
- [Flash] (→149)
- [Red-Eye Removal] (→173)
- [ISO Auto Upper Limit (Photo)] (→174)
- [Min. Shtr Speed] (→174)
- [Long Shtr NR] (→174)
- [Diffraction Compensation] (→175)
- [Stabilizer] (→139)
- [i.Zoom] (→142)
- [Digital Zoom] (→143)
- [Burst Rate] (→98)
- [4K PHOTO] (→100)
- [Self Timer] (→115)
- [Time Lapse Shot] (→133)
- [Stop Motion Animation] (→136)
- [Panorama Settings] (→119)
- [Silent Mode] (→175)
- [Shutter Type] (→176)
- [Bracket] (→129)
- [HDR] (→177)
- [Multi Exp.] (→178)

[Picture Size]

Available in the following modes:      

The higher the resolution (number of pixels), the finer the detail of the pictures will appear even when they are printed in large formats.

MENU →  **[Rec]** → **[Picture Size]**

Aspect ratio	[4:3]	[1:1]	[16:9]	[3:2]
[Picture Size]	[L] (17M) 4736×3552	[L] (12.5M) 3552×3552	[L] (15M) 5152×2904	[L] (16M) 4928×3288
	[EXM] (8.5M) 3360×2520	[EXM] (6.5M) 2528×2528	[EXM] (8M) 3840×2160	[EXM] (8M) 3504×2336
	[EXS] (4M) 2368×1776	[EXS] (3M) 1776×1776	[EXS] (2M) 1920×1080	[EXS] (4M) 2496×1664

**Not available in these cases:**

- [Picture Size] cannot be set in the following cases:
 - When using [Panorama Shot]
 - When recording 4K pictures
 - When recording with the Post Focus function

Setting the file format/compression rate ([Quality])

Available in the following modes: **P** **A** **S** **M**

This function allows you to select the file format, e. g. JPEG and/or RAW, and in the case of JPEG, the compression rate. RAW is especially suited for the subsequent comprehensive editing of the image data using respective software, which is available after registering your camera on the Leica Camera AG homepage (→257). The JPEG setting delivers higher image quality than due to its lower compression rate, while the latter has the advantage of smaller files.

Set the compression rate at which the pictures are to be stored.

MENU → **[Rec]** → **[Quality]**

Settings	File format	Description of settings
	JPEG	A JPEG image in which image quality was given priority.
		A standard image quality JPEG image. This is useful for increasing the number of shots without changing the resolution.
	RAW+JPEG	You can record a RAW image and a JPEG image (or) simultaneously.
	RAW	You can only record RAW images.



About RAW

The RAW format refers to a data format of images that have not been processed. Playback and editing of RAW images require the camera or the dedicated software.

- You can process RAW images in [RAW Processing] in the [Playback] menu. (→210)

- When you delete an image recorded with or , both the RAW and JPEG images will be deleted simultaneously.
- When you play back an image recorded with , gray areas corresponding to the aspect ratio at the time of recording are displayed.
- The setting is fixed to when recording is performed with the 4K Photo or Post Focus function.



Not available in these cases:









- You cannot set to , or in the following case:
 - When using [Panorama Shot]

[Photo Style]

Available in the following modes:  P A S M

You can select color rendition effects to match the type of image you wish to record.

MENU →  **[Rec]/**  **[Motion Picture]** → **[Photo Style]**

 [Standard]	This is the standard setting.
 [Vivid]	Brilliant effect with higher saturation and contrast.
 [Natural]	Soft effect with lower contrast.
 [Monochrome]	Creates black-and-white pictures.
 [Monochrome HC]	Creates black-and-white pictures with rich gradation and crisp black accents.
 [Monochrome HC+]	Creates black-and-white pictures with a dynamic impression with enhanced highlights and shadows.
 [Scenery]	An effect appropriate for sceneries with vivid blue skies and greens.
 [Portrait]	An effect appropriate for portraits with a healthy and beautiful skin tone.
 [Custom]	This uses a setting registered in advance.

• In Snapshot Plus mode:

- Only [Standard] or [Monochrome] can be set.
- The setting will be reset to [Standard] when the camera is switched to another exposure control mode or turned off.

■ Adjusting the picture parameters

- You cannot adjust the picture parameters in Snapshot Plus mode.

- Press **◀/▶** to select the type of Photo Style.
- Press **▲/▼** to select the items, and then **◀/▶** to adjust.

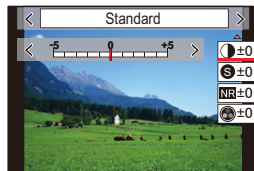

☉ [Contrast]	[+]	Increases the contrast in a picture.
	[-]	Decreases the contrast in a picture.
Ⓢ [Sharpness]	[+]	Enhances the outlines in a picture.
	[-]	Softens the outlines in a picture.
NR [Noise Reduction]	[+]	Increases noise reduction to reduce noise. This setting may slightly lower the resolution.
	[-]	Lowers the noise reduction effect to achieve a picture quality with clearer resolution.
🌈 [Saturation] ^{*1}	[+]	Gaudy coloring.
	[-]	Subdued coloring.
🌈 [Color Tone] ^{*1}	[+]	Adds a bluish tone.
	[-]	Adds a yellowish tone.
🌈 [Filter Effect] ^{*2}	[Yellow]	Enhances the contrast of an subject. (Effect: Weak) Records a blue sky clearly.
	[Orange]	Enhances the contrast of an subject. (Effect: Medium) Records the sky in darker blue.
	[Red]	Enhances the contrast of an subject. (Effect: Strong) Records the sky in a much darker blue.
	[Green]	The skin and lips of people appear in natural tones. Green leaves appear brighter and more enhanced.
	[Off]	—
🌫️ [Grain Effect] ^{*2}	[Low]/ [Standard]/ [High]	Sets the graininess in a picture.
	[Off]	—

*1 [Color Tone] is displayed only when [Monochrome], [Monochrome HC] or [Monochrome HC+] is selected. In other cases, [Saturation] will be displayed.

*2 Displayed only when [Monochrome], [Monochrome HC] or [Monochrome HC+] is selected.

- If you adjust the picture quality, [-] is displayed beside the Photo Style icon on the screen.

- Press **[MENU/SET]**.

■ Registering settings to [Custom]

Press **[DISP]** in step 2 of “Adjusting the picture parameters”.

- The effect of [Grain Effect] cannot be checked on the recording screen.
- [Grain Effect] is not available in the following cases.
 - Panorama Shot mode
 - When recording videos
 - When recording 4K pictures
 - When recording with the Post Focus function

[Color Space]

Available in the following modes:  P A S M

This mode allows setting the method for reproducing the correct colors to output the recorded images to a computer screen or a device such as a printer.

MENU →  **[Rec]** → **[Color Space]**

[sRGB]	The color space is set to sRGB. This is widely used in computer related equipment.
[AdobeRGB]	The color space is set to AdobeRGB. AdobeRGB is mainly used for business purposes such as professional printing because it has a greater range of reproducible colors than sRGB.





- Set to [sRGB] if you are not very familiar with AdobeRGB.
- The setting is fixed to [sRGB] in the following cases:
 - When recording videos
 - When recording 4K pictures
 - When recording with the Post Focus function

[Metering Mode]

Available in the following modes:  P A S M

You can select between three different exposure metering methods.

MENU →  **[Rec]/** **[Motion Picture]** → **[Metering Mode]**

[Metering Mode]	Metering characteristics	Conditions
[ (Multiple)	The brightness is detected in different sections of the frame. The exposure is then based on the probable main subject.	Normal usage (high probability of automatically correctly exposed main subjects even with greater brightness differences)
[ (Center weighted)	The metering sensitivity is concentrated on the center while also registering the rest of the frame.	Use when subject is in the center, or to deliberately base the exposure on an off-center subject (provided, subject is of medium brightness)
[ (Spot)	Center of [+] (spot metering target) 	Use to base the exposure on very small subject parts (provided, these parts are of medium brightness)

- If you set the spot metering target on the edge of the screen, the metering result may be affected by the brightness around the location.

[Highlight Shadow]

Available in the following modes: P A S M

You can adjust the highlights and shadows in a picture while checking the results on the screen.

MENU → [Rec]/ [Motion Picture] → **[Highlight Shadow]**

<input type="checkbox"/> (Standard)	No adjustments
<input checked="" type="checkbox"/> (Raise the contrast)	Bright areas are brightened, and dark areas are darkened.
<input checked="" type="checkbox"/> (Lower the contrast)	Bright areas are darkened, and dark areas are brightened.
<input checked="" type="checkbox"/> (Brighten dark areas)	Dark areas are brightened.
/ / (Custom)	Registered custom settings can be applied.

1 Rotate the control ring to adjust the brightness of bright areas / dark areas.

(A) Bright side

(B) Dark side

• Adjustments can also be made by dragging the graph.

• To register a preferred setting, press , and select the destination where the custom setting will be registered to ([Custom1] ()/[Custom2] ()/[Custom3] ()).

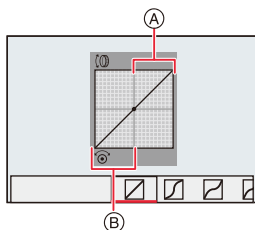

2 Press **[MENU/SET]**.

• The screen display can be switched by pressing [DISP] on the brightness adjustment screen.

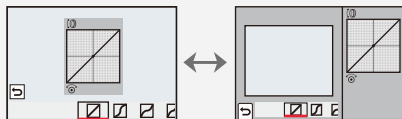



• Turning off the camera will return the setting adjusted with / / / back to the default setting.

Not available in these cases:

- [Highlight Shadow] cannot be set in the following cases:
 - When using [Panorama Shot]
 - When using [Filter Settings]

[i.Dynamic]

Available in the following modes:   **P A S M**

This function automatically adjusts contrast and exposure to give more lifelike colors when there is significant contrast between background and subject.



MENU →  **[Rec]/**  **[Motion Picture]** → **[i.Dynamic]**

Settings: **[AUTO]/[HIGH]/[STANDARD]/[LOW]/[OFF]**

 **Not available in these cases:**

- The compensation effect may not be achieved depending on the recording conditions.
- [i.Dynamic] does not work in the following cases:
 - When using [Panorama Shot]
 - When [HDR] is set to [ON]

[i.Resolution]



Available in the following modes:   **P A S M**

You can use the camera's Intelligent Resolution technology to record pictures with sharper outlines and clearer resolution.

MENU →  **[Rec]/**  **[Motion Picture]** → **[i.Resolution]**

Settings: **[HIGH]/[STANDARD]/[LOW]/[OFF]**



[Red-Eye Removal]

Available in the following modes:   **P A S M**

If you fire the flash when using Red-Eye Reduction ([] or []), the camera automatically detects red-eye and corrects the picture.

MENU →  **[Rec]** → **[Red-Eye Removal]**

Settings: **[ON]/[OFF]**

- If you set this item to [ON], the icon will change to [] or [].
- Under certain circumstances, red-eye cannot be corrected.

[ISO Auto Upper Limit (Photo)]

Available in the following modes:  **P A S M**

You can set the upper limit of the ISO sensitivity when it is set to [AUTO] or [ISO].

MENU →  **[Rec]** → **[ISO Auto Upper Limit (Photo)]**

Settings: [AUTO]/[400]/[800]/[1600]/[3200]/[6400]/[12500]/[25000]

[Min. Shtr Speed]

Available in the following modes:  **P A S M**

You can set the minimum shutter speed when the ISO sensitivity is set to [AUTO] or [ISO].

MENU →  **[Rec]** → **[Min. Shtr Speed]**

Settings: [AUTO]/[1/16000] to [1/1]

- The shutter speed may become slower than the set value in situations where proper exposure cannot be obtained.

**Not available in these cases:**

- The desired compensation effect may not be achieved depending on the recording conditions.
- [Min. Shtr Speed] cannot be set in the following case:
 - When using [Panorama Shot]

[Long Shtr NR]

Available in the following modes:  **P A S M**

The camera automatically removes noise that appears when using slower shutter speeds, e.g. to take pictures of night or similar scenery.

MENU →  **[Rec]** → **[Long Shtr NR]**

Settings: [ON]/[OFF]

- [Long shutter noise reduction ongoing] is displayed for the same time as the shutter speed for signal processing.

**Not available in these cases:**

- This function is not available in the following cases:
 - When recording videos
 - When recording 4K pictures
 - When recording with the Post Focus function
 - When using [Panorama Shot]
 - When using the electronic shutter function

[Diffraction Compensation]

Available in the following modes:  P A S M

The camera raises the resolution by correcting the blurriness caused by diffraction when small apertures (high aperture values) are used.

MENU →  **[Rec]** /  **[Motion Picture]** → **[Diffraction Compensation]**

Settings: [AUTO]/[OFF]

- Noise may increase with higher ISO sensitivity.

[Silent Mode]

Available in the following modes:  P A S M



This function allows disabling the beeps and firing the flash at the same time.

MENU →  **[Rec]** → **[Silent Mode]**

Settings: [ON]/[OFF]

- Audio from the speaker will be muted and flash operation and the AF Assist lamp will be disabled.

The following settings are fixed.

- [Flash Mode]:  ([Forced Flash Off])
- [Shutter Type]: [ESHTR]
- [AF Assist Lamp]: [OFF]
- [Beep Volume]:  (OFF)
- [Shutter Vol.]:  (OFF)

- Even when [ON] is set, the following functions light up/flash:
 - WIRELESS connection lamp
 - Self-timer indicator
- The operation sounds of the camera such as setting of the aperture are not muted.
- **Be sure to pay special attention to the privacy, i.e. personal rights, etc. of the subject when you use this function. Use at your own risk.**

[Shutter Type]

Available in the following modes:   **P** **A** **S** **M**

You can use either of the two shutter types to take pictures: the mechanical and the electronic shutter function.

MENU →  **[Rec]** → **[Shutter Type]**

[AUTO]	Switches the shutter type automatically depending on the recording condition and shutter speed. • The mechanical shutter mode has higher priority over the electronic shutter mode because the mechanical shutter has less function-related restrictions when recording with flash, etc.
[MSHTR]	Takes pictures in Mechanical Shutter mode.
[ESHTR]	Takes pictures in Electronic Shutter mode.

	Mechanical shutter	Electronic shutter function
Flash	○	—
Shutter Speed	[T] (Time) ^{*1} /60s to 1/4000s	1s ^{*2} to 1/16000s
Shutter sound	Mechanical shutter sound + Electronic shutter sound ^{*3}	Electronic shutter sound ^{*3}

*1 This setting is available only in manual exposure mode.

*2 Up to an ISO sensitivity of [ISO3200]. When the setting is higher than [ISO3200], the shutter speed will be faster than 1 second.

*3 Electronic shutter sound settings can be changed in [Shutter Vol.] and [Shutter Tone].

• Electronic Shutter mode allows you to take pictures without the detrimental effects caused by shutter vibration.

• When [E] is displayed on the screen, pictures will be taken with the electronic shutter function.

• When [ESHTR] is set, if you take a picture of a moving subject, it may be rendered distorted.

• When [ESHTR] is set, horizontal stripes may appear on pictures taken under lighting such as a fluorescent or LED lighting fixtures. The horizontal stripes can be reduced if you set a slower shutter speed.

[HDR]

Available in the following modes:  **P A S M**

The camera can combine 3 pictures taken at different exposures into a single picture with a wide range of correctly rendered brightness levels. The individual pictures used to create the HDR picture are not saved.

A combined HDR picture is saved in JPEG format.

MENU →  **[Rec]** → **[HDR]**

Settings: **[ON]/[OFF]/[SET]**



■ Changing settings

[Dynamic Range]	<p>[AUTO]: Automatically adjusts the exposure range according to the differences between the bright and dark areas.</p> <p>[±1 EV]/[±2 EV]/[±3 EV]: Sets the exposures within the selected exposure parameters.</p>
[Auto Align]	<p>[ON]: Automatically compensates camera shake and other problems that can cause the images to misalign. Recommended for use during hand-held shooting.</p> <p>[OFF]: Image misalignment is not adjusted. Recommended when a tripod is used.</p>

- Do not move the camera during the exposure series after pressing the shutter button.
- You cannot take the next picture until the combination of pictures is complete.
- A moving subject may be recorded with unnatural blurs.
- The image size becomes smaller when [Auto Align] is set to [ON].
- Flash is fixed to  ([Forced Flash Off]).



Not available in these cases:

- [HDR] does not work for the pictures taken during a video recording.
- This function is not available in the following cases:
 - When recording 4K pictures
 - When recording with the Post Focus function
 - When recording in Continuous mode
 - When using [Panorama Shot]
 - When recording with the Bracket function
 - When [Quality] is set to [RAW, [RAW] or [RAW]
 - When using [Time Lapse Shot]
 - When using [Stop Motion Animation] (only when [Auto Shooting] is set)

[Multi Exp.]

Available in the following modes:  **P A S M**

You can create pictures in which several exposures (up to 4) are superimposed over each other.

MENU →  **[Rec]** → **[Multi Exp.]**



1 Press ▲/▼ to select [Start] and then [MENU/SET].

2 Decide on the composition, and take the first picture.

- After taking the picture, press the shutter button halfway to take the next picture.
- Press ▲/▼ to select the item and then [MENU/SET] for one of the following operations.
 - [Next]: Advance to the next picture.
 - [Retake]: Return to the first picture.
 - [Exit]: Record the image of the first picture, and finish the multiple exposure picture-taking session.



3 Shooting the second, third, and fourth exposures.

- To save the recorded pictures and finish Multiple Exposure, press  /  / ([Fn3]) when taking pictures.

4 Press ▲/▼ to select [Exit] and then [MENU/SET].

- You can also press the shutter button halfway to finish.



■ Changing settings

[Auto Gain]	If you select [OFF], all exposure results are superimposed as they are. If the subject calls for it, the exposures are adjusted accordingly.
[Overlay]	If you select [ON], you can apply Multi Exposure to previously recorded images. After [Start] is selected, images on the card will be displayed. Select a RAW image, and press [MENU/SET] to proceed to recording.

- You cannot use the lens' zoom function when taking the second and subsequent pictures.
- The recording information displayed for pictures taken with multiple exposures is that for the last one taken.
- You can perform [Overlay] only for RAW images recorded with this camera.

Not available in these cases:

- This function is not available in the following cases:
 - When using [Filter Settings]
 - When using [Panorama Shot]
 - When using [Time Lapse Shot]
 - When using [Stop Motion Animation]

■ : [Motion Picture] menu

- [Rec Quality] (→154)
- [AFS/AFF/AFC] (→74)
- [Continuous AF] (→155)
- [Photo Style] (→169)
- [Filter Settings] (→122)
- [Metering Mode] (→171)
- [Highlight Shadow] (→172)
- [i.Dynamic] (→173)
- [i.Resolution] (→173)
- [ISO Auto Upper Limit (Video)] (→179)
- [Diffraction Compensation] (→175)
- [Stabilizer] (→139)
- [i.Zoom] (→142)
- [Digital Zoom] (→143)
- [Picture Mode in Rec.] (→156)
- [Sound Rec Level Disp.] (→157)
- [Sound Rec Level Adj.] (→157)
- [Wind Noise Canceller] (→179)

[ISO Auto Upper Limit (Video)]

Available in the following modes:  **P A S M**

You can set the upper limit of the ISO sensitivity when it is set to [AUTO] or [ISO].

MENU → ■ [Motion Picture] → [ISO Auto Upper Limit (Video)]

Settings: [AUTO]/[400]/[800]/[1600]/[3200]/[6400]

[Wind Noise Canceller]

Available in the following modes:  **P A S M**

If you hear wind noise during an audio recording, you can use [Wind Noise Canceller] to effectively reduce it.

MENU → ■ [Motion Picture] → [Wind Noise Canceller]

Settings: [HIGH]/[STANDARD]/[OFF]

- [HIGH] effectively reduces the wind noise by minimizing the low-pitched sound when a strong wind is detected.
- [STANDARD] extracts and reduces only the wind noise without deteriorating the sound quality.
- You may not hear the full effect depending on the recording conditions.

 **[Custom] menu**
 **[Exposure]**

- [ISO Increments] (→181)
- [Extended ISO] (→181)
- [Exposure Comp. Reset] (→181)

 **[Focus / Release Shutter]**

- [AF/AE Lock] (→89)
- [AF/AE Lock Hold] (→181)
- [Shutter AF] (→181)
- [Half Press Release] (→181)
- [Quick AF] (→181)
- [Eye Sensor AF] (→182)
- [Pinpoint AF Setting] (→182)
- [AF Assist Lamp] (→182)
- [Direct Focus Area] (→182)
- [Focus/Release Priority] (→183)
- [Focus Switching for Vert / Hor] (→183)
- [Loop Movement Focus Frame] (→183)
- [AF Area Display] (→183)
- [AF+MF] (→184)
- [MF Assist] (→184)
- [MF Assist Display] (→184)

 **[Operation]**

- [Fn Button Set] (→49)
- [Q.MENU] (→185)
- [A Button Switch] (→185)
- [Control Ring] (→54)
- [Operation Lock Setting] (→185)
- [Video Button] (→185)
- [Touch Settings] (→185)
- [Dial Guide] (→186)
- [Zoom lever] (→186)

 **[Monitor / Display]**

- [Auto Review] (→186)
- [Monochrome Live View] (→187)
- [Constant Preview] (→187)
- [Live View Boost] (→187)
- [Peaking] (→188)
- [Histogram] (→188)
- [Guide Line] (→189)
- [Center Marker] (→189)
- [Highlight] (→189)
- [Zebra Pattern] (→190)
- [Expo.Meter] (→190)
- [MF Guide] (→190)
- [EVF/Monitor Disp. Set] (→40)
- [Monitor Info. Disp.] (→191)
- [Rec Area] (→191)
- [Remaining Disp.] (→191)

 **[Lens / Others]**

- [Lens Position Resume] (→191)
- [Lens Retraction] (→191)
- [Self Timer Auto Off] (→191)
- [Face Recog.] (→192)
- [Profile Setup] (→194)

MENU →  **[Custom]** →  **[Exposure]**

[ISO Increments]

This item allows adjusting the increments used to set the ISO sensitivity.

Settings: [1/3 EV]/[1 EV]

[Extended ISO]

This item allows setting the ISO sensitivity to a minimum of [ISO100].

[Exposure Comp. Reset]

This item allows resetting the exposure compensation value set with the function button when you change the exposure control mode or turn off the camera.

MENU →  **[Custom]** →  **[Focus / Release Shutter]**

[AF/AE Lock Hold]

When [ON] is selected, the focus and exposure settings stay locked even if you press and release [AE/AF].

To clear the lock, press [AE/AF] again.

[Shutter AF]

This item allows selecting whether or not focusing should start automatically when the shutter button is pressed halfway.

[Half Press Release]

When this mode is activated, the shutter will immediately fire when the shutter button is pressed halfway.

[Quick AF]

This mode enables faster focusing when the shutter button is pressed.

- The battery will be drained faster than usual.



Not available in these cases:

- In Preview mode
- In low light situations

[Eye Sensor AF]

When this mode is activated, the camera automatically starts focusing when the eye sensor registers that the viewfinder is being used.

- [Eye Sensor AF] may not work in dimly lit conditions.

[Pinpoint AF Setting]

This item allows changing the setting for an enlarged display that appears when the Autofocus mode is set to **[+]**.

[Pinpoint AF Time]	Sets the time for which the enlarged screen is displayed when the shutter button is pressed halfway.
[Pinpoint AF Display]	Sets the display mode of the enlarged screen (windowed screen/full screen).





[AF Assist Lamp]

With this mode active, the AF assist lamp lights up for easier focusing when you press the shutter button halfway while recording in a dark location.

- The effective range of the AF assist lamp is 1.5m (5 feet).
- [AF Assist Lamp] is fixed to [OFF] in the following case:
 - When [Silent Mode] is set to [ON]

[Direct Focus Area]

This mode allows moving the AF area or MF Assist using the cursor buttons when recording.

- You can move the positions below with the cursor buttons.
 - When **[]**/**[]**/**[]** is selected: AF area
 - When **[]** is selected: lock-on position
 - When **[+]** is selected: enlarged area
- Use the Quick Menu (→47) or function buttons (→49) to set the functions assigned to the cursor buttons, such as White Balance and ISO sensitivity.
- [Direct Focus Area] is fixed to [OFF] in the following case:
 - When using [Filter Settings]

[Focus/Release Priority]

This item allows selecting whether to give priority to focus or shutter release during Autofocus operation.

- Different settings can be applied to different Focus Mode settings ([AFS/AFF], [AFC]).

[FOCUS]	Disables recording when a subject cannot be focused.
[BALANCE]	Performs recording while controlling the balance between focusing and shutter release timing.
[RELEASE]	Enables recording even when a subject is out of focus.

[Focus Switching for Vert / Hor]

This mode allows storing focus settings separately for the camera's horizontal and vertical orientations.

[ON]	<p>Memorizes separate positions for horizontal and vertical orientations (two vertical orientations, left and right, are available).</p> <ul style="list-style-type: none"> • The following last-specified positions will be memorized. <ul style="list-style-type: none"> – The last AF area position (when [F], [■] or [+]) is used – The last MF Assist display position 	
[OFF]	Sets the same setting for both horizontal and vertical orientations.	

[Loop Movement Focus Frame]

When setting the AF area position or the MF Assist display position, this mode allows jumping directly from one edge to the other edge of the screen.

[AF Area Display]

This mode allows changing the AF area display setting for when the Autofocus mode is set to [] ([49-Area]) or [], etc. ([Custom Multi]).

[ON]	<p>Displays AF areas on the recording screen.</p> <ul style="list-style-type: none"> • AF areas are not displayed when the default AF area setting is applied to [] ([49-Area]) or [C1], [C2] or [C3] in [Custom Multi].
[OFF]	Displays AF areas on the recording screen for just a few seconds after you start using them.

- Even when [ON] is set, the same operation as [OFF] is performed in the following cases:
 - When recording videos
 - When recording 4K pictures





[AF+MF]

With this mode active, you can fine-adjust the focus setting manually during AF lock (when the following conditions are met).

- When [AFS/AFF/AFC] in the [Rec] menu is set to [AFS] and the shutter button is pressed halfway.
- When [AE/AF] is pressed

[MF Assist]

This mode allows setting the display method of MF Assist (enlarged screen).

	Enlarges the display when you rotate the control ring or press [] (▶).
	Enlarges the display when you rotate the control ring.
	Enlarges the display when you press [] (▶).
[OFF]	The screen is not be enlarged.

- MF Assist is not displayed in the following cases:
 - When recording videos
 - When recording with [4K Pre-Burst]
 - When using Digital Zoom

[MF Assist Display]

This mode allows setting whether MF Assist (enlarged screen) will appear in a windowed screen display or in a full screen display.

MENU →  **[Custom]** →  **[Operation]**

[Q.MENU]

By selecting [CUSTOM] in this item, you can customize the Quick Menu settings. (→48)

[A Button Switch]

This mode allows changing the operation method of the [A] button.

[Single Press]	Switches the camera between the Snapshot and the other exposure control modes (P/A/S/M) when you press [A].
[Press and hold]	Switches the camera between the Snapshot and the other exposure control modes (P/A/S/M) when you press and hold [A] for a short while.

[Operation Lock Setting]

This item allows setting which control functions will be disabled when [Operation Lock] is set in [Fn Button Set] (→49) of the [Custom] ([Operation]) menu.

[Cursor]	Disables the functions of the cursor and the [MENU/SET] buttons.
[Touch Screen]	Disables the touch functions of the monitor.
[Dial]	Disables the functions of the control dial and control ring.

[Video Button]

This item allows enabling/disabling the video button.

[Touch Settings]

This item allows enabling/disabling touch operations.



[Touch Screen]	All touch operations.
[Touch Tab]	Operating of tabs, such as  on the right side of the screen.
[Touch AF]	Bringing the subject you touch into focus ([AF]) or adjusting the focus and brightness settings ([AF+AE]). (→85)
[Touch Pad AF]	Moving the AF area by touching the monitor when the viewfinder is in use. (→84)

[Dial Guide]

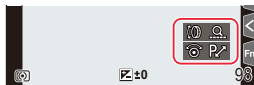

This item allows enabling/disabling the operation guide display when switching recording modes.

**[Zoom lever]**

This item allows selecting which type of zoom operation is performed with the zoom lever.

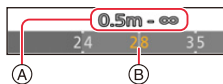
 (Zoom)	Performs normal zooming.
 (Step Zoom)	<p>Stops zooming at the position for one of the preset focal lengths each time you operate the zoom lever.</p> <ul style="list-style-type: none"> This does not work for video recording or [4K Pre-Burst] recording. <p>(A) Focusing range (B) Current zoom position</p>



MENU →  **[Custom]** →  **[Monitor / Display]**

[Auto Review]

This item allows selecting how a picture/which pictures is/are displayed immediately after it/they is/are taken.

[Duration Time (photo)]	Sets the display time of the images recorded after picture-taking.
[Duration Time (4K PHOTO)]	Sets whether to display/hide the images recorded after 4K photo recording.
[Duration Time (Post Focus)]	Sets whether to display/hide the recorded images after recording with the Post Focus function.
[Playback Operation Priority]	Allows you to change or delete the playback image during Auto Review.

- When [Duration Time (photo)] is set to [HOLD], the images are displayed until the shutter button is pressed halfway. [Playback Operation Priority] will be fixed to [ON].
- When [Grain Effect] is selected for [Photo Style], [Auto Review] is not displayed during [Time Lapse Shot] and [Stop Motion Animation] recording.

[Monochrome Live View]

This item allows you to select a black and white recording screen.

This is convenient for focusing manually.

- Recorded images will not be affected.

[Constant Preview]

This mode allows you to check the effects of the chosen aperture and shutter speed on the recording screen in manual exposure mode.

- This function does not work when using flash.

[Live View Boost]

With this mode activated, the monitor image is displayed brighter to make it easier to check the composition, e.g. in low-light environments.





The screen is displayed brighter than the image to be recorded, so noise may become noticeable.





- With [SET] you can change the exposure control mode that uses [Live View Boost] to display the screen.
- Noise may be more noticeable in the screen than in the recorded image.
- [Live View Boost] does not work in the following cases:
 - When adjusting the exposure (when the shutter button is pressed halfway, for example)
 - When recording a video or 4K photo
 - When using [Filter Settings]
 - When using [Constant Preview]

[Peaking]

With this item, you can have the edges of in-focus sections highlighted with color during manual focusing.

- When [Detect Level] in [SET] is set to [HIGH], sections to be highlighted are reduced, allowing you to achieve a more precise focus setting.
- Changing the [Detect Level] setting also changes the [Display Color] setting as follows.

[Detect Level]	[HIGH]	↔	[LOW]
[Display Color]	[] (Light blue)		[] (Blue)
	[] (Yellow)		[] (Orange)
	[] (Yellow-green)		[] (Green)
	[] (Pink)		[] (Red)
	[] (White)		[] (Gray)

- Each time [] in [] is touched, the setting is switched in order of [] ([Detect Level]: [LOW]) → [] ([Detect Level]: [HIGH]) → [OFF].
- [Peaking] is not available when using [Live View Boost]
- [Peaking] does not work with [Rough Monochrome] in [Filter Settings].

[Histogram]

When this item is activated, the histogram is displayed.

You can move the position by pressing ▲/▼/◀/▶.

- Direct touch operation is also possible on the recording screen.
- A histogram is a graph that displays brightness along the horizontal axis (black to white) and the number of pixels at each brightness level on the vertical axis. It allows you to easily check a picture's exposure.

- Ⓐ darker
- Ⓑ brighter

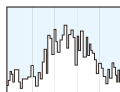

- **When the recorded picture and the histogram do not match each other under the following conditions, the histogram is displayed in orange.**

- When using Exposure Compensation
 - When a flash unit is activated
 - When the correct exposure is not achieved, such as when the lighting is low.
- The histogram is an approximation in the exposure control mode.

[Guide Line]

This item allows guide lines to be displayed in selectable patterns when taking a picture.

When [] is set, guideline positions can be moved by pressing ▲/▼/◀/▶.

- You can also set the position directly by touching [] on the guideline of the recording screen.
- Guide lines are not displayed during panorama recording.

[Center Marker]

With this item activated, the center of the recording screen will be indicated by [+].

[Highlight]

When this item is activated, totally overexposed areas flash in black and white during [Auto Review] or playback.



- If total overexposure is indicated, we recommend setting a negative exposure compensation value referring to the histogram and then taking the picture again. It may result in a picture suiting your preference better.
- The highlight display does not work in the following cases:
 - During 4K photo playback
 - During playback of images recorded with the Post Focus function
 - During Multi Playback
 - During Calendar Playback
 - During Playback Zoom

[Zebra Pattern]

This item allows you to select that subject parts which may be totally overexposed (bright parts effectively all white) are indicated by a zebra pattern.

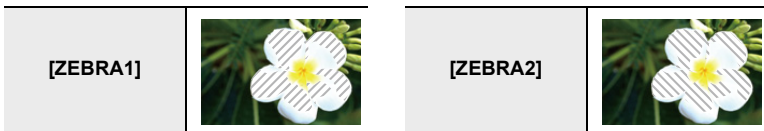

Select [SET] to set the brightness level to be indicated by a zebra pattern.

- You can select a brightness value between [50%] and [105%]. In [Zebra 2], you can select [OFF]. If you select [100%] or [105%], only the areas that are already totally overexposed are indicated by a zebra pattern. The smaller the value is, the wider the brightness range to be indicated by a zebra pattern will be.

- If there are any totally overexposed areas, we recommend setting a negative exposure compensation referring to the histogram and then taking the picture.
- Displayed zebra patterns will not be recorded.
- If you assign [Zebra Pattern] to [Fn Button Set] in the [Custom] ([Operation]) menu, each time you press the function button to which the setting is assigned, the zebra pattern toggles as follows:

[Zebra 1] → [Zebra 2] → [OFF].

If you set [Zebra 2] to [OFF], the pattern toggles in the order of [Zebra 1] → [OFF]

[Expo.Meter]

With this item you can select to display the exposure setting balance.

- Set to [ON] to display the exposure setting balance when performing Program Shift, setting aperture, and shutter speed.
- Unsuitable areas of the range are displayed in red.
- When the exposure setting balance is not displayed, switch the display information for the screen by pressing [DISP].
- If no operations are performed for approximately 4 seconds, the exposure setting balance disappears.

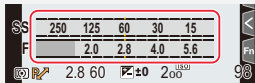
**[MF Guide]**

When you activate this mode and focus manually, an MF guide that allows you to check the direction to achieve focus is displayed.

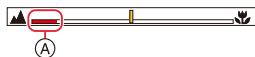



- (A) Indicator for ∞ (infinity)

[Monitor Info. Disp.]

This function is for displaying the recording information screen. (→40, 267)

[Rec Area]

With this item activated, the angle of view is changed during video and picture recording.

	Displays the recording area according to the angle of view for picture recording.
	Displays the recording area according to the angle of view for video recording.



- The recording area indicated is an approximation.

**Not available in these cases:**

- When recording with the 4K Photo function or Post Focus function, [Rec Area] is fixed to .

[Remaining Disp.]

With this item activated, the display will switch between the number of recordable pictures and the available recording time.

MENU →  **[Custom]** →  **[Lens / Others]**

[Lens Position Resume]

With this item activated, the zoom and focus positions will be resumed when you turn the camera off and back on.

[Lens Retraction]

With this item activated, the lens barrel will retract shortly after you switch to the playback screen.

[Self Timer Auto Off]

This item allows you to set that the self-timer will be canceled when the camera is turned off.

[Face Recog.]

Face Recognition is a function which finds a face resembling a registered face and prioritizes the focus and exposure settings automatically. Even if the person is located towards the back or at the end of a line in a group photo, the camera can still deliver that face sharply focused.

[ON]	Enables the Face Recognition function.
[OFF]	Disables the Face Recognition function.

Allows you to register face images, or edit or delete registered information.

Face Settings

You can register information such as names and birthdays for face images of up to 6 people.

- Press ▲/▼/◀/▶ to select the Face Recognition frame that is not registered, and then [MENU/SET].
- Take the picture adjusting the face with the guide.
 - The faces of subjects other than people (pets, etc.) cannot be registered.
 - To display the description of the face registration, press ► or touch [i].
- Set the item.
 - You can register up to 3 face images.

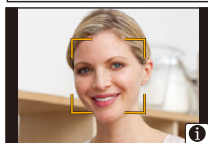
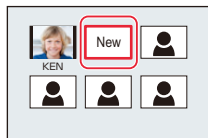
**[MEMORY]**

[Name]	Allows registering names. • For information on how to enter characters, refer to (→55).	
[Age]	Allows registering birthdays.	
[Add Images]	(Add Images)	For adding additional face images. • Select a blank face image frame to register a new image.
	(Delete)	For deleting one of the face images. • Select the face image you want to delete.

Changing or deleting the information for a registered person:

- Press ▲/▼/◀/▶ to select the face image to edit or delete and then [MENU/SET].
- Set the item.

[Info Edit]	For changing the information of an already registered person. • Perform step ③ in "Face Settings".
[Priority]	The focus and exposure settings are preferentially allocated to the faces registered as higher-priority. • Rearrange and set the face priority.
[Delete]	For deleting information of a registered person.

Tips for successfully registering face images

- Have the person face forwards with eyes open and mouth closed, making sure the outline of the face, the eyes, or the eyebrows are not covered with hair.
- Make sure there is no extreme shading on the face when registering.
(Flash will not operate during registration.)

(Good example for registering)

**When a face is not recognized during recording**

- Register the face of the same person indoors and outdoors, or with different expressions or angles.
- Additionally register at the location of recording.
- When a person who is registered is not recognized, correct by re-registering.
- Face Recognition may not be possible or may not recognize faces correctly even for registered faces, depending on the facial expression and environment.

• The following functions will also work with the Face Recognition function.**In Recording Mode**

- Display of corresponding name when camera detects a registered face*

In Playback Mode

- Display of name and age

- * Names of up to 3 people are displayed.

Precedence for the names displayed when taking pictures is determined according to the order of registration.

• [Face Recog.] only works when the AF Mode is set to [].

- The function works only when a face has been detected.
- When you specify the person to be brought into focus, [Face Recog.] will not work.
- When using Continuous mode, [Face Recog.] picture information can be attached to only the first picture.
- When group pictures are played back, the name of the first picture of the set is displayed.

**Not available in these cases:**

- [Face Recog.] does not work in the following cases:
 - When using [Miniature Effect] in [Filter Settings]
 - When recording videos
- [Face Recog.] cannot be set in the following cases:
 - When recording 4K pictures
 - When recording with the Post Focus function
 - When using [Panorama Shot]
 - When using [Time Lapse Shot]

[Profile Setup]

This function allows you to set the name and birthday of your baby or pet in advance, so you can record their name and age in months and years in the images.

You can display these at playback or stamp the recorded images using [Text Stamp].

Settings: [] ([Baby1])/[] ([Baby2])/[] ([Pet])/[OFF]/[SET]

■ **Setting [Age] or [Name]**

- 1 Press ▲/▼ to select [SET] and then [MENU/SET].
- 2 Press ▲/▼ to select [Baby1], [Baby2] or [Pet] and then [MENU/SET].
- 3 Press ▲/▼ to select [Age] or [Name] and then [MENU/SET].
- 4 Press ▲/▼ to select [SET] and then [MENU/SET].

Enter [Age] (birthday).

Enter [Name].

• For information on how to enter characters, refer to (→55).

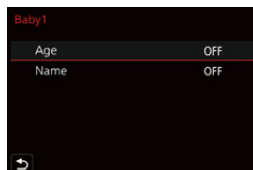

■ **To cancel the display of [Age] and [Name]**

Select [OFF] in [Profile Setup].

Not available in these cases:

- [Profile Setup] is not available when recording is performed with the 4K Photo or Post Focus function.
- Ages and names are not recorded in the following cases:
 - When recording videos
 - Pictures recorded during video recording

🔧 : [Setup] menu

- [Utilize Custom Set feature] (→70)
- [Cust.Set Mem.] (→70)
- [Clock Set] (→31)
- [World Time] (→195)
- [Travel Date] (→196)
- [Wi-Fi] (→196)
- [Bluetooth] (→197)
- [Wireless Connection Lamp] (→197)
- [Beep] (→197)
- [Economy] (→198)
- [Monitor Display Speed] (→198)
- [EVF Display Speed] (→198)
- [Monitor Display]/[Viewfinder] (→199)
- [Monitor Luminance] (→199)
- [m/ft] (→199)
- [Eye Sensor] (→200)
- [USB Mode] (→200)
- [TV Connection] (→201)
- [Language] (→201)
- [Version Disp.] (→201)
- [Folder / File Settings] (→202)
- [No.Reset] (→203)
- [Reset] (→203)
- [Reset Network Settings] (→204)
- [Level Gauge Adjust.] (→204)
- [Format] (→28)

MENU → 🔧 [Setup]

[World Time]

This item is for setting the times for the region where you live and your holiday destination.
 • [Destination] can be set after setting up [Home].

After selecting [Destination] or [Home], press ◀/▶ to select an area, and then [MENU/SET] to set.

🔧 [Destination]:

Travel destination area

- (A) Current time of the destination area
- (B) Time difference from home area

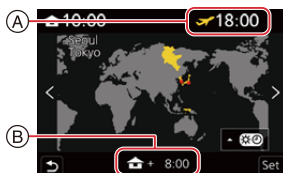

🏠 [Home]:

Your home area

- (C) Current time
- (D) Time difference from GMT (Greenwich Mean Time)



- If you are using Daylight Savings [☀️], press ▲. (The time will move forward by 1 hour.) To return to the normal time, press ▲ again.
- Set to [Home] when you have returned from your travel destination.
- If you cannot find the travel destination in the areas displayed on the screen, set by the time difference from the home area.

[Travel Date]

[Travel Setup]	This item allows you to set your travel schedule and record images, so the elapsed days (how many days after) of the travel will be recorded.
[Location]	When [Travel Setup] is set, you can set your travel destination. • For information on how to enter characters, refer to (→55).

- You can display the elapsed days and travel destination during playback or stamp them on recorded pictures in [Text Stamp].
- The travel date is calculated using the date in the clock setting and the departure date you set. If you set [World Time] to the travel destination, the travel date is calculated using the date in the clock setting and the travel destination setting.
- When [Travel Setup] is set to [OFF], the number of days elapsed is not recorded. It is not displayed even if [Travel Setup] is set to [SET] after recording.
- When the current date passes the return date, [Travel Setup] is automatically canceled.
- [Location] cannot be recorded in the following cases:
 - When recording videos
 - When recording 4K pictures
 - When recording with the Post Focus function

[Wi-Fi]

■ **[Wi-Fi Function]** (→222)

■ **[Wi-Fi Setup]** (→253)

[Bluetooth]

- [Bluetooth] (→226)
- [Remote Wakeup] (→233)
- [Returning from Sleep Mode] (→237)
- [Auto Transfer] (→239)
- [Location Logging] (→241)
- [Auto Clock Set] (→242)
- [Wi-Fi network settings]

Registers a wireless access point. (→247)

- The wireless access point used for the Wi-Fi connection is automatically registered.
- Up to 17 wireless access points can be registered. If you try to register more than 17 access points, the oldest registered access points will be deleted.
- Performing [Reset Network Settings] will delete registered wireless access points.

[Wireless Connection Lamp]

This item allows enabling/disabling the wireless connection lamp.
If you select [OFF], it will not light up/flash.

[Beep]

This item allows you to set the electronic sounds and the electronic shutter sound.

Settings: [Beep Volume]/[Shutter Vol.]/[Shutter Tone]

- [Beep] is not available when [Silent Mode] is set to [ON].

[Economy]

[Sleep Mode]	The camera is automatically turned off if it has not been used for the time selected on the setting.
[Sleep Mode(Wi-Fi)]	The camera is automatically turned off if it is not connected to a Wi-Fi network and has not been used for 15 minutes (approx.).
[Auto EVF/ Monitor Off]	The monitor/viewfinder is automatically turned off if the camera has not been used for the time selected on the setting.

- To cancel [Sleep Mode] or [Sleep Mode(Wi-Fi)], perform either of the following operations:
 - Press the shutter button halfway.
 - Turn the camera off and on.
- To turn the monitor/viewfinder on again, press any button.
- [Economy] does not work in the following cases:
 - When connecting to a computer or a printer
 - When recording or playing back videos
 - During a slide show
 - When recording with [4K Pre-Burst]
 - When recording in [Multi Exp.]
 - When using [Time Lapse Shot]
 - When using [Stop Motion Animation] (only when [Auto Shooting] is set)

[Monitor Display Speed]/[EVF Display Speed]

This item allows setting the monitor/viewfinder refresh frame rate.

[ECO30fps]	Reduces the power consumption, extending the operating time.
[60fps]	Displays movements smoother. This setting is ideal for recording fast-moving subjects.

- When [Monitor Display Speed] or [EVF Display Speed] (or both) is set to [ECO30fps], Digital Zoom is not available.
- The [Monitor Display Speed]/[EVF Display Speed] setting does not affect the recorded picture.
- Images are displayed at [60fps] in the following cases:
 - When recording 4K pictures
 - When recording with the Post Focus function

[Monitor Display]/[Viewfinder]

This item allows adjusting the brightness, color, or red or blue tint of the monitor/viewfinder.

- 1 Select the settings by pressing ▲/▼, and adjust with ◀/▶.**
- 2 Press [MENU/SET] to set.**

- When the monitor is in use, it is adjusted and the viewfinder when the viewfinder is in use.
- Some subjects may appear differently than in reality on the monitor. However, this does not affect the recorded pictures.

[Monitor Luminance]

[A* (Auto)]	The brightness is adjusted automatically depending on how bright it is around the camera.
[1* (Mode 1)]	Brightens the monitor image.
[2* (Mode 2)]	Set the monitor to the standard brightness.
[3* (Mode 3)]	Darkens the monitor image.

- Some subjects may appear differently than in reality on the monitor. However, this does not affect the recorded pictures.
- The monitor automatically returns to standard brightness if no operations are performed for 30 seconds when recording in [**1***]. It will light up brightly again with button or touch operation.
- When [**A***] or [**1***] is set, the usage time is reduced.
- [**A***] is only available in the Recording Mode.

[m/ft]



This item allows selecting how distance is displayed, in “ft” or “m”.

[Eye Sensor]

[Sensitivity]	This option is for setting the sensitivity of the eye sensor.
[EVF/Monitor Switch]	<p>This option is for setting the method for switching between the monitor and viewfinder.</p> <p>[EVF/MON AUTO] (automatic switching between the monitor and viewfinder)</p> <p>[EVF] (viewfinder)</p> <p>[MON] (monitor)</p> <ul style="list-style-type: none"> • If you press [EVF] to switch the display, the [EVF/Monitor Switch] setting will also switch.

[USB Mode]

This item allows setting the communication method when connecting using the USB cable.

 [Select on connection]	Select this option to select the USB communication system when connecting to another device.
 [PC(Storage)]	Select this option to export images to a connected computer.
 [PictBridge(PTP)]	Select this option when connecting to a printer supporting PictBridge.

[TV Connection]**[HDMI Mode (Play)]:**

This item allows setting the video format to be used for output in Playback mode when the camera and a TV or monitor is connected with an HDMI micro cable.

[AUTO]	Outputs images at an output resolution suited to the connected TV.
[4K/30p]/[1080p]/[1080i]/[720p]/[480p]	Outputs images at the selected resolution. • The output resolution for [4K/30p] is 3840×2160.

- If no image appears on your TV when [AUTO] is set, switch to a setting other than [AUTO] that can display images on the TV.

[HDTV Link]:

If you select [ON], operations of the camera and the HDTV Link compatible equipment connected to the camera with an HDMI micro cable are automatically linked, enabling you to control the camera with the remote control of the HDTV Link compatible equipment.

[Language]

This item allows setting the language displayed on the screen.

- If you set a different language by mistake, select [3] from the menu icons to set the desired language.

[Version Disp.]

This item allows checking the firmware versions of the camera.

- To display information about the software on the camera, press [MENU/SET] on the version display screen.

[Folder / File Settings]

This item allows setting the folder and file name patterns in which images are to be saved.

Folder name		File name	
①	Folder number (3-digits, 100–999)	①	Color space ([L]: sRGB, [_]: AdobeRGB)
②	5-digit user-defined segment	②	3-digit user-defined segment
		③	File number (4-digits, 0001–9999)
		④	File extension

[Select Folder]	Specifies the folder to which images are to be saved. <ul style="list-style-type: none"> The folder name is indicated with the number of files that can be stored. 	
[Create a New Folder]	[OK]	Creates a new folder with the same 5-digit user-defined segment as the current folder name setting.
	[Change]	Allows you to redefine the 5-digit user-defined segment before creating a new folder. <ul style="list-style-type: none"> Available characters: alphabet (upper case characters), numbers, and [_] For information on how to enter characters, refer to (→55).
	<ul style="list-style-type: none"> A new folder with an incremented folder number is created. If there are no recordable folders in the card, a screen for resetting the folder number is displayed. 	
[File Name Setting]	[Folder Number Link]	Uses the folder number of the folder name as the file name's 3-digit user-defined segment.
	[User Setting]	Allows you to define and set the 3-digit user-defined segment of the file name. <ul style="list-style-type: none"> Available characters: alphabet (upper case characters), numbers, and [_] For information on how to enter characters, refer to (→55).

- Each folder can store up to 1000 files.
- File numbers are assigned sequentially from 0001 to 9999 in the order of recording. If you change the storage folder, a continuing number from the last file number will be assigned.
- In the following cases, a new folder with an incremented folder number will be created automatically when the next file is saved:
 - The current folder contains 1000 files
 - The current folder contains a file with the file number “9999”
- New folders cannot be created when there are folders numbered from 100 all the way up to 999. In this case, we recommend saving their data to a computer or similar device and formatting the card.

[No.Reset]

This item allows resetting the file number of the next recording to 0001.

- When recording is performed after resetting this item, the folder number is updated and the file number starts from 0001.
- A folder number between 100 and 999 can be assigned.
The folder number should be reset before it reaches 999. We recommend formatting the card after saving the data on a computer or elsewhere.
- To reset the folder number to 100:
 - ① Perform [Format] to format the card.
 - ② Perform [No.Reset] to reset the file number.
 - ③ Select [Yes] on the folder number reset screen.

[Reset]

This item allows resetting the following settings to the default:

- Recording settings and the drive mode.
- Setup settings ([Wi-Fi Setup] and [Bluetooth] settings)
- Custom settings ([Face Recog.] and [Profile Setup] settings)
- Setup/custom settings (except for [Wi-Fi Setup], [Bluetooth], [Face Recog.] and [Profile Setup])
- When the setup/custom settings are reset, the following settings are also reset.
 - The [World Time] setting
 - The settings of [Travel Date] (departure date, return date, location)
 - The settings of [Rotate Disp.], [Picture Sort] and [Delete Confirmation] in the [Playback] menu
- Folder numbers and clock settings are not reset.
- When requesting a repair or transferring/disposing of the camera, refer to “About the personal information” on 285.

[Reset Network Settings]

This item allows the following network settings to be reset to the default:

- [Wi-Fi Setup]
- Registered device information in [Bluetooth] and values in [Wi-Fi network settings]

- When requesting a repair or transferring/disposing of the camera, refer to “About the personal information” on 285.

[Level Gauge Adjust.]

[Adjust.]	Hold the camera in a horizontal position, and press [MENU/SET]. The level gauge will be adjusted.
[Level Gauge Value Reset]	Restores the default level gauge setting.

 : [My Menu] menu**[My Menu Setting]**

For registering frequently-used menu items and displaying them in [My Menu]. You can register up to 23 menu items.

MENU → **** **[My Menu]** → **[My Menu Setting]**

[Add]	Specifies the menu item to be displayed in My Menu to register it.
[Sorting]	Rearranges the menu items displayed in My Menu. Select the menu item you want to move and set the destination.
[Delete]	Deletes registered menu items. [Delete Item]: Deletes selected menu items. [Delete All]: Deletes all of the menu items.
[Display from My Menu]	Sets the first menu to be displayed when the menu screen is displayed. [ON]: Displays My Menu. [OFF]: Displays the last-used menu.

 : **[Playback] menu**

- [Slide Show] (→206)
- [Playback Mode] (→207)
- [Protect] (→208)
- [Rating] (→208)
- [Title Edit] (→209)
- [Face Rec Edit] (→209)
- [RAW Processing] (→210)
- [4K PHOTO Bulk Saving] (→212)
- [Light Composition] (→213)
- [Sequence Composition] (→214)
- [Clear Retouch] (→215)
- [Text Stamp] (→216)
- [Resize] (→217)
- [Cropping] (→218)
- [Rotate] (→219)
- [Video Divide] (→219)
- [Time Lapse Video] (→220)
- [Stop Motion Video] (→220)
- [Rotate Disp.] (→220)
- [Picture Sort] (→221)
- [Delete Confirmation] (→221)

• The camera may not play back images recorded on other devices correctly, and the functions of the camera may not be available for the images.

■ How to select an image(s) after selecting [Single] or [Multi]

- When [Single] and [Multi] are not available, select an image in the same way as when [Single] is selected.

[Single] setting

1 Press ◀/▶ to select the picture.

2 Press [MENU/SET].

- If [Set/Cancel] is displayed at the right bottom of the screen, the setting is canceled when [MENU/SET] is pressed again.



[Multi] setting

When a screen similar to the one on the right is displayed:

1 Press ▲/▼/◀/▶ to select the picture and then [MENU/SET] (repeat).

- The setting is canceled when [MENU/SET] is pressed again.

2 Press [DISP] to execute.

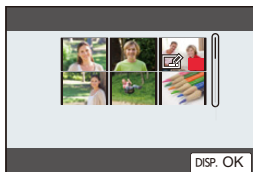

When a screen similar to the one on the right is displayed:
Press ▲/▼/◀/▶ to select the picture, and then [MENU/SET] to set (repeat).

- The setting is canceled when [MENU/SET] is pressed again.

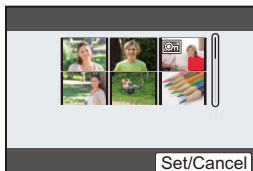

[Slide Show]

This item allows you to play back the pictures you have taken in synchronization with music, and you can do this in sequence while leaving a fixed interval between each of the pictures.

You can also put together a slide show composed of only pictures, only videos, etc.

We recommend this feature when you view your pictures by connecting the camera to a TV.





MENU →  **[Playback]** → **[Slide Show]**





1 Select the group to playback by pressing ▲/▼, and then [MENU/SET].

- If you select [Picture Only], 4K picture series files and images recorded with the Post Focus function will also be played back.
- For images recorded with the Post Focus function, only an in-focus representative image will be chosen and played back.

2 Press ▲/▼ to select [Start] and then [MENU/SET].

■ **Operations during a slide show**

Button operation	Touch operation	Description of operation
▲		Play/Pause
◀		Returns to previous picture
		Reduces the volume level

Button operation	Touch operation	Description of operation
▼		Exits the slide show
▶		Advances to the next picture
		Increases the volume level

■ Changing the slide show settings

You can change the settings for slide show playback by selecting [Effect] or [Setup] on the slide show menu screen.

[Effect]	This allows you to select the screen effects when switching from one picture to the next.	
[Setup]	[Duration]	• [Duration] can be set only when [OFF] has been selected as the [Effect] setting.
	[Repeat]	[ON]/[OFF]
	[Sound]	[AUTO]: Music is played when the pictures are played back, and audio is played when the videos are played back. [Music]: Music is played back. [Audio]: Audio (only for videos) is played back. [OFF]: There will be no sound.

- The [Effect] setting does not work while the following images are played back in a slide show:
 - 4K picture series files
 - Images recorded with the Post Focus function
 - Group pictures
- The [Duration] setting does not work while the following images are played back in a slide show:
 - Videos
 - 4K picture series files
 - Images recorded with the Post Focus function
 - Panorama pictures
 - Group pictures

[Playback Mode]

This item allows you to select Playback in [Normal Play], [Picture Only] or [Video Only].

MENU →  **[Playback]** → **[Playback Mode]**

Select the group to play back by pressing ▲/▼, and then [MENU/SET].

- If you select [Picture Only], 4K picture series files and images recorded with the Post Focus function will also be played back.

[Protect]

This item allows you to set protection for pictures you do not want to delete by mistake.

MENU →  **[Playback]** → **[Protect]**

Select the picture. (→205)

- [999+] is displayed on the screen, if the total number of protects you set for group pictures is more than 1000.

■ Canceling all the [Protect] settings

Press **▲/▼** to select **[Cancel]**, and then **[MENU/SET]**.



If you set the write-protect switch on the card to **[LOCK]**, images will not be deleted even when protection is not set for them.

- Be aware that the [Protect] setting may not work on other devices.
- Even if you protect pictures on a card, they will be deleted if the card is formatted.

[Rating]

This item allows you to set five different rating levels for images to do the following:

- Delete all unrated pictures.
- Checking the rating level on the file detail display of an operating system, such as Windows 10, Windows 8.1, or Windows 8. (JPEG images only)

MENU →  **[Playback]** → **[Rating]**

1 Select the picture. (→205)**2 Press ◀/▶ to set the rating level (1–5), and then [MENU/SET] to set.**

- When [Multi] has been selected, repeat steps **1** and **2** for each picture. (It is not possible to use the same setting for a multiple number of pictures.)
- The number of group pictures will be displayed, if you set for group pictures. [999+] is displayed, if the group of pictures contains more than 1000 pictures.

■ Canceling all the [Rating] settings

Press **▲/▼** to select **[Cancel]**, and then **[MENU/SET]**.

- [Cancel] cannot be selected when [Playback Mode] is set to [Picture Only] or [Video Only].

[Title Edit]

This item allows you to text (comments) to pictures. After text has been registered, it can be stamped in prints using [Text Stamp].

MENU →  **[Playback]** → **[Title Edit]**

1 Select the picture. (→205)

-  is displayed for pictures with titles already registered.

2 Enter the text. (→55)

- To delete the title, erase all the text in the text input screen.
- You can set up to 100 pictures at one time with [Multi].

**Not available in these cases:**

- Videos
- 4K picture series files
- Images recorded with the Post Focus function
- Images recorded with [Quality] set to [RAW $\frac{1}{2}$], [RAW $\frac{1}{4}$] or [RAW]

[Face Rec Edit]

This item allows you to clear and replace all information relating to face recognition in selected images.

MENU →  **[Playback]** → **[Face Rec Edit]**

- 1 Press ▲/▼ to select [REPLACE] or [DELETE], and then [MENU/SET].**
- 2 Press ◀/▶ to select the picture and then [MENU/SET].**
- 3 Press ◀/▶ to select the person and then [MENU/SET].**
- 4 (When [REPLACE] is selected)
Press ▲/▼/◀/▶ to select the person to replace and then [MENU/SET].**

- Cleared information regarding the [Face Recog.] cannot be restored.
- The Face Recognition information of pictures in a group has to be edited at once. (You cannot edit one picture at a time.)
- Editing of a group picture can be performed only on the first picture of each group.

[RAW Processing]

This item allows you to process the pictures taken in RAW format in the camera. The processed pictures will be saved in JPEG format.

MENU → **▶** **[Playback]** → **[RAW Processing]**

- 1 **Select RAW images with ◀/▶, and then press [MENU/SET].**
- 2 **Press ▲/▼ to select an editing parameter.**
 - You can set the following items. The settings you used for the recording are selected when you start setting these items.



[White Balance]	Allows you to select a White Balance preset and adjust it. If you select an item with [☑], you can process the image with the setting at the time of recording.
[Brightness correction]	Allows you to correct the brightness within the range between -2 EV and +2 EV.
[Photo Style]	Allows you to select a photo style effect.
[i.Dynamic]	Allows you to select an [i.Dynamic] setting.
[Contrast]	Allows you to adjust the contrast.
[Highlight]	Allows you to adjust the brightness of bright portions.
[Shadow]	Allows you to adjust the brightness of dark portions.
[Saturation]/ [Color Tone]	Allows you to adjust the saturation. (When [Monochrome], [Monochrome HC] or [Monochrome HC+] is selected in [Photo Style], you can adjust the color tone.)
[Filter Effect]	Allows you to select a filter effect. (Only when [Monochrome], [Monochrome HC] or [Monochrome HC+] is selected in [Photo Style].)
[Grain Effect]	Allows you to set the graininess. (Only when [Monochrome], [Monochrome HC] or [Monochrome HC+] is selected for [Photo Style].)
[Noise Reduction]	Allows you to adjust the noise reduction setting.
[i.Resolution]	Allows you to select an [i.Resolution] setting.
[Sharpness]	Allows you to adjust the resolution effect.
[More Settings]	Use ▲/▼ to select items and press [MENU/SET] to perform the following operations. [Reinstate Adjustments]: Returns the settings to the ones you used during the recording. [Color Space]: Allows you to select a [Color Space] setting from [sRGB] or [Adobe RGB]. [Picture Size]: Allows you to select the size in which the image will be saved in JPEG format.

3 Press [MENU/SET] and set.

- Refer to "How to set each item" on (→211).

4 Press [MENU/SET].

- This operation returns you to the screen in step **2**. To set other items, repeat steps **2** through **4**.

5 Select [Begin Processing] with ▲/▼, and then press [MENU/SET].**■ How to set each item**

Button operation	Touch operation	Description of operation
	Dragging	Selects a setting.
▲	[WB K Set]	Displays the screen that lets you set the color temperature. (only when [White Balance] is set to [K])
▼	[Adjust.]	Displays the screen that lets you fine-adjust the White Balance. (only when [White Balance] is set)
[DISP]	[DISP.]	Displays the comparison screen.
[MENU/SET]	[Set]	Sets the adjusted level and returns you to the item selection screen.

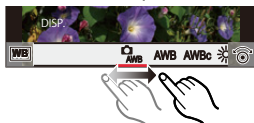

- When [Noise Reduction], [i.Resolution] or [Sharpness] is selected, the comparison screen cannot be displayed.
- Pictures can be enlarged with the zoom lever.
- Each time you touch the screen twice, the display switches between enlarged and normal view.

On the comparison screen, you can use the following operations to make adjustments:

Button operation	Touch operation	Description of operation
	Dragging	Selects a setting.
[DISP]	[DISP.]	Returns you to the setting screen.
[MENU/SET]	[Set]	Sets the adjusted level and returns you to the item selection screen.

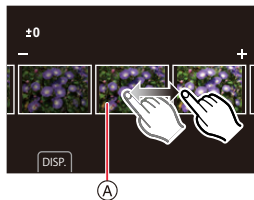

(A) Current setting

- If you touch the picture at the center, it will be enlarged. If you touch , the picture will be reduced to the original size.

- The [White Balance] setting of pictures taken with multiple exposures is fixed to the setting at the time of recording.
- Edit group images one by one. The edited images will be saved as new images separate from the original group images.



Not available in these cases:

- [RAW Processing] is not available when an HDMI micro cable is connected.
- RAW processing cannot be performed on RAW images recorded with other devices.

[4K PHOTO Bulk Saving]

This item allows you to save pictures of a 4K picture series file that were extracted from any 5 second period at once.

MENU →  **[Playback]** → **[4K PHOTO Bulk Saving]**

- 1 Press ◀/▶ to select the 4K picture series files and then [MENU/SET].**
 - If the total recording time is 5 seconds or less, all frames will be saved as pictures.
- 2 Select the first frame of the pictures to be saved at once. (→106, 107)**
 - Pictures will be saved as a group of Continuous mode pictures in JPEG format. (→163)

[Light Composition]

This function allows you to select multiple frames from 4K picture series files that you wish to merge. Parts of the image that are brighter than the preceding frame will be superimposed on the preceding frame to merge the frames into one picture.

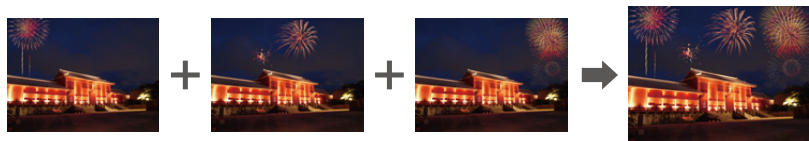

MENU → **[Playback]** → **[Light Composition]**

- 1 Press /▶ to select the 4K picture series files and then **[MENU/SET]**.
- 2 Choose the merging method, and then press **[MENU/SET]**.

[Composite Merging] setting

Select the frames you want to combine to superimpose brighter parts.

- 1 Drag the slide bar to select the desired pictures.
- 2 Press **[MENU/SET]**.
 - The selected frames are remembered, and the display switches to the preview screen.
 - Press ▲/▼ to select items and then **[MENU/SET]** to perform the following operations.

–**[Next]**:

Lets you select more frames for merging.

–**[Reselect]**:

Cancels the frame selected immediately before and lets you select a different image.

- 3 Repeat steps 1 and 2 to select more frames to merge.
 - You can select up to 40 frames.
- 4 Press ▲/▼ to select **[Save]**, and then **[MENU/SET]**.

[Range Merging] setting

Select the first and last frames to superimpose the brighter parts of the frames between them.

- 1 Select the frame of the first picture, and press **[MENU/SET]**.
 - The selection method is the same as in step 1 of **[Composite Merging]** setting.
- 2 Select the frame of the last picture, and press **[MENU/SET]**.

- 3 Select **[Yes]** at the confirmation screen, and then press **[MENU/SET]**.

- Pictures are saved in JPEG format. Recording information (Exif information) of the first frame such as shutter speed, aperture, and ISO sensitivity are also registered.



[Sequence Composition]

This item allows you to select multiple frames from a 4K picture series file to create a sequence composition of a moving subject into one picture.



MENU → **[Playback]** → **[Sequence Composition]**

- 1 Press to select the 4K picture series files and then **[MENU/SET]**.
- 2 Select frames to merge.

Select the frames so that the moving subject will not overlap on the preceding or subsequent frames. (The sequence composition may not be created properly if the subject overlaps.)

- 1 Drag the slide bar to select the desired pictures.
- 2 Press **[MENU/SET]**.
 - The selected frames are remembered, and the display goes to the preview screen.
 - Press to select items and then **[MENU/SET]** to perform the following operations.
 - **[Next]**: Lets you select more frames for merging.
 - **[Reselect]**: Cancels the frame selected immediately before and lets you select a different image.
- 3 Repeat steps 1 and 2 to select more frames to merge.
 - You can select 3 to 40 frames.
- 4 Press to select **[Save]**, and then **[MENU/SET]**.



- Pictures are saved in JPEG format. Recording information (Exif information) of the first frame such as shutter speed, aperture, and ISO sensitivity are also registered.

**Tips for [Sequence Composition]**

We recommend using a tripod to take pictures.

[Clear Retouch]

- [Clear Retouch] is a setting to be used through touch operations and automatically enables touch operation.

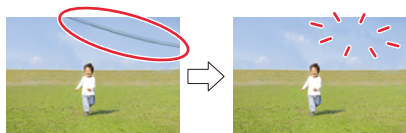

MENU → **[Playback]** → **[Clear Retouch]**

- 1 Press **◀/▶** to select a picture, and then **[MENU/SET]**.
- 2 Drag your finger over the part you want to delete.
 - The parts to be erased are colored.
 - To return the colored part back to its previous state, touch **[Undo]**.



Erasing details (enlarging the display)

- 1 Touch **[SCALING]**.
 - Pinching out/pinching in the screen allows you to enlarge/reduce it.
 - Dragging the screen allows you to move the enlarged part.
- 2 Touch **[REMOVE]**.
 - This will bring you back to the operation of dragging your finger over the part you want to delete. The part you want to delete can be dragged even while the picture is enlarged.



- 3 Touch **[Set]**.
- 4 Touch **[Save]** or press **[MENU/SET]**.

- Pictures may appear unnatural because the background of deleted parts is artificially created.
- For group pictures, perform [Clear Retouch] on each picture. (They cannot be edited at once.)
- When [Clear Retouch] is performed on group pictures, they are saved as new pictures separate from the original ones.

Not available in these cases:

- When the viewfinder display is in use
- When an HDMI micro cable is connected
- This function is not available in the following cases:
 - Videos
 - 4K picture series files
 - Images recorded with the Post Focus function
 - Panorama pictures
 - Pictures taken with **[RAW]**

[Text Stamp]

This item allows you to stamp recording information on recorded images.



MENU → **[Playback]** → **[Text Stamp]**

1 Select the picture. (→205)

- appears on screen if the picture is stamped with text.

2 Press ▲/▼ to select [Set], and then [MENU/SET].

[Shooting Date]	Stamps the recording date.
[Name]	(Face Recognition): The name registered in [Face Recog.] will be stamped. (Baby/Pet): The name registered in [Profile Setup] will be stamped.
[Location]	Stamps the travel destination name set under [Location].
[Travel Date]	Stamps the travel date set under [Travel Date].
[Title]	Title input in the [Title Edit] will be stamped.

3 Press [↶] to return to the previous screen.

4 Press ▲/▼ to select [OK], and then [MENU/SET].

- When you print pictures stamped with text, the date will be printed over the stamped text if you specify printing of the date at the photo shop or on the printer.
- You can set up to 100 pictures at one time in [Multi].
- The picture quality may deteriorate when text stamping is carried out.
- When you stamp pictures in a group, the stamped ones are saved separately from the original ones in the group.

Not available in these cases:

- Videos
- 4K picture series files
- Images recorded with the Post Focus function
- Panorama pictures
- Pictures recorded without setting the clock and title
- Pictures stamped with [Text Stamp]
- Pictures taken with [RAW]

[Resize]

This item allows you to reduce the resolution of pictures facilitating easy posting to web pages, attachment to e-mail etc.



MENU → **▶** **[Playback]** → **[Resize]**

Select the picture and resolution.

[Single] setting

- 1 Press **◀/▶** to select the picture, and then **[MENU/SET]**.
- 2 Press **▲/▼** to select the resolution, and then **[MENU/SET]**.

**[Multi] setting**

- 1 Press **▲/▼** to select the resolution, and then **[MENU/SET]**.
- 2 Press **▲/▼/◀/▶** to select the picture, and then **[MENU/SET]** to set (repeat).
 - The setting is canceled when **[MENU/SET]** is pressed again.
- 3 Press **[DISP]** to execute.

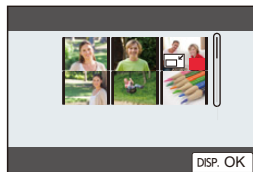

- You can set up to 100 pictures at one time in **[Multi]**.
- The picture quality of the resized picture will deteriorate.

**Not available in these cases:**

- Videos
- 4K picture series files
- Images recorded with the Post Focus function
- Panorama pictures
- Group Pictures
- Pictures stamped with **[Text Stamp]**
- Pictures taken with **[RAW]**





[Cropping]

This item allows you to enlarge and then clip the important part of the recorded picture.



MENU →  **[Playback]** → **[Cropping]**

- 1 Press /  to select the picture, and then **[MENU/SET]**.
- 2 Select the parts to be cropped.

Button operation	Touch operation	Description of operation
		Enlarges the picture
		Reduces the picture
	Drag	Moves the enlarged area

- 3 Press **[MENU/SET]**.

- The picture quality of the cropped picture will deteriorate.
- Crop one picture at a time when you want to crop the pictures in a picture group. (You cannot edit all pictures in a group at once.)
- When you crop pictures in a group, the cropped ones are saved separately from the original ones in the group.
- Information regarding the Face Recognition in the original picture will not be copied to images having undergone [Cropping].

**Not available in these cases:**

- Videos
- 4K picture series files
- Images recorded with the Post Focus function
- Panorama pictures
- Pictures stamped with [Text Stamp]
- Pictures taken with [RAW]

[Rotate] (The picture is rotated manually.)

This item allows you to rotate pictures manually in 90° steps.

- The [Rotate] function is disabled when [Rotate Disp.] is set to [OFF].

MENU →  **[Playback]** → **[Rotate]**

1 Press  **to select the picture and then [MENU/SET].**

2 Select the rotation direction.

:

The picture rotates clockwise in steps of 90°.

:

The picture rotates counter-clockwise in steps of 90°.

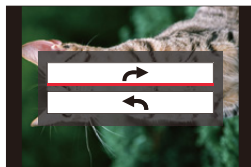
**[Video Divide]**

This item allows recorded video and 4K picture series files to be divided. It is recommended for when you want to separate a part you need from one you do not need.

Dividing a file is permanent. Decide before you divide!

MENU →  **[Playback]** → **[Video Divide]**

1 Press  **to select the file to divide, and then [MENU/SET].**

2 Press  **at the location to divide.**

- You can finely adjust the location for dividing by pressing  while the file is paused.

3 Press .

- The file may be lost if the card or battery is removed while processing the dividing.

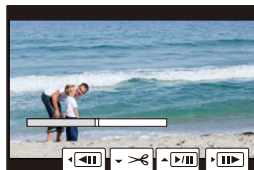



 **Not available in these cases:**

- It may not be possible to divide a file at a point near the beginning or end.
- When the recording time is short.

[Time Lapse Video]

This function allows you to create a video from a picture group recorded with [Time Lapse Shot].



MENU →  **[Playback]** → **[Time Lapse Video]**

- 1 Select the [Time Lapse Shot] picture group with  , and then press **[MENU/SET]**.
- 2 Create a video by selecting the methods for creating it.
 - Refer to (→134) for details.

[Stop Motion Video]

This item allows you to create a video from group pictures taken with [Stop Motion Animation].

MENU →  **[Playback]** → **[Stop Motion Video]**

- 1 Select the Stop Motion Animation group with  , and then press **[MENU/SET]**.
- 2 Create a video by selecting the methods for creating it.
 - Refer to (→137) for details.

[Rotate Disp.] (The picture is automatically rotated and displayed.)

This mode allows you to display pictures vertically if they were recorded holding the camera vertically.

MENU →  **[Playback]** → **[Rotate Disp.]** → **[ON]**

**Not available in these cases:**

- When you play back pictures on a computer, they cannot be displayed in the rotated direction unless the OS or software is compatible with Exif. Exif is a file format for pictures which allows recording information etc. to be added. It was established by “JEITA (Japan Electronics and Information Technology Industries Association)”.

[Picture Sort]

This item allows you to set the order in which the camera displays images during playback.

MENU →  **[Playback]** → **[Picture Sort]**

[FILE NAME]	Displays images by folder name/file name. This display format allows you to locate images in the card easily.
[DATE/TIME]	Displays images by recording date. If the card contains pictures taken with more than one camera, this display format is convenient for looking for images.

- When you insert another card, images may not be displayed by **[DATE/TIME]** first. The images will be displayed by **[DATE/TIME]** if you wait for a while.

[Delete Confirmation]

This item allows you to set which option, **[Yes]** or **[No]**, will be highlighted first when the confirmation screen for deleting a picture is displayed. It is set to **[“No” first]** at the time of purchase.

MENU →  **[Playback]** → **[Delete Confirmation]**

[“Yes” first]	[Yes] is highlighted first, so deletion can be done quickly.
[“No” first]	[No] is highlighted first. Accidental deletion of pictures is avoided.

What You Can Do with the Wi-Fi®/Bluetooth® Function

Operating the camera by connecting it to a Smartphone (→233)

- Recording with a smartphone (→234)
- Playing back or saving images stored on the camera, or uploading them on social media sites (→238)



Connect to a smartphone that supports Bluetooth low energy to expand the scope of applications

- Pairing (connection setup) (→226)
- Turning on/off the camera using a smartphone (→233)
- [B] (Bulb) recording (→236)
- Transferring recorded images to a smartphone automatically (→239)
- Writing location information of a smartphone on a recorded image (→241)
- Synchronizing the camera's clock with a smartphone (→242)



These instructions refer to both smartphones and tablets as smartphones from this point on unless noted otherwise.

Wi-Fi function/Bluetooth function

■ Before Use

• Set the clock. (→31)

- To use the Wi-Fi function on the camera, a wireless access point or a destination device equipped with the wireless LAN function is required.

■ About the WIRELESS connection lamp

Lit blue	When the Wi-Fi/Bluetooth function is turned on or connected
Flashing blue	When sending image data by operating the camera

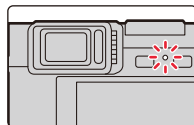

- In [Wireless Connection Lamp] in the [Setup] menu, you can set the lamp so that it will not light up/flash. (→197)

■ About the [Wi-Fi] button

In these instructions, a function button to which [Wi-Fi] is assigned is referred to as the [Wi-Fi] button.

(By default, [Wi-Fi] is assigned to [Fn6] when the camera is in Recording mode, and to [Fn1] when the camera is in Playback mode.)

- For information about the function button, refer to (→49).

Steps for pressing [Wi-Fi] (in Recording mode)

1 Touch [Fn6].



2 Touch [Fn6].



■ Operations that can be performed by pressing [Wi-Fi]

When the camera is not connected to Wi-Fi, press [Wi-Fi]. The camera will then be ready to be connected to the smartphone. You can connect the camera directly to the smartphone. (→230)

- When the camera is ready, you may find it convenient to press [DISP] to access History, which stores previous connections, and connect quickly. (→251)

After connecting to a Wi-Fi network, you can perform the following operations by pressing [Wi-Fi]:

[Terminate the Connection]	Terminates the Wi-Fi connection.
[Change the Destination]	Terminates the Wi-Fi connection, and allows you to select a different one.
[Change Settings for Sending Images]	Refer to (→246) for details.
[Register the Current Destination to Favorite]	After registering the current connection destination or the connection method, you can easily connect with the same connection method next time.
[Network Address]	(→253)

- Depending on the Wi-Fi function being used or the connection destination, you may not be able to perform some of these operations.

■ Describing method

When “select [Select a destination from History]”, etc. is described in a step, perform any of the following operations.

Button operation: Select [Select a destination from History] with the cursor buttons, and then press [MENU/SET].

Touch operation: Touch [Select a destination from History].

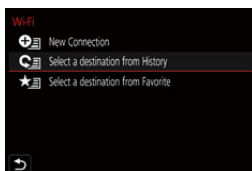

• Do not remove the card or battery or move to an area without any reception while sending images.

- The camera cannot be used to connect to a public wireless LAN connection.
- It is recommended to use a fully charged battery when sending images.
- When sending images on a mobile network, high packet communication fees may be incurred depending on the details of your contract.
- Pictures may not be completely sent depending on transmission conditions. If the connection is terminated while sending pictures, pictures with missing sections may be sent.



Connecting to a smartphone

You can remote control the camera using a smartphone.

The “Leica FOTOS” app must be installed on your smartphone.

Installing the smartphone/tablet “Leica FOTOS” app

The “Leica FOTOS” app is an application provided by Leica Camera AG that allows your smartphone to perform the following operations of a Wi-Fi-compatible Leica compact digital camera.

	For Android™ apps	For iOS apps
Supported OS	Android 6.0 or later (Android 6.0 or higher is required to use the Bluetooth function)	iOS 11.0 or later (The Bluetooth function cannot be used with the iPad 2)
Installation procedure	<ol style="list-style-type: none"> ① Connect your Android device to a network ② Select “Google Play™ Store”* ③ Enter “Leica FOTOS” into the search box ④ Select “Leica FOTOS” and install it <ul style="list-style-type: none"> • The icon will be added to the menu.  <p>* Not available in China. To download in China, please visit the site below: www.leica-camera.com</p>	<ol style="list-style-type: none"> ① Connect the iOS device to the network ② Select “App Store” ③ Enter “Leica FOTOS” into the search box ④ Select “Leica FOTOS” and install it <ul style="list-style-type: none"> • The icon will be added to the menu. 

- Use the latest version.
- Supported OSs are current as of October 2018 and are subject to change.
- The service may not be able to be used properly depending on the type of smartphone being used.
- When downloading the app on a mobile network, high packet communication fees may be incurred depending on the details of your contract.
- Some of the screens and information provided in these instructions may differ from your device depending on the supported OS and “Leica FOTOS” version.

Connecting the camera to a smartphone compatible with Bluetooth Low Energy

You can connect the camera to a smartphone via a Bluetooth connection.

• Supported smartphones

Android: Android 5.0 or higher equipped with Bluetooth 4.0 or higher (excluding those that do not support Bluetooth low energy)

iOS: iOS 9.0 or higher (excluding the iPad 2)

■ Connecting for the first time

Pairing needs to be set up only for the first connection. After pairing is set up, a Wi-Fi connection will be made automatically.

(On the camera)

MENU →  **[Setup]** → **[Bluetooth]** → **[Bluetooth]** → **[SET]** → **[Pairing]**

- The camera enters pairing standby mode and displays its device name.

(On your smartphone)

1 Start the “Leica FOTOS” app.

- If a message is displayed indicating that the smartphone is searching for cameras, close the message.

2 Select **[Bluetooth]**.

3 Turn on Bluetooth.

4 Select the device name displayed on the camera’s screen from the **[Camera enable to be registered]** list.

- A Bluetooth connection between the camera and the smartphone will be made.
(For Android devices) A Wi-Fi connection will be made by selecting **[Connection]**.

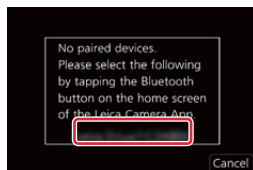

If you are using an Android device, follow the steps up to here to complete the setup. Proceed to the steps below only if you are using an iOS device (iPhone/iPod touch/iPad).

- If **[Wi-Fi Password]** (→253) is set to **[ON]** on the camera, you need to install the profile. (At the time of purchase, **[Wi-Fi Password]** is set to **[ON]**)
- If **[Wi-Fi Password]** is set to **[OFF]** on the camera, select **[Wi-Fi Setup]**.

1 Install the profile.

- If a pass code is set on the smartphone, you need to enter it.

2 Press the home button to close the browser.

5 Turn on the Wi-Fi function in the smartphone’s setting menu.

6 On the Wi-Fi setting screen, select the SSID displayed on the camera. (the device name selected in step 4)

- If the SSID is not displayed, it may be displayed after the Wi-Fi function is turned off and on.
- When you need to change the connected device, follow the on-screen message to change the setting.

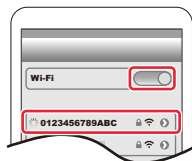

7 Start the “Leica FOTOS” app.

- The paired smartphone will be registered as a paired device after connected via Wi-Fi.

■ Connecting to the paired smartphone (connecting for the second and subsequent times)

(On the camera)

MENU → ↗ [Setup] → [Bluetooth] → [Bluetooth] → [ON]

(On your smartphone)

1 Start the “Leica FOTOS” app.

- If a message is displayed indicating that the smartphone is searching for cameras, close the message.

2 Select [Bluetooth].

3 Turn on the Bluetooth.

4 Select the camera (device name) you want to connect to from the [Camera registered] list.

- Even if you set up pairing with more than one smartphone, you can only connect to one smartphone at a time.

■ Terminating the Bluetooth connection

MENU → ↗ [Setup] → [Bluetooth] → [Bluetooth] → [OFF]

- The connection will be terminated and the camera’s Bluetooth function will be deactivated.
- Even if you terminate the connection, the pairing information for it will not be deleted.

■ Deleting pairing information

(On the camera)



1 Select the menu item.

MENU → ↗ [Setup] → [Bluetooth] → [Bluetooth] → [SET] → [Delete]

2 Select the smartphone you want to delete.

(On your smartphone)

Select the camera (device name) for which to delete the pairing information from the [Camera registered] list, and delete the registration.

- [] is displayed on the recording screen during Bluetooth connection. When the Bluetooth function is enabled, but a connection is not established, [] appears translucent.
- When it takes time to set up pairing between a smartphone and a camera, delete the pairing information of both devices and register them again. This may enable the devices to be recognized properly.
- Up to 16 smartphones can be registered. If you try to register more than 16 devices, the smartphone with the oldest registration history will be replaced.
- Performing [Reset Network Settings] will delete registered device information.

Connecting the camera to a smartphone that does not support for Bluetooth Low Energy

Connect to a smartphone via Wi-Fi.

- You can also connect via Wi-Fi to a smartphone that supports Bluetooth Low Energy by following the same steps.

Using a password to set up a connection

When [Wi-Fi Password] is set to [ON], you can enhance security by using manual entry or a QR code for password authentication.

([Wi-Fi Password] is set to [ON] at the time of purchase.)

■ Using the QR code to set up a connection (On the camera)

MENU → ↗ [Setup] → [Wi-Fi] → [Wi-Fi Function] → [New Connection] → [Remote Shooting & View]

- Ⓐ SSID and password
- Ⓑ QR code

- The information (QR Code, SSID and Password) required for directly connecting your smartphone to this camera is displayed.
- You can also display the information by pressing [Wi-Fi] on the camera.

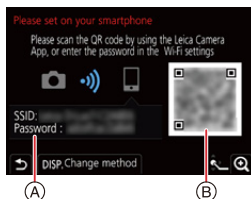

(On your smartphone)

- 1 Start the "Leica FOTOS" app.
- 2 Select [QR code].
 - When the smartphone is connected to a wireless access point, it may take time to display [QR code].
 - (For iOS devices) A confirmation screen will be displayed. Select [OK] to proceed.
- 3 Use the "Leica FOTOS" app to scan the QR code displayed on the screen of the camera.
 - To enlarge the QR code, press [MENU/SET] on the camera.

If you are using an Android device, follow the steps up to here to complete the setup. Proceed to the steps below only if you are using an iOS device (iPhone/iPod touch/iPad).

- 4 Install the profile.
 - If a pass code is set on the smartphone, you need to enter it.
- 5 Press the home button to close the browser.
- 6 Turn on the Wi-Fi function in the smartphone's setting menu.
- 7 On the Wi-Fi setting screen, select the SSID displayed on the camera.
- 8 Start the "Leica FOTOS" app.
 - (iOS devices) Steps 1 through 5 are not required from the second time on.

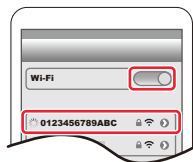

■ Manually entering a password to set up a connection

(On the camera)

MENU → ↗ **[Setup]** → **[Wi-Fi]** → **[Wi-Fi Function]** →
[New Connection] → **[Remote Shooting & View]**

Ⓐ SSID and password

Ⓑ QR code

• The information (QR Code, SSID and Password) required for directly connecting your smartphone to this camera is displayed.

• You can also display the information by pressing [Wi-Fi] on the camera.

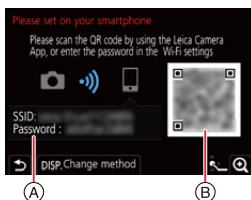

(On your smartphone)

- 1 Turn on the Wi-Fi function in the smartphone's setting menu.
- 2 On the Wi-Fi setting screen, select the SSID displayed on the camera.
- 3 Enter the password displayed on the camera into the smartphone. (For first time connection only)
- 4 Start the "Leica FOTOS" app.

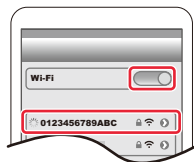

Connecting without using the password

You can easily establish a Wi-Fi connection on this camera without entering a password on your smartphone.

Preparation

On the camera, set [Wi-Fi Password] to [OFF]. (→253)

(On the camera)

MENU → ↗ **[Setup]** → **[Wi-Fi]** → **[Wi-Fi Function]** → **[New Connection]** → **[Remote Shooting & View]**

Ⓐ SSID

- The information required for directly connecting your smartphone to this camera (SSID) is displayed.
- You can also display the information by pressing [Wi-Fi] on the camera.



(On your smartphone)

- 1 Turn on the Wi-Fi function in the setup menu.
- 2 On the Wi-Fi setting screen, select the SSID displayed on the camera.
- 3 Start the “Leica FOTOS” app.
 - When the connection confirmation screen is displayed on the camera, select [Yes] to connect. (For first time connection only)

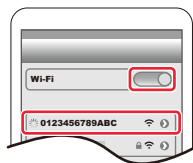

When [Wi-Fi Password] is set to [OFF].

Before connecting to a Wi-Fi network, ensure that the device displayed on the connection confirmation screen is the one you actually want to connect to. When a wrong device is displayed, if you select [Yes], the camera will automatically connect to that device. We recommend that you set [Wi-Fi Password] (→253) to [ON] if, for example, there is another Wi-Fi device nearby.

Changing the Wi-Fi connection method

To change the connection method, follow the steps below:

MENU → ↗ [Setup] → [Wi-Fi] → [Wi-Fi Function] → [New Connection] → [Remote Shooting & View] → [DISP] button

or

Wi-Fi → [DISP] button → [New Connection] → [Remote Shooting & View] → [DISP] button

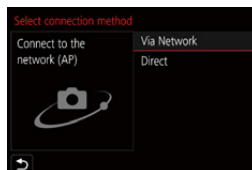

■ When connecting via a wireless access point ([Via Network]):

(On the camera)

- 1 Select [Via Network].
 - Follow the connection procedure described on (→248) to connect the camera to a wireless access point.

(On your smartphone)

- 2 Turn on the Wi-Fi function in the smartphone's setting menu.
- 3 Connect the smartphone to the wireless access point to which the camera is connected.
- 4 Start the "Leica FOTOS" app.

■ When directly connecting the camera and smartphone ([Direct]):

(On the camera)

- 1 Select [Direct].
 - Follow the connection procedure described on (→250) to connect the camera to the smartphone.

(On your smartphone)

- 2 Start the "Leica FOTOS" app.

Terminating the Wi-Fi connection

1 Set the camera to Recording mode.

- Press the shutter button halfway to return to recording mode.

2 Select the camera's menu items to terminate the Wi-Fi connection.

MENU →  [Setup] → [Wi-Fi] → [Wi-Fi Function]
→ [Yes]

- You can also terminate the connection by pressing [Wi-Fi] on the camera.

3 On the smartphone, close the “Leica FOTOS” app.



- When recording with [4K Pre-Burst] with the smartphone, terminate the connection only after switching to 4K serial recording by pressing [] on the camera.

Operating the Camera with a Smartphone

■ Required wireless connectivity mode

The wireless connectivity mode required varies depending on the function to be used after connecting to a smartphone.

Wireless connectivity required	Support for Bluetooth low energy
Bluetooth	Indicates that the function can be used with smartphones that support Bluetooth Low Energy.
Wi-Fi	Indicates that the function can be used with smartphones that do not support Bluetooth Low Energy.
Bluetooth Wi-Fi	Indicates that the function can be used with smartphones that support Bluetooth Low Energy. • Indicates that the function requires you to connect to a smartphone using both Bluetooth and Wi-Fi.

Turning on/off the camera with a smartphone

Wireless connectivity required: **Bluetooth** Wi-Fi

Even when the camera is turned off, it can be started up remotely and operated from your smartphone. You can turn on the camera to record from a remote location or view images even when the camera is in your bag.



- 1 Make a Bluetooth connection to the smartphone. (→226)
- 2 Select the camera's menu.

MENU → ↗ [Setup] → [Bluetooth] → [Remote Wakeup] → [ON]

- 3 Set the camera on/off switch to [OFF].
- 4 On the smartphone, start up the "Leica FOTOS" app, and set the Bluetooth function to a state in which a connection can be made (standby state).
- 5 Operate the smartphone.

① Select [🏠].

② Select [Remote operation].



- The camera automatically turns on, allowing it to make a Wi-Fi connection automatically.
 - (iOS devices) Depending on the connection status of the smartphone, you may need to change the connected device on the Wi-Fi setup screen. Follow the on-screen message on the smartphone to change the setting.

■ Turning off the camera with the smartphone

- 1 Select [].
- 2 Select [ OFF].

• When [Remote Wakeup] is set to [ON], the Bluetooth function continues to operate even after the camera is turned off, thus causing the battery to drain.

Taking images via a smartphone (remote recording)

Wireless connectivity required: Wi-Fi

- 1 **Connect to a smartphone.** (→225)
- 2 **Operate the smartphone.**

If the camera is already connected to the smartphone via Bluetooth, select [] → [Remote operation].

(iOS devices)



Depending on the connection status of the smartphone, you may need to change the connected device on the Wi-Fi setup screen. Follow the on-screen message on the smartphone to change the setting.

- 1 Select [].
- 2 Record an image.
 - The recorded images are saved in the camera.
 - Some settings are not available.



■ Setting the higher priority between the camera and smartphone to perform operations

MENU →  **[Setup]** → **[Wi-Fi]** → **[Wi-Fi Setup]** → **[Priority of Remote Device]**

 [Camera]	<p>Allows you to perform operations with both the camera and the smartphone.</p> <ul style="list-style-type: none"> • The camera's dial settings, etc. cannot be changed with the smartphone.
 [Smartphone]	<p>Allows you to perform operations only with the smartphone.</p> <ul style="list-style-type: none"> • The camera's dial settings, etc. can be changed with the smartphone. • To end remote recording, press any of the buttons on the camera to turn on the screen, and select [End].

- The setting of this function cannot be changed while the connection is active.

- The camera could tilt when the lens barrel extends. Make sure to secure the camera in place with a tripod or by other means.



Not available in these cases:

- In the following cases, remote recording does not work:
 - Panorama Shot mode*
 - When using [Time Lapse Shot]
- * When [Priority of Remote Device] is set to [] ([Smartphone]), you can temporarily switch to Program mode for remote recording. The camera returns to normal operation after the remote recording has finished.

Operating the shutter button with a smartphone via a Bluetooth connection alone

Wireless connectivity required: **Bluetooth**

- 1 Make a Bluetooth connection to the smartphone. (→226)
- 2 Operate the smartphone.

① Select [].

② Select [Shutter Remote Control].



③ Take pictures.

- [Shutter Remote Control] is available when the camera on/off switch is set to [ON].
- The monitor screen image of the camera is not available on the smartphone.

- When the camera turns off after [Sleep Mode] is activated during recording, you can reselect [Shutter Remote Control] on the smartphone to turn it on again. (The following settings are required.)

– [Remote Wakeup]: [ON]

– [Auto Transfer]: [OFF]

About [B] (Bulb)

When you set the shutter speed to [T] (Time), the shutter stays open after the shutter button is pressed fully (up to approximately 29 minutes).

The shutter will close when the shutter button is pressed again.



Use this when you want to keep the shutter open for a long time to take pictures of fireworks, a night scene etc.



Operate the smartphone

① Press [] to start recording (Press and hold [])

② Release your finger from [] to end recording

- Slide [] in the direction of [LOCK] to record with the shutter button fixed in the fully pressed condition. (Slide [] back in the opposite direction or press the shutter button of the camera to end recording.)
- If Bluetooth is disconnected during the [B] (Bulb) recording, reconnect Bluetooth and perform the operation to end recording using the smartphone.
- [T] (Time) will be displayed on the camera screen.



■ Reducing the time to recover from [Sleep Mode]

Select the smartphone function to be used as a priority function when waking the camera from [Sleep Mode] with a smartphone.

Preparation:

Set [Bluetooth] and [Remote Wakeup] to [ON]. (→233)

MENU →  **[Setup]** → **[Bluetooth]** → **[Returning from Sleep Mode]**

 [Remote / Transfer Priority]	Shortens the time required to wake the camera with [Remote operation] or [Transfer image].
 [Shutter Remote Priority]	Shortens the time required to wake the camera with [Shutter Remote Control].

Playing back/saving images stored on the camera, or uploading them on social media sites

Wireless connectivity required: Wi-Fi

- 1 Connect to a smartphone. (→225)
- 2 Operate the smartphone.

If the camera is already connected to the smartphone via Bluetooth, select [] → [Remote operation].

(iOS devices)

Depending on the connection status of the smartphone, you may need to change the connected device on the Wi-Fi setup screen. Follow the on-screen message on the smartphone to change the setting.

- 1 Select [].

- You can switch the images to be displayed by selecting the icon (A) on the top left of the screen. To display images stored in the camera, select [Leica].

(To play back the image)

- 2 Touch the image to enlarge it.

- When you play a video, image quality differs from that of the actual recorded one. In addition, depending on the smartphone or conditions of use, the image quality may deteriorate or the sound may skip during video or picture playback.

(To save the image or upload it on a social media site or other web service)*

- * For iOS devices, you can save a picture only to the smartphone.

- 3 Touch and hold and then drag the image.

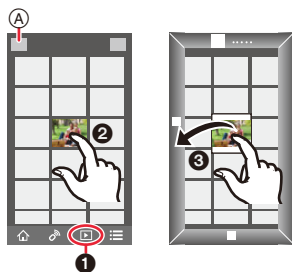

- An OS version of Android 7.0 or higher or iOS 10.0 or higher is required to save pictures in RAW format.
- Depending on the smartphone or its OS version, pictures in RAW format may not be displayed correctly.
- You cannot save the following types of images:
 - Videos in the 4K format
 - 4K picture series files
 - Images recorded with the Post Focus function



Transferring recorded images to a smartphone automatically

Wireless connectivity required: **Bluetooth** **Wi-Fi**

The camera automatically transfers recorded images to a Bluetooth-connected smartphone via Wi-Fi.

- 1 Make a Bluetooth connection to the smartphone. (→226)**
- 2 Select the camera's menu.**

MENU →  **[Setup]** → **[Bluetooth]** → **[Auto Transfer]** → **[ON]**

- If a confirmation screen is displayed on the camera asking you to terminate the Wi-Fi connection, select [Yes] to terminate it.
- 3 On the smartphone, select [Yes] (Android devices) or [Wi-Fi Setup] (iOS devices).**
 - The camera automatically makes a Wi-Fi connection.
 - (iOS devices) Follow the on-screen message on the smartphone to change the connected device on the Wi-Fi setup screen.
 - 4 Check the send settings on the camera, and select [Set].**
 - To change the send setting, press [DISP]. (→246)
 - The camera will enter a mode where it can automatically transfer images and  will be displayed on the recording screen. (If it is not displayed, images cannot be transferred automatically. Check the status of the Wi-Fi connection to the smartphone.)
 - 5 Take pictures on the camera.**
 - Every time you take a picture, it is automatically sent to a specified device.
 - While sending a file,  is displayed on the recording screen.



If you set [Auto Transfer] to [ON], the camera and the smartphone will be connected via Wi-Fi/Bluetooth and automatic transfer will be enabled the next time you turn on the camera and start the “Leica FOTOS” app on the smartphone.

■ To stop the automatic transfer of images

Select [OFF] in step 2.

- A confirmation screen is displayed, asking you to terminate the Wi-Fi connection.

- **When [Auto Transfer] is set to [ON], [Wi-Fi Function] in [Wi-Fi] in the [Setup] menu cannot be used.**
- If the camera turns off during image transfer and the file transfer is canceled, it will resend the files as soon as it is turned on again.
 - You may not be able to resend the files that did not get delivered if there is a change in their storage status. For example, if you replace the card before turning on the camera again, the files may not be resent.
 - If the number of files that did not get delivered is large, it may not be possible to resend all of the files.
- An OS version of Android 7.0 or higher or iOS 10.0 or higher is required to save pictures in RAW format.
- Depending on the smartphone or its OS version, pictures in RAW format may not be displayed correctly.
- You cannot automatically transfer the following types of images:
 - Videos
 - 4K picture series files
 - Images recorded with the Post Focus function

Writing location information of a smartphone on a recorded image

Wireless connectivity required: **Bluetooth**

The smartphone sends its location information to the camera via Bluetooth, and the camera performs recording while writing the acquired location information.

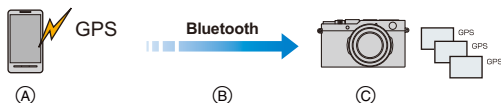

- (A) The smartphone acquires location information.
- (B) The smartphone sends the location information.
- (C) The camera performs recording while writing the location information.

Preparations:

Enable the GPS function on the smartphone.

- 1 **Make a Bluetooth connection to the smartphone.** (→226)
- 2 **Select the camera's menu.**

MENU → [Setup] → [Bluetooth] → [Location Logging] → [ON]

- The camera will enter a mode where location information can be recorded and [GPS] will be displayed on the recording screen.
- 3 **Take pictures on the camera.**
 - Location information will be written to the recorded pictures.

When [GPS] appears translucent

Location information is not acquired, so data cannot be written. Positioning with GPS on the smartphone may not be possible if it is in a location such as a building or a bag.

- Move the smartphone to a location where positioning performance can be optimized, such as one that offers a wide view of the sky, to try positioning.
- Refer to the instructions of your smartphone.

- Images with location information are indicated with [GPS].
- The smartphone drains its battery faster while acquiring location information.
- **Be sure to pay special attention to the privacy, i.e. personal rights, etc. of the subject when you use this function. Use at your own risk.**

Synchronizing the camera's clock with a smartphone

Wireless connectivity required: **Bluetooth**

Synchronize the [Clock Set] setting and the [Home] or [Destination] setting in [World Time], which are all located in the [Setup] menu of the camera, with the corresponding settings of a smartphone.

- 1 **Make a Bluetooth connection to the smartphone. (→226)**
- 2 **Select the camera's menu.**

MENU → ↗ [Setup] → [Bluetooth] → [Auto Clock Set] → [ON]

Sending Images

When sending pictures, first select [New Connection], then select the method of sending pictures.

MENU →  [Setup] → [Wi-Fi] → [Wi-Fi Function] → [New Connection] → [Send Images While Recording] or [Send Images Stored in the Camera]

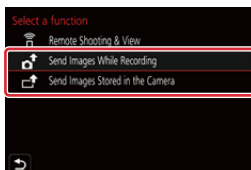

■ Images that can be sent

JPEG	RAW ^{*2}	MP4 ^{*1,3}	4K Picture Series File ^{*1} Images recorded with the Post Focus function ^{*1}
○	○	○	—

*1 Sending by [Send Images While Recording] is not available.

*2 An OS version of Android 7.0 or higher or iOS 10.0 or higher is required.

*3 Excluding 4K videos

- Some images may not be played back or sent depending on the device.
- For details about playback of images, refer to the instructions for the destination device.

Preparations:

- Install the “Leica FOTOS” app in advance. (→225)

1 Select the menu item.

MENU → ↗ [Setup] → [Wi-Fi] → [Wi-Fi Function] → [New Connection] → [Send Images While Recording] or [Send Images Stored in the Camera]

2 Select [Via Network] or [Direct], and connect. (→247, 250)

(On your smartphone)

When connecting with [Via Network]:

- 1 Turn on the Wi-Fi function.
- 2 Select the wireless access point.
- 3 Start the “Leica FOTOS” app.

When connecting with [WPS Connection] in [Direct]:

- 1 Start the “Leica FOTOS” app.

When connecting with [Manual Connection] in [Direct]:

- 1 Turn on the Wi-Fi function.
- 2 Select the SSID that matches the one displayed on the screen of this camera.
- 3 Start the “Leica FOTOS” app.

3 Select a device you want to connect.

4 Check the send settings, and select [Set].

- To change the send setting, press [DISP]. (→246)

5 When [Send Images While Recording] has been selected

Take pictures. (→245)

When [Send Images Stored in the Camera] has been selected

Select the picture. (→245)



Not available in these cases:

- When [Auto Transfer] in [Bluetooth] is set to [ON], [Wi-Fi Function] is not available.

■ Sending pictures while recording

A picture can be automatically sent to a specified device every time you take one.

- While sending a file, [📷] is displayed on the recording screen.
- Set the menu to terminate the connection.

MENU → ⚙ [Setup] → [Wi-Fi] → [Wi-Fi Function] → [Yes]

- You cannot change the sending settings while sending pictures.

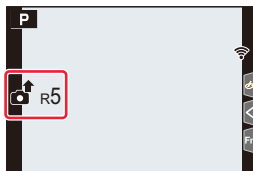

- Since the camera gives priority to recording, sending may take longer during the recording.
- If you turn off the camera or terminate the Wi-Fi connection before the transmission is completed, unsent files will not be resent.
- You may not be able to delete files or use the playback menu while sending.



Not available in these cases:

- If you set [Time Lapse Shot], the Wi-Fi connection is terminated and you cannot use this function.

■ Sending pictures stored in the camera

Pictures can be selected and sent after recording.

[Single Select] setting

- 1 Select the picture.
- 2 Select [Set].



[Multi Select] setting

- 1 Select the picture. (repeat)
 - The setting is canceled when the picture is selected again.
- 2 Select [OK].
 - To close the connection, select [Exit].

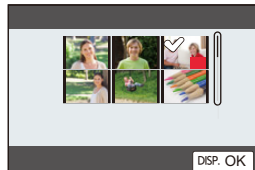

Not available in these cases:

- It may not be possible to send pictures recorded with another device and those modified or edited on a computer.

■ Changing the settings for sending images

After the connection is established, you can change the send settings by pressing [DISP].

[Size]	Resize the image to send. [Original]/[Auto]/[Change] ([M], [S] or [VGA]) • You can set this to [Auto] if the destination is [Web service]. It changes the resolution according to the status of the destination.
[File Format]	[JPG]/[RAW+JPG]/[RAW]

About Wi-Fi Connections

The following types of connections are available.

MENU → ↗ **[Setup]** → **[Wi-Fi]** → **[Wi-Fi Function]**

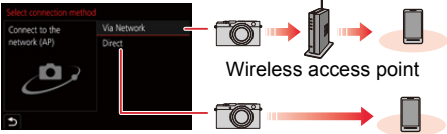
<p>[New Connection]</p>	<p>This makes a connection after a Wi-Fi function and sending destination is selected. When a screen similar to the one below is displayed, select the connection method.</p>  <p>The diagram shows two connection paths. The top path, labeled 'Via Network', shows a camera connected to a wireless access point (a tower with an antenna), which is then connected to a smartphone. The bottom path, labeled 'Direct', shows a camera connected directly to a smartphone. Red arrows indicate the direction of data flow in both cases.</p> <ul style="list-style-type: none"> • [Via Network] (→248): Makes a connection via a wireless access point. • [Direct] (→250): Connects your device and the camera directly.
<p>[Select a destination from History]/[Select a destination from Favorite]</p>	<p>The connection is made using the same settings as the previous time. (→251)</p>

Connecting via a wireless access point ([Via Network])

Select a connection method to the wireless access point.

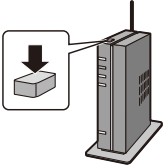
<p>[WPS (Push-Button)]</p>	<p>For saving a push button type wireless access point that is compatible with Wi-Fi Protected Setup™ with a WPS mark.</p> <p>Press the wireless access point WPS button until it switches to WPS mode. e.g.:</p> 
<p>[WPS (PIN code)]</p>	<p>For registering a PIN code type wireless access point with a WPS mark that supports Wi-Fi Protected Setup.</p> <ol style="list-style-type: none"> 1 Select the wireless access point on the camera. 2 Enter the PIN code displayed on the camera screen into the wireless access point. 3 Press [MENU/SET] of the camera.
<p>[From List]</p>	<p>Select this option when you are not sure about the WPS compatibility, or when you want to search for and connect to a wireless access point. (→249)</p>

- Except for the first-time connection, the camera will connect to the previously-used wireless access point.

To change the connection destination, press [DISP].

- WPS refers to a function that allows you to easily configure the settings related to the connection and security of wireless LAN devices.

Refer to the instructions for the wireless access point for details about how to operate the WPS function and whether it is supported.

If you are not sure about the WPS compatibility ([From List])

Search for available wireless access points.

- Confirm the encryption key of the wireless access point if the network authentication is encrypted.

1 Select the wireless access point.

- To search for wireless access points again, press [DISP].
- If no wireless access point is found, refer to “When connecting with [Manual Input]” on (→249).

2 (If network authentication is encrypted) Enter the encryption key.

- For information on how to enter characters, refer to (→55).

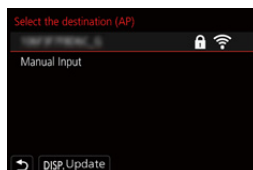
**■ When connecting with [Manual Input]**

- Check the SSID, authentication type, encryption type, and encryption key of the wireless access point to be connected.

- 1 On the screen displayed in step 1 of “If you are not sure about the WPS compatibility ([From List])”, select [Manual Input].
- 2 Enter the SSID of the wireless access point you are connecting to, then select [Set].
 - For information on how to enter characters, refer to (→55).
- 3 Select the network authentication type.

[WPA2-PSK]	Supported encryption methods: [TKIP], [AES]
[WPA2/WPA-PSK]	
[No Encryption]	—

- 4 (When an option other than [No Encryption] is selected)
Enter the encryption key.

- Check the wireless access points' instructions and settings when saving a wireless access point.
- If no connection can be established, the wireless access point's transmission may be too weak.
Refer to “Message Displays” (→270) and “Troubleshooting” (→272) for details.
- Depending on your environment, transmission speed between the camera and wireless access point may decrease. In addition, the wireless access point may not be available for use.

Connecting the camera and another device directly ([Direct])

<p>[WPS Connection]</p>	<p>[WPS (Push-Button)]</p> <ol style="list-style-type: none"> 1 On the camera, select [WPS (Push-Button)]. 2 Set the device to WPS mode. <ul style="list-style-type: none"> • You can wait longer for a connection by pressing [DISP] on this camera. <hr/> <p>[WPS (PIN code)]</p> <ol style="list-style-type: none"> 1 On the camera, select [WPS (PIN code)]. 2 Enter the PIN code of the device into this camera.
<p>[Manual Connection]</p>	<p>Enter the SSID and password displayed on the camera.</p> <ul style="list-style-type: none"> • When [Wi-Fi Password] is set to [OFF], the password is not displayed. Select the SSID to establish a connection. (→230) <div data-bbox="692 404 961 585" style="border: 1px solid black; padding: 5px;"> <p>The image shows a smartphone screen with the text "Please set on your smartphone" at the top. Below it, it says "Please scan the QR code by using the Leica Camera App, or enter the password in the Wi-Fi settings". There are icons for a camera, a double-headed arrow, and a smartphone. On the right, there is a QR code. At the bottom, there are two input fields: "SSID:" and "Password:". The "SSID:" field is highlighted with a red box.</p> </div>

- Please also refer to the instructions of the device to be connected.

Connecting quickly with the same settings as the previous ones ([Select a destination from History]/[Select a destination from Favorite])

Wi-Fi connection history is saved in History when the Wi-Fi function is used. Connecting from History allows you to easily connect with the same Wi-Fi settings as used previously.

- If the settings of the device to connect to have been changed, it may not be possible to connect to the device.

1 Select the menu item.

MENU → ↗ [Setup] → [Wi-Fi] → [Wi-Fi Function]	
[Select a destination from History]	Connects with previously-used settings.
[Select a destination from Favorite]	Connects with settings registered in Favorites.

2 Select the desired connection setting.

- You can display details of the connection by pressing [DISP].

■ Registering History items to Favorites

① Select the menu item.

MENU → ↗ [Setup] → [Wi-Fi] → [Wi-Fi Function] →
 [Select a destination from History]

② Select the item you wish to register and press ►.

③ Enter a registration name.

- For information on how to enter characters, refer to (→55).
- A maximum of 30 characters can be entered. A two-byte character is treated as two characters.

■ Editing items registered in Favorites

- 1 Select the menu item.

MENU → ↗ **[Setup]** → **[Wi-Fi]** → **[Wi-Fi Function]** →
[Select a destination from Favorite]

- 2 Select the Favorites item you wish to edit and press ►.

[Remove from Favorite]	—
[Change the Order in Favorite]	Select the destination.
[Change the Registered Name]	• How to enter text (→55)

- Because the number of items that can be saved in History is limited, register frequently-used connection settings to Favorites.
 - Performing [Reset Network Settings] deletes data registered in History and Favorites.
 - If the device you want to connect to (smartphone, etc.) is connected to a wireless access point other than the camera, you cannot connect the device to the camera using [Direct]. Change the Wi-Fi settings of the device you want to connect to so that the access point to be used is set to the camera.
- You can also select [New Connection] and reconnect the devices. (→225)

[Wi-Fi Setup] Menu

The items in this menu section serve to configure the settings required for the Wi-Fi function. The settings cannot be changed when connected to Wi-Fi.

MENU → ↗ **[Setup]** → **[Wi-Fi]** → **[Wi-Fi Setup]**

[Priority of Remote Device]

This item allows setting the higher priority between the camera and smartphone to perform operations during remote recording. (→235)

[Wi-Fi Password]

This item allows you to improve security by enabling password entry for a direct connection to a smartphone.

[ON]	Connects the camera and a smartphone using an SSID and password. (→228)
[OFF]	Connects the camera and a smartphone using an SSID. (→230)

• When [ON] is selected, you can also set up a connection by scanning a QR code.

[Device Name]

This item allows you to change the name (SSID) of this camera.

- ❶ Press [DISP].
- ❷ Enter the desired device name.
 - For information on how to enter characters, refer to (→55).
 - A maximum of 32 characters can be entered.

[Wi-Fi Function Lock]

To prevent incorrect operation and use of the Wi-Fi function by a third party and to protect saved personal information, we recommend protecting the Wi-Fi function with a password.

[Setup]	Enter any 4-digit numbers as the password. • For information on how to enter characters, refer to (→55).
[Cancel]	Cancel the password.

- Once a password is set, you are required to enter it each time you use the Wi-Fi function.
- If you forget the password, you can reset it with [Reset Network Settings] in the [Setup] menu.

[Network Address]

This item displays the MAC address and IP address of this camera.

- A MAC Address is a unique address that is used to identify network equipment.
- IP address refers to a number that identifies a computer connected to a network such as the Internet. Usually, the addresses for homes are automatically assigned by the DHCP function such as a wireless access point. (Example: 192.168.0.87)

[Approved Regulations]

The technical compliance standard authentication number is displayed.

Watching/Saving 4K Videos on an External Device

Watching videos in 4K

■ Playing Back on a TV Screen

You can enjoy finely-detailed 4K videos by connecting the camera and a TV that supports 4K video and playing back 4K videos recorded with the camera.

Although the output resolution will be lower, you can also play them back by connecting to a device that does not support 4K video, such as a high-definition TV.

Preparation:

- Set [HDMI Mode (Play)] (→201) to [AUTO] or a resolution of [4K/30p].
- When connecting to a TV that does not support 4K video, select [AUTO].



Connect the camera and a 4K-compatible TV with an HDMI micro cable, and display the playback screen. (→255)

- The TV input will switch automatically and the playback screen will be displayed when you set [HDTV Link] to [ON] and connect to a HDTV Link compatible TV. Refer to (→256) for details.
- You can also play back 4K videos by inserting the card into the SD card slot of a TV that supports 4K.
- Read the instructions for the TV.

■ Watching on a computer

- To play back and edit 4K videos, a high-performance computer environment is required.



Storing 4K videos

You can only dub 4K videos to a Blu-ray disc or DVD with the specific compatibility.

■ Storing 4K videos on your computer

You can use the software available for downloading after registering your camera on the Leica Camera AG homepage to import 4K videos to a computer. (→257)

- For details, refer to the software instructions.

Playing Back on a TV

Preparations: Turn off the camera and the TV.

1 Connect the camera and the TV with an HDMI micro cable.

- Check the plugs orientations and insert them straight. (If they are inserted in the wrong direction, the plug and socket pins could be bent and cause faulty operation.) Also, do not insert into the wrong socket. Doing so may damage the camera.

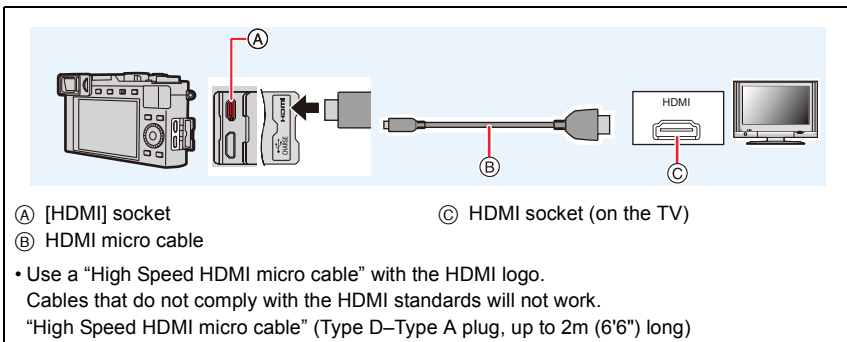

2 Turn on the TV and select the input to match the input source in use.

3 Turn the camera on and then press [▶].

- Depending on the aspect ratio, black bars may be displayed on the top and bottom or the left and right of the TV screen.
- Change the screen mode on your TV if the picture is displayed with the top or bottom cut off.
- Depending on the TV to be connected, video or 4K picture series files may not be played back correctly.
- Check the [HDMI Mode (Play)]. (→201)
- To play back 24p videos, set [HDMI Mode (Play)] to [AUTO]. Otherwise, the picture is not output at 24 frames per second.
- No image will be displayed on the monitor/viewfinder of the camera. In addition, no audio will be output from the speaker of the camera.
- HDMI output will be canceled if a USB cable is connected simultaneously.
- Read the instructions for the TV.

Using HDTV Link (HDMI)

What is the HDTV Link (HDMI) (HDAVI Control™)?

- HDTV Link is a function that automatically links this camera to HDTV compatible devices via HDMI micro cables for enabling easy operation with the HDTV remote control. (Some operations are not available.)
- HDTV Link (HDMI) is an exclusive function added to the industry-standard HDMI control functions known as HDMI CEC (Consumer Electronics Control). Operation is not guaranteed when connecting with other HDMI CEC-compatible devices. Refer to your product's instructions to verify compatibility with HDTV Link (HDMI).

Preparations:

MENU →  **[Setup]** → **[TV Connection]** → **[HDTV Link]** → **[ON]**

- 1 Connect the camera to an HDTV Link (HDMI)-compatible TV with an HDMI micro cable (→255).**
- 2 Turn the camera on and then press .**
- 3 Operate the camera with the remote control for the TV.**

Turning this camera off:

If you use the TV's remote control to turn the TV off, the camera is also turned off.

Automatic input switching:

- If you connect with an HDMI micro cable, turn the camera on, and then press , the input channel on the TV automatically switches to the camera's screen. If the TV's power is in standby status, it will turn on automatically (if [Set] has been selected for the TV's [Power on link] setting).

- Operating the camera using its buttons will be limited.
- To play back the sound of a film during a slide show, set [Sound] to [AUTO] or [Audio] on the Slide Show setting screen.
- Use a "High Speed HDMI micro cable" with the HDMI logo.
Cables that do not comply with the HDMI standards will not work.
"High Speed HDMI micro cable" (Type D–Type A plug, up to 2m (6'6") long)
- Refer to (→279) if HDTV Link is not operating correctly.

Copying the Recorded Image Data to a Computer

With card readers (external)

- Some computers can read directly from the card taken from the camera, others require the use of an external card reader. For details, refer to the instructions of the respective devices.
- If the computer being used does not support SDXC Memory Cards, a message prompting you to format may appear. (Doing so would cause all recorded image data to be erased, so make sure to select [NO].)
- With an external card reader, make sure it supports the type of card being used.

Transferring images to a computer

Preparations:

- Turn on the camera and computer.

1 Connect the computer and camera with the USB cable.

- Turn on the camera and your computer before connecting.
- Check the plugs orientations and insert them straight. (If they are inserted in the wrong direction, the plug and socket pins could be bent and cause faulty operation.) Also, do not insert into the wrong socket. Doing so may damage the camera.
- Do not use any other USB cables except the supplied one.
- A message about charging may be displayed. Wait until the display disappears.

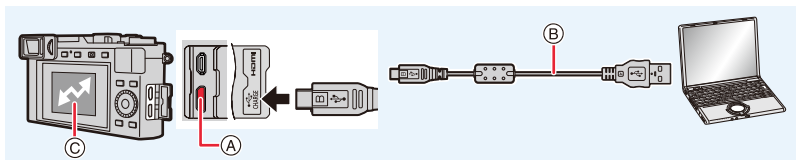

Ⓐ [USB/CHARGE] socket

Ⓑ USB cable

Ⓒ Communicating

- Do not disconnect the USB cable while this is displayed.

2 Press **▲/▼** to select [PC(Storage)], and then [MENU/SET].

- If [USB Mode] is set to [PC(Storage)] in the [Setup] menu in advance, the camera will be automatically connected to the computer without displaying the [USB Mode] selection screen.

- Before removing or inserting the card, turn off the camera and disconnect the USB cable. Otherwise, damage may be caused to the recorded data.
- Use a sufficiently charged battery.
- If the remaining battery power becomes low while the camera and the computer are communicating, the alarm beeps. Disconnect the USB cable safely. Otherwise, data may be destroyed.

■ Copying to your computer without using software

You can drag and drop the folders and files containing the images you want to transfer into separate folders on your computer to save them.

• The content (folder structure) on the card of this camera is as follows.

For Windows: A drive ([LEICA]) is displayed in [Computer]

For Mac: A drive ([LEICA]) is displayed on the desktop

• Card

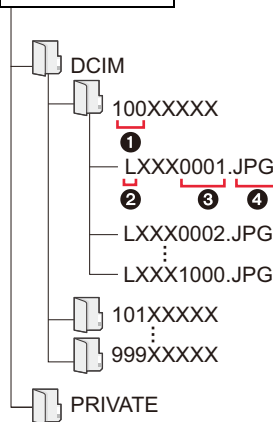

DCIM: Pictures/Videos

- ❶ Folder number
- ❷ Color space L: sRGB
 _: AdobeRGB
- ❸ File number
- ❹ JPG: Pictures
 RW2: Pictures in RAW files
 MP4: [MP4] Videos
 4K picture series files

Saving Pictures and Videos on a Recorder

You can connect the camera to an accordingly equipped Blu-ray disc or DVD recorder and store pictures and videos on it.

1 Connect the recorder and camera with the USB cable.

- Before connecting, turn on the camera and the recorder.
- Check the plugs orientations and insert them straight. (If they are inserted in the wrong direction, the plug and socket pins could be bent and cause faulty operation.) Also, do not insert into the wrong socket. Doing so may damage the camera.
- Do not use any other USB cables except the supplied one.
- A message about charging may be displayed. Wait until the display disappears.

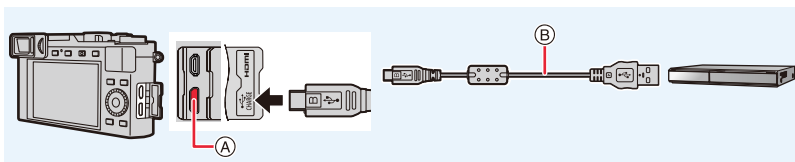

- Ⓐ [USB/CHARGE] socket
- Ⓑ USB cable

2 Press ▲/▼ to select [PC(Storage)], and then [MENU/SET].

- If you set the [USB Mode] to [PC(Storage)] in the [Setup] menu, the [USB Mode] selection screen will not be displayed and the camera will automatically connect to the recorder.

3 Operate the recorder to copy.

- See the instructions for the recorder about the details about copying and playing back.
 - Modes such as 4K video may not be supported depending on the recorder being used.
- Use a sufficiently charged battery or the charger. If the remaining battery power becomes low while the camera and the recorder are communicating, the alarm beeps. In that case, cancel copying immediately. Otherwise, damage may be caused to the data.
- Before removing or inserting the card, turn off the camera and disconnect the USB cable. Otherwise, damage may be caused to the recorded data.

Printing Pictures

You can directly connect the camera to a PictBridge-supported printer for printing.

Preparations:

- Perform the print quality and other settings at the printer before printing the pictures.
- Turn on the camera and the printer.

1 Connect the printer and camera with the USB cable.

- Check the plugs orientations and insert them straight. (If they are inserted in the wrong direction, the plug and socket pins could be bent and cause faulty operation.) Also, do not insert into the wrong socket. Doing so may damage the camera.
- Do not use any other USB cables except the supplied one.
- A message about charging may be displayed. Wait until the display disappears.

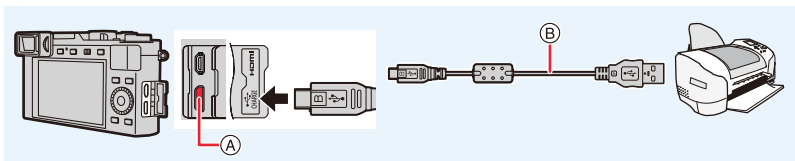

(A) [USB/CHARGE] socket

(B) USB cable

- Do not disconnect the USB cable while [🚫] (Cable disconnect prohibit icon) is displayed.

(May not be displayed depending on the type of printer used.)

- 2 Press ▲/▼ to select [PictBridge(PTP)], and then [MENU/SET].
- 3 Press ◀/▶ to select the picture and then [MENU/SET].
- 4 Press ▲/▼ to select [Print start] and then [MENU/SET].

Selecting multiple pictures and printing them

- 1 Press **▲** to select the multiple printing setting in step 3 of “Printing Pictures” (→261).
- 2 Press **▲/▼** to select an item and then **[MENU/SET]**.

[Multi Select]	Multiple pictures are printed at one time. <ul style="list-style-type: none"> • Press ▲/▼/◀/▶ to select the pictures and then [MENU/SET]. (Press [MENU/SET] again to cancel the setting.) • After the pictures have been selected, press [DISP].
[Select All]	Prints all the stored pictures.
[Rating]	Prints all images with [Rating] levels between [★1] and [★5] .

- 3 Press **▲/▼** to select **[Print start]** and then **[MENU/SET]**.

- Group pictures will not be displayed as group pictures but as single pictures.
- Disconnect the USB cable after printing.
- Use a sufficiently charged battery. If the remaining battery power becomes low while the camera and the printer are connected, the alarm beeps. If this happens during printing, stop printing at once. If not printing, disconnect the USB cable.
- Before removing or inserting the card, turn off the camera and disconnect the USB cable. Otherwise, damage may be caused to the recorded data.
- Some printers can print directly from the card removed from the camera. For details, refer to the instructions of your printer.
- The camera is receiving an error message from the printer when the **[●]** indication lights yellow during printing. After finishing printing, make sure there are no problems with the printer.
- If the number of prints is high, the pictures may be printed several times. In this case, the remaining number of prints indicated may differ from the number set.
- Only pictures taken in JPEG format can be printed. Those taken in RAW will use the JPEG pictures that were simultaneously created. If an equivalent JPEG picture is not available, no print will take place.



Not available in these cases:

- Videos, 4K picture series files, and images recorded with the Post Focus function cannot be printed.

■ Making print settings on the camera

Setting options include the number of printed pictures and their size. Make settings before selecting [Print start].

[Print with Date]	[ON]/[OFF]
[Num.of prints]	Sets number of pictures (up to 999 pictures).
[Paper Size]	Sets the print size.
[Page Layout]	Sets whether or not to add borders and how many pictures to be printed on each sheet of paper.

- If the printer does not support date printing, the date cannot be printed on the picture.
- Depending on the printer, the date print settings of the printer may take precedence so check if this is the case.
- Items not supported by the printer are not displayed.
- When you want to print pictures on a paper size or a layout which is not supported by the camera, set [Paper Size] or [Page Layout] to  and then set the paper size or the layout on the printer.
(For details, refer to the instructions of the printer.)

Adding date and text to pictures

You can use [Text Stamp] in the [Playback] menu to stamp date and time on pictures.

■ Printing date without using [Text Stamp]

In-store printing:

Only the recording date can be printed. Order date printing at a store.

The characters entered using the following menus cannot be printed at a store.

- [Age] and [Name] in [Face Recog.] or [Profile Setup]
- [Location] in [Travel Date]
- [Title Edit]

Printing at home:

When using a printer that supports date printing, you can print the recording date and time by setting [Print with Date] to [ON].

13. Others

Monitor Display/Viewfinder Display

Display example: When [] (monitor style) is set and the monitor display is in use

- The information displayed, such as histograms, magnifications, and numeric values, are only for the purpose of reference.

In recording

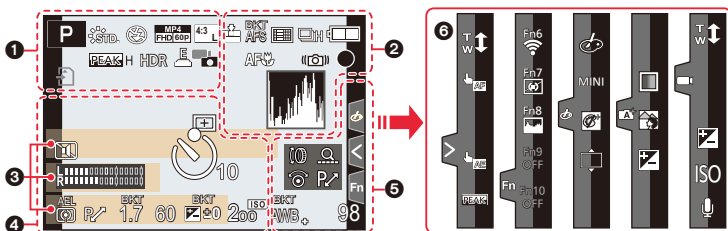













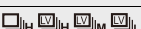





1

	Exposure control mode (→37, 38)
	Video recording mode (→37)
C 1	Custom settings (→70)
	Panorama Shot mode (→117)
	Photo Style (→169)
	Flash Mode (→149)
	Flash (→150)
	Recording quality (→154)
	Aspect Ratio/resolution (→167)
	Picture size (Panorama Shot Mode) (→117)
	Image effect (filter) adjustment display (→126)

EXPS	Image effect (filter) setting (→122)
	Card (displayed only during recording) (→28)
8m30s	Elapsed recording time*1 (→152)
	Simultaneous recording indicator (→156)
LVE/ MONAUTO	Automatic viewfinder/monitor switching (→34)
	Peaking (→188)
	Highlight Shadow (→172)
HDR	HDR (→177)/iHDR (→59)
	Multi exposure (→178)
	Electronic shutter (→176)
	Picture-taking during video recording (Photo Priority) (→156)
	Overheat indicator (→272)









2

	File format/compression rate (→168)
AFS AFF AFC MF	Focusing mode (→74, 87)
	Focus Bracketing (→132)
	AF metering mode (→75)
	Face Recognition (→192)
AFL	AF Lock (→89)
	Serial exposures (→98)
	4K Photo (→100)
	Post Focus (→110)
	Self-timer (→115)
	Panorama direction (→117)
	Battery status (→23)
AF 	Macro recording (→86)
	Image Stabilizer (→139)
	Camera shake alert (→139)
	Focus (Lights green.) (→36)/ Recording state (Flashes red.) (→152)
	Focus (Under low illumination) (→72)
	Focus (Starlight AF) (→72)
	Connected to Wi-Fi
	Connected to Bluetooth (→227)
GPS	Location logging (→241)
	Histogram (→188)

3

Name ^{*2} (→194)
Number of days that have passed since the departure date ^{*3} (→196)
Age ^{*2} (→194)
Location ^{*3} (→196)
Current date and time/Travel destination setting ^{*3} :  (→196)
Exposure meter (→190)
Zoom (→141)

4

	AF area (→81)
+	Spot metering target (→171)
+	Center marker display (→189)
	Self-timer (→115)
	Recording level display (→157)
	Silent mode (→175)
AEL	AE Lock (→89)
	Exposure metering mode (→44, 171)
	Program Shift (→62)
1.7	Aperture value (→36)
	Aperture Bracketing (→131)
60	Shutter speed (→36)
	Exposure compensation value (→90)
	Exposure Bracketing (→131)
	Exposure (→60)
	Manual Exposure Assistance (→67)
	ISO sensitivity (→92)

5

	Dial guide (→186)
	White Balance Bracketing (→132)
	White Balance Fine Adjustment (→96)
	White Balance (→94)
	Color (→60)
98	Number of recordable pictures (→29)
r20	Maximum number of pictures that can be taken continuously (→99)
R8m30s	Available recording time*1 (→29)

6

Touch tab (→185)	
	Touch zoom (→145)
	Touch Shutter (→43)
	Touch AF (→43)
	Touch AE (→44)
	Peaking (→188)
	Function button (→49)
	Color (→60)
	Defocus control function (→60)
	Brightness (→60, 153)
	Type of defocus ([Miniature Effect]) (→125)
	One point color (→125)
	Position of the light source (→126)
	Image effect (filter) adjustment (→128)
	Image effect ON/OFF (→128)
	MINI Image effect (filter) (→128)
	ISO ISO sensitivity (→153)
	Sound recording level adjustment (→153)

*1 m: minutes, s: seconds

*2 This is displayed for about 5 seconds when the camera is turned on if the [Profile Setup] setting is set.

*3 This is displayed for about 5 seconds when the camera is turned on, after setting the clock and after switching from Playback to Recording mode.

On-monitor recording information

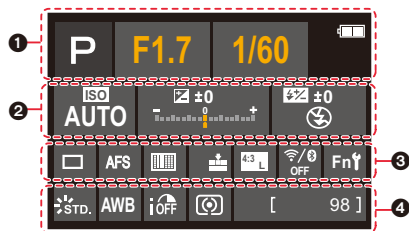

	Exposure control mode (→37)
	Video recording mode (→37)
	Panorama Shot mode (→117)
F1.7	Aperture value (→36)
1/60	Shutter speed (→36)
TIME	Time recording (→68)
	Battery status (→23)
	Card (displayed only during recording)

	ISO sensitivity setting (→92)
	Exposure compensation value (→90)
	Exposure (→60)
	Manual Exposure Assistance (→67)
	Flash mode (→149)
	Flash (→150)

	Single (→97)
	Serial exposures (→98)
	4K Photo (→100)
	Post Focus (→110)
	Self-timer (→115)
	Panorama direction (→117)
	Focusing mode (→74, 87)
	AF metering mode (→75)
	File format/compression rate (→168)
	Aspect ratio/resolution (→167)
	Wi-Fi/Bluetooth (→222)
	Function button setting (→49)

	Photo style (→169)
	White Balance (→94)
	Intelligent Dynamic Range Control (→173)
	Exposure metering mode (→44, 171)
98	Number of recordable pictures (→29)
r20	Maximum number of pictures that can be taken continuously (→99)
R8m30s	Available recording time* (→29)
----	No card

* m: minutes, s: seconds

In playback

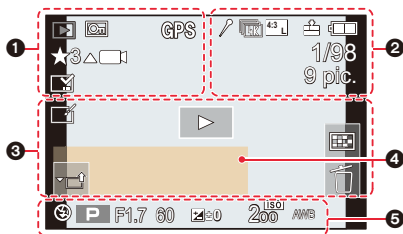

	Playback mode (→207)
	Protected picture (→208)
GPS	Location logging (→241)
★3	Rating (→208)
	Cable disconnect prohibit icon (→261)
	Video playback (→159)
	Save pictures from the 4K picture series file (→105)
	Create pictures from an image recorded with the Post Focus function (→112)
	Play panorama (→120)
	Continuous group picture playback (→164)
	Focus Bracketing (→132, 163)
	Stamped with text indication (→216)
8m30s	Elapsed playback time* ¹ (→159)

	Icon indicating the presence of a marker (→106)
	4K Photo (4K picture series file) (→100)
	Post Focus (→110)
	Focus Stacking (→113)
4.3	Aspect ratio/resolution (→167)
MPEG FHD 60p	Recording quality (→154)

	RAW Quality (→168)
	Battery status (→23)
1/98	Picture number/Total pictures
	Connected to Wi-Fi
9 pic.	Number of group pictures
8m30s	Video recording time* ¹ (→159)

	Clear Retouch completed icon (→215)
	Currently retrieving information icon
	Playback (Videos) (→159)
	Group Display (→164)
	Silent mode (→175)
1ST DAY	Number of days that have passed since the departure date (→196)
	Multi Playback (→162)
	Delete (→165)

4	Name* ² (→192, 194)
	Location* ² (→196)
	Title* ² (→209)
	Age (→192, 194)
5	Recording information

*1 m: minutes, s: seconds

*2 It is displayed in order of [Title], [Location], [Name] ([Baby1]/[Baby2], [Pet]), [Name] ([Face Recog.]).

In playback

Detailed information display

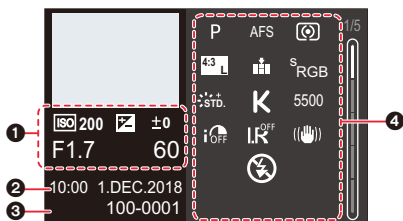

Histogram display

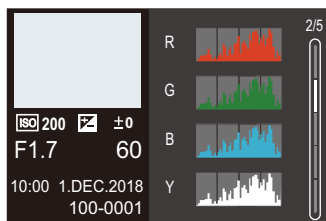
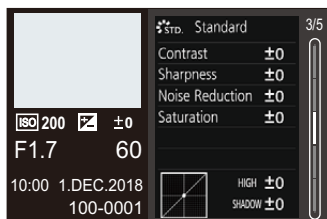
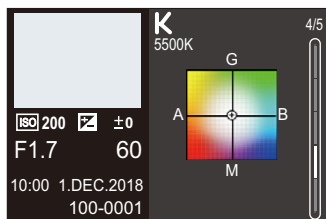

Photo style, Highlight shadow display



White balance display



Lens information display

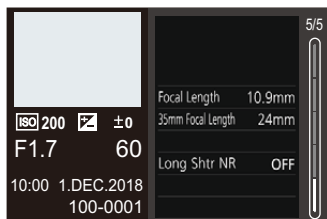

1

Recording information (basic)

2

Recorded date and time/World Time (→195)

3

100-0001 Folder/File number (→259)

4

Recording information (advanced)

5500	White Balance (Color Temperature) (→95)
iOFF	Intelligent Dynamic Range Control (→173)
HDR ON	HDR (→177)/iHDR (→59)
IR ^{OFF}	Intelligent Resolution (→173)

Message Displays

The following explains the meaning of major messages displayed on the screen, and how to respond to them.

■ Memory cards

[Memory Card Error]/[Format this card?]

- Insert a different card.
- Perform formatting (→28) in this camera after saving necessary data on a computer, etc.

[Read Error]/[Write Error]/[Please check the card]

- Remove the card after turning the camera off. Insert the card again, turn the camera on, and try to read or write the data again.
- Check whether card has been inserted correctly. (→26)
 - Insert a different card.

[Recording was cancelled due to the limitation of the writing speed of the card]

- Video recording and recording with the 4K Photo and Post Focus functions require the use of cards with speed class ratings that support the corresponding types of recording. Be sure to use a card of the recommended speed class. (→27)
- If recording stops even when you are using a card that meets the speed class rating, the data writing speed is too slow. We recommend making a backup and then formatting the card (→28).
Depending on the type of the card, recording may stop in the middle.

[Memory Card Error]/[This memory card cannot be used]

- Use a card compatible with this camera. (→27)

■ Battery

[This battery cannot be used]

- Use a genuine Leica battery. Consult your dealer or your nearest Leica Customer Care center if the display still remains.
- Wipe any dirt away from the battery terminals.

■ Wi-Fi function

[Failed to connect wireless access point]/[Connection failed]/[No destination found]

- The wireless access point information set on the camera is wrong.
Check the authentication type, encryption type, and encryption key. (→249)
- It may not be possible to connect to a wireless access point depending on the transmission condition of other devices. Check the status of other devices that are connected to the wireless access point and devices that use the 2.4 GHz frequency.

[Connection failed. Please retry in a few minutes.]/[Network disconnected. Transfer stopped.]

- Transmission from the wireless access point are getting weak.
Perform the connection closer to the wireless access point.
- Depending on the wireless access point, the connection may be automatically disconnected after specific time has passed.
Reconnect the connection again.

[Connection failed]

- Change the access point to connect to in the smartphone Wi-Fi settings to the camera.

■ Others

[Some pictures cannot be deleted]/[This picture cannot be deleted]

- This only with pictures that comply with the DCF standard (→158).
Perform formatting (→28) on this camera after saving necessary data on a computer, etc.

[Cannot be set on this picture]

- Images that do not comply with the DCF standard (→158) cannot be edited on the camera.

[A folder cannot be created]

- A folder cannot be created because there are no remaining folder numbers that can be used.
Perform formatting (→28) on this camera after saving necessary data on a computer, etc.
If you execute [No.Reset] in the [Setup] menu after formatting, the folder number is reset to 100. (→203)

[Please turn camera off and then on again]/[Lens not detected. Please turn camera on again.]/[System Error]

- Turn the camera off and on. If the message is still displayed even after repeating this a few times, contact the dealer where you purchased the camera.

Troubleshooting

First, try out the following procedures (→272 to 280).

If the problem cannot be resolved, it may help to select [Reset] (→203) on the [Setup] menu.

Recording stops before finishing. Recording is not possible. Some functions are not available.

- When the ambient temperature is high or a video is recorded for an extended time, the camera's temperature will rise. In that case, the camera may display [] and then stop the recording or temporarily disable the functions below. Wait until the camera cools down.
 - [4K PHOTO]
 - [Post Focus]
 - [Motion Picture]

Battery and power source

The charging lamp flashes.

- Charging is being performed in a place with extremely high or low temperature.
 - Reconnect the USB cable and retry charging in a place where the ambient temperature is 10°C to 30°C (50°F to 86°F) (temperature conditions also apply to the battery itself).
- Charging is not possible if the power supply capacity of the computer is low.

Camera does not work even if the camera is turned on. Camera switches off as soon as the camera is turned on.

- The battery is exhausted. Charge the battery. (→20)

This camera is turned off automatically.

- [Economy] is enabled. (→198)

The battery becomes flat too quickly.

- When [] ([4K Pre-Burst]) is set for recording, the battery drains faster.
 - Use these functions only when recording with them.
- Is a Wi-Fi connection being used for a long period of time?
The battery can become flat quickly when connected to Wi-Fi.
 - Turn the camera off frequently by using the [Economy] etc. (→198)

Recording

Flicker or horizontal stripes may appear under lighting such as a fluorescent or LED lighting fixtures.

- This is characteristic of MOS sensors like the one in this camera.
This is not a malfunction.
- When using the electronic shutter (→176), lowering the shutter speed may reduce the effect of the horizontal stripes.
- If noticeable flicker or horizontal stripes appear under lighting such as a fluorescent or LED lighting fixtures during video recording, manually adjust the shutter speed to 1/60s or 1/100s. Setting a fixed shutter speed can reduce the flicker or horizontal stripes.



Taking pictures is not possible.

The shutter will not operate immediately when the shutter button is pressed.

- Is [Focus/Release Priority] in the [Custom] menu set to [FOCUS]? (→183)
You cannot take a picture until the subject is brought into focus.

The recorded picture is whitish.

- The lens is dirty (fingerprints, etc.).
→ Turn the camera on to extend lens barrel, and clean the front lens surface with a soft, dry cloth.

The recorded picture is too bright or dark.

- Is the AE Lock (→89) applied incorrectly?

Multiple pictures are taken at one time.

- Drive mode is set to other than [Single]. (→97)
- Are you using the bracketing function? (→129)

The subject is not focused properly.

- The subject is beyond the focusing range of the camera.
- Is [Shutter AF] in the [Custom] menu set to [OFF]? (→181)
- Is [Focus/Release Priority] in the [Custom] menu set to [RELEASE]? (→183)
- Is the AF Lock (→89) applied incorrectly?
- If there are fingerprints or dirt on the front lens, the focus may not be set on the subject.

**The recorded picture is blurred.
The Image Stabilizer is not effective.**

- The shutter speed will become slower and the Image Stabilizer function may not work properly when taking pictures especially in dark places.
→ We recommend using a tripod and the self-timer when taking pictures with a slow shutter speed.

**The recorded picture looks 'grainy'.
Noise appears on the picture.**

- Decrease the ISO sensitivity. (→92)
- Increase the setting for [Noise Reduction] in [Photo Style] or lower the setting for each of the items other than [Noise Reduction]. (→170)
- Set the [Long Shtr NR] to [ON]. (→174)

The subject appears distorted on the picture.

- During recording with the electronic shutter, video recording and 4K photo recording, if you take a picture of a moving subject, it may appear distorted on the picture.
This is characteristic of MOS sensors like the one in this camera. This is not a malfunction.

The brightness or the hue of the recorded picture is different from the actual scene.

- When recording under fluorescent or LED lighting fixtures, etc., increasing the shutter speed may introduce slight changes to brightness and color. These are a result of the characteristics of the light source and do not indicate a malfunction.
- When recording subjects in extremely bright locations or recording under fluorescent lighting, LED lighting fixtures, mercury lamps, sodium lighting, etc., the colors and screen brightness may change or horizontal striping may appear on the screen.

Videos

Recording videos is not possible.

- You may not be able to record for a short while after turning the camera on when using a large capacity card.

Video recording stops in the middle.

- Video recording requires cards with speed class ratings that support particular types of recording. Be sure to use a card of the recommended speed class. (→27)

Sometimes focus adjustment with Autofocus mode is difficult while recording 4K videos.

- This may occur when taking a picture by reducing the Autofocus speed in order to adjust the focus setting with high precision. This is not a malfunction.

In videos, abnormal clicking and buzzing sounds are recorded. The recorded sound is very quiet.

- With recording in a quiet environment, the sound of aperture and focus setting may be recorded in videos. This is not a malfunction. The focus operation during recording of videos can be set to [OFF] in [Continuous AF] (→155).
- While recording videos, if you block the microphone with your fingers, they may reduce the level of audio recording or audio may not record at all. Also be careful because the operation sound of the lens can easily be recorded at this time.

Operating sounds are recorded in a video.

- If the operating sounds made during recording bother you, we recommend changing the relevant setting through touch operations. (→153)
- Since videos are recorded until the video button is pressed again to stop recording, noticeable operating sounds may be heard when they are played back.
To suppress this sound, we recommend trying the following method.
→ Cut off the end part of a video using [Video Divide] (→219) in the [Playback] menu. In some cases, videos cannot be cut off at a position close to the end of the video. To avoid this problem, continue recording for an extra 3 seconds.

Flash

No flash is emitted.

- Flash photography becomes unavailable in the following case.
→ Flash set to [☹]. (→146, 147, 149)
- When the electronic shutter function is used, flash is not activated. (→176)
- When [Silent Mode] is set to [ON], flash is not activated. (→175)

Monitor/Viewfinder

The monitor/viewfinder turns off although the camera is turned on.

- If no operations are performed during the set time period, [Auto EVF/Monitor Off] (→198) is activated, and the monitor/viewfinder turns off.
- When an object or your hand is positioned near the eye sensor, the monitor display may switch to the viewfinder display.

The monitor/viewfinder image may flicker for an instant or the brightness of the screen may change significantly for an instant.

- This occurs due to the aperture of the lens changing when the shutter button is pressed halfway, or when the brightness of the subject changes. This is not a malfunction.

Pressing [EVF] does not switch between the monitor and viewfinder.



- It is only displayed on the monitor when the camera is connected to a computer or printer.

Playback

The picture is not played back. There are no recorded pictures.

- Is the card inserted in the camera?
- Is this a folder or picture which was processed in the computer?
If it is, it cannot be played back by this camera.
→ It is recommended to use the software available for downloading after registering your camera on the Leica Camera AG homepage (→257) to write pictures from computer to card.
- Set [Playback Mode] to [Normal Play]. (→207)

Red part of the recorded image has changed color to black.

- When Red-Eye Removal ([] or []) is performed, red parts may be corrected to black.
→ We recommend recording images with the flash mode set to [] or [Red-Eye Removal] set to [OFF]. (→173)

Wi-Fi function

A Wi-Fi connection cannot be established.

Transmission is interrupted.

The wireless access point is not displayed.

■ General tips for using a Wi-Fi connection

- Use within the communication range of the device to be connected.
- Is any device, such as microwave oven, cordless phone, etc., that uses 2.4 GHz frequency operated nearby?
 - Transmission may get interrupted when used simultaneously. Use them sufficiently away from the device.
- When the battery indicator is flashing red, the connection with other equipment may not start or the connection may be disrupted.
(A message such as [Communication error] is displayed.)
- If you place the camera on a metal table or shelf, the transmission may be adversely affected. In such cases, you may not be able to establish a connection. Move the camera away from the metal surface.

■ About a wireless access point

- Check if the wireless access point to connect is in an operating state.
- Check the transmission condition of the wireless access point.
 - Perform the connection closer to the wireless access point.
 - Change the location and orientation of the wireless access point.
- Depending on the setting of the wireless access point, it may not be displayed even if the transmission exists.
 - Turn off and on the wireless access point.
 - When the network SSID of the wireless access point is set not to broadcast, the wireless access point may not be detected. Enter the network SSID to start the connection (→249) or enable the SSID broadcast of the wireless access point.

The camera is not displayed in the Wi-Fi setting screen of the smartphone.

- From the Wi-Fi setting menu on the smartphone, turn the Wi-Fi function off and back on.

Transmission of the image fails midway. Some images cannot be transmitted.

- Is the file size of the image too large?
 - Transmit after dividing the video with [Video Divide] (→219).
 - Reduce the resolution at [Size] (→246), and then send.
- It may take longer transmit when the distance to the wireless access point is greater.
 - Transmit closer to the wireless access point.
- The file formats of videos that can be sent differ depending on the destination. (→243)

I have forgotten the Wi-Fi password.

- Execute the [Reset Network Settings] in the [Setup] menu. (→204)
However, the information you have set on the [Wi-Fi Setup] or [Bluetooth] will be reset.

TV, computer and printer

No image on the TV. The TV screen is blurred or not colored.

- Is the camera connected to the TV correctly? (→255)
→ Set the input selector of the TV to HDMI.

HDTV Link does not work.

- Is the [HDTV Link] on this camera set to [ON]? (→201)
→ Check the HDTV Link setting on the connected device.
→ Turn the camera off and on.

Cannot communicate with the computer.

- Set to [PC(Storage)] in [USB Mode]. (→200, 258)
- Turn the camera off and on.

The card is not recognized by the computer. (An SDXC memory card is used.)

- Check if your computer is compatible with SDXC memory cards.
- A message prompting to format the card may be displayed when connecting, but do not format.
- If the [Access] displayed on the monitor does not disappear, disconnect the USB cable after turning this camera off.

The picture cannot be printed when the camera is connected to a printer.

- Pictures cannot be printed using a printer that does not support PictBridge.
- Set to [PictBridge(PTP)] in [USB Mode]. (→200, 261)

The ends of the pictures are cut at printing.

- Release any trimming or edgeless printing settings on a printer before printing.
- The aspect ratio of pictures is different from that of the paper used for printing.
→ If printing in a shop, check if 16:9 sizes can be printed.

Others

The lens makes a clicking noise.

- It is a sound of lens movement or aperture operation when the camera is turned on or off. This is not a malfunction.
- This is the sound of automatic aperture adjustment, which occurs when a zoom operation, etc, causes the brightness to change. It is not a malfunction.

Zooming stops instantaneously.

- When using the Extra optical zoom, the zooming action will stop temporarily. This is not a malfunction.

A red lamp sometimes turns on when the shutter button is pressed halfway.

- In dark places, the AF Assist Lamp (→182) lights red to make it easier to focus on a subject.

The camera becomes warm.

- It may become somewhat warm during use, but this does not affect performance or quality.

The clock is reset.

- If you do not use the camera for a long time, the clock may be reset.
→ Reset the clock. (→31)

Usage Cautions and Notes

When in use

Keep the camera as far away as possible from electromagnetic equipment (such as microwave ovens, TVs, video games etc.).

- If you use the camera on top of or near a TV, the pictures and/or sound may be disrupted by electromagnetic fields.
- Do not use the camera near cell phones because doing so may result in noise adversely affecting the pictures and/or sound.
- Recorded data may be damaged, or pictures may be distorted, by strong magnetic fields created by speakers or large motors.
- Electromagnetic fields may adversely affect the camera, disturbing the pictures and/or sound.
- If the camera is adversely affected by electromagnetic equipment and stops functioning properly, turn it off and remove the battery or disconnect the charger. Then reinsert the battery or reconnect the charger and turn the camera on.

Do not use the camera near radio transmitters or high-voltage lines.

- If you record near radio transmitters or high-voltage lines, the recorded pictures and/or sound may be adversely affected.

Always use the supplied cords and cables.

If you use optional accessories, use the cords and the cables supplied with them.

Do not extend the cords or the cables.

Do not keep objects that may be influenced magnetically close to the speaker.

- Magnetized objects such as bank cards, commuter passes, watches, may be adversely affected by the magnetic influence of the speaker.

Do not spray the camera with insecticides or volatile chemicals.

- If the camera is sprayed with such chemicals, the body of the camera may be damaged and the surface finish may peel off.

Cleaning

Before cleaning the camera, remove the battery, and/or disconnect the power plug from the outlet. Then wipe the camera with a dry, soft cloth.

- When the camera is soiled badly, it can be cleaned by wiping the dirt off with a wrung wet cloth, and then with a dry cloth.
- Do not use solvents such as benzine, thinner, alcohol, kitchen detergents, etc., to clean the camera, since it may damage the external casing or the coating may peel off.
- When using a chemical cloth, be sure to follow the accompanying instructions.

When not using the camera for a long period of time

- Always remove the battery and the card from the camera.
- If the battery is left inserted in the camera, it will discharge even if the camera is turned off. If the battery continues to be left in the camera, it will discharge excessively and may become unusable even if charged.
- Do not keep rubber or plastic products in contact with the camera for a long period of time.
- We recommend storing the camera with a desiccant (silica gel) when you keep it in a closet or a cabinet.
- Store the battery in a cool and dry place with a relatively stable temperature: (Recommended temperature: 15°C to 25°C (59°F to 77°F), Recommended humidity: 40%RH to 60%RH)
- When storing the battery for a long period of time, we recommend charging it once a year. Remove the battery out of the camera and store it again after it has completely discharged.
- Check all the parts before taking pictures when you have not used the camera for a long period of time.

About the Monitor/Viewfinder

- Do not press the monitor with excessive force. Uneven colors may appear on the monitor and it may malfunction.
- If the camera is cold when you turn it on, the image on the monitor/viewfinder will be slightly darker than usual at first. However, the image will return to normal brightness when the internal temperature of the camera increases.

Extremely high precision technology is employed to produce the monitor/viewfinder screen. However there may be some dark or bright spots (red, blue or green) on the screen. This is not a malfunction. Though the Monitor/Viewfinder screen parts are produced with highly controlled precision technology, some pixels may be inactive or always lit. The spots will not be recorded on pictures on a card.

About the Lens

- Do not exert excessive force on the lens.
- Images may appear slightly white if the front lens is dirty (fingerprints, etc.). Turn the camera on, hold the extended lens barrel with your fingers, and gently wipe the front lens surface with a soft, dry cloth.
- Do not leave the camera with the lens facing the sun, as light rays from the sun may cause it to malfunction. Also, be careful when placing the camera outside or near a window.

Battery

The battery is a rechargeable lithium ion battery. Its ability to generate power comes from the chemical reaction that takes place inside it. This reaction is susceptible to the surrounding temperature and humidity. If the temperature is too high or too low, the operating time of the battery will become shorter.

Always remove the battery after use.

- Place the removed battery in a plastic bag, and store or keep it away from metal objects (clips, etc.).

Bring along charged spare batteries when going out.

- Be aware that the operating time of the battery becomes shorter in low temperature conditions such as in winter.
- When you travel, do not forget to bring the charger and the USB cable so that you can charge the battery in the country that you are traveling in.

If you drop the battery accidentally, check to see if the body of the battery and the terminals are damaged.

- Inserting a damaged battery in the camera will damage the camera.

Disposal of an unusable battery.

- The battery has a limited life.
- Do not throw the battery into fire because it may cause an explosion.

Do not allow battery terminals to come into contact with metal objects (such as necklaces, hairpins, etc.).

- This can cause short-circuiting or heat generation and you may be badly burned if you touch such a battery.

Charger/AC adapter

- Keep at least 1m (3' 3") away from AM radios (may cause radio interference).
- The charger/AC adapter may generate whirring sounds when it is being used. This is not a malfunction.
- After use, be sure to disconnect the power supply device from the electrical outlet. (A very small amount of current is consumed if it is left connected.)

Card and data

Do not leave the card where the temperature is high, where electromagnetic fields or static electricity are easily generated or exposed to direct sunlight.

Do not bend or drop the card.

- The card may be damaged or the recorded content may be damaged or deleted.
- Put the card in the card case or the storage bag after use and when storing or carrying the card.
- Do not allow dirt, dust, or water to get into the terminals on the back of the card and do not touch the terminals with your fingers.
- Recorded data may be damaged or lost if the camera breaks down due to inappropriate handling. Leica Camera AG will not be liable for any damage caused due to loss of recorded data.

■ Notice for when transferring to another party, or disposing of the memory card

- **Formatting or deleting using the camera or a computer will only modify the file management information, it will not erase the data in the memory card completely.**
- **It is recommended to physically destroy the memory card or use the commercially available computer data deletion software to completely erase the data in the memory card before transferring to another party or disposing.**
- **Management of data in the memory card is the responsibility of the user.**

About tripods or unipods

- When you use a tripod, make sure the tripod is stable when the camera is attached to it.
- You may not be able to remove the card or the battery when using a tripod or unipod.
- Make sure that the screw on the tripod or unipod is not at an angle when attaching or detaching the camera. You may damage the thread in the camera if you use excessive force when turning it. Also, the camera body and the rating label may be damaged or scratched if the camera is attached too tightly to the tripod or unipod.
- Read the instructions for the tripod or unipod.

About the personal information

We recommend that you enable [Wi-Fi Password] and [Wi-Fi Function Lock] to protect personal information. (→253)

If a name or birthday is set for [Profile Setup]/Face Recognition function, this personal information is kept in the camera and recorded in the image.

Be sure to pay special attention to the privacy, i.e. personal rights, etc. of a subject and take your own responsibility when you use the [Silent Mode], or use functions such as writing the location information and changing the shutter noise, etc.

Disclaimer

- Information including personal information may be altered or be deleted due to erroneous operation, the effects of static electricity, an accident, a malfunction, a repair, or others. Please note in advance that Leica Camera AG is not liable in any way for any direct or indirect damage from the alteration or deletion of information or personal information.

When requesting a repair, transferring to another party, or disposing.

- After making a copy of personal information, always delete information such as personal information and wireless LAN connection settings that you have saved within the camera with [Reset Network Settings] (→204).
- Reset the settings to protect the personal information. (→203)
- Remove the memory card from the camera when requesting a repair.
- Settings may return to factory default when camera is repaired.
- If the above operations cannot be performed because of a camera malfunction, consult your dealer or the nearest Leica Customer Care department.

When transferring to another party, or disposing of the memory card, please refer to “Notice for when transferring to another party, or disposing of the memory card”. (→284)

When uploading images on web services

- Images may contain information that can be used for identifying individuals such as titles, recording dates, and location information. When uploading images on web services, check carefully, and then upload.

Wi-Fi function

■ Use of the camera as a wireless LAN device

When using equipment or computer systems that require more reliable security than wireless LAN devices, ensure that the appropriate measures are taken for safety designs and defects for the systems used. Leica Camera AG will not take any responsibility for any damage that arises when using the camera for any purpose other than as a wireless LAN device.

■ Use of the Wi-Fi function of the camera is presumed to be in countries where this camera is sold

There is the risk that the camera violates the transmission regulations if used in countries other than those where this camera is sold, and Leica Camera AG takes no responsibility for any violations.

■ There is the risk that data sent and received via transmission may be intercepted

Please note that there is the risk that data sent and received via radio waves may be intercepted by a third party. We strongly recommend that you set an encryption to maintain information security.

■ Do not use the camera in areas with magnetic fields, static electricity or interference

- Do not use the camera in areas with magnetic fields, static electricity or interference, such as near microwave ovens. These may cause the interruption of the transmission.
- Using the camera near devices such as microwave ovens or cordless telephones that use the 2.4 GHz transmission band may cause a decrease in performance in both devices.

■ Do not connect to a wireless network you are not authorized to use

When the camera utilizes its Wi-Fi function, wireless networks will be searched for automatically. When this happens, wireless networks that you are not authorized to use (SSID*) may be displayed, however do not attempt to connect to such a network as it may be considered as attempted unauthorized access.

- * SSID refers to the name that is used to identify a network over a wireless LAN connection. If the SSID matches for both devices, transmission is possible.

- The SDXC Logo is a trademark of SD-3C, LLC.
- The terms HDMI and HDMI High-Definition Multimedia Interface, and the HDMI Logo are trademarks or registered trademarks of HDMI Licensing Administrator, Inc. in the United States and other countries.
- Dolby, Dolby Audio, and the double-D symbol are trademarks of Dolby Laboratories.
- Leica is a registered trademark of Leica Microsystems IR GmbH.
- Summilux is a registered trademark of Leica Camera AG.
- Adobe is a trademark or registered trademark of Adobe Systems Incorporated in the United States and/or other countries.
- Windows is either registered trademark or trademark of Microsoft Corporation in the United States and/or other countries.
- iMovie, Mac, OS X and macOS are trademarks of Apple Inc., registered in the U.S. and other countries.
- iPad, iPhone, iPod, and iPod touch are trademarks of Apple Inc., registered in the U.S. and other countries.
- App Store is a service mark of Apple Inc.
- Android and Google Play are trademarks or registered trademarks of Google Inc.
- The Bluetooth® word mark and logos are registered trademarks owned by the Bluetooth SIG, Inc. and any use of such marks by Leica Camera AG is under license. Other trademarks and trade names are those of their respective owners.
- The Wi-Fi CERTIFIED™ Logo is a certification mark of Wi-Fi Alliance®.
- The Wi-Fi Protected Setup™ Logo is a certification mark of Wi-Fi Alliance®.
- “Wi-Fi®” is a registered trademark of Wi-Fi Alliance®.
- “Wi-Fi Protected Setup™”, “WPA™”, and “WPA2™” are trademarks of Wi-Fi Alliance®.
- QR Code is a registered trademark of DENSO WAVE INCORPORATED.
- This product uses “DynaFont” from DynaComware Corporation. DynaFont is a registered trademark of DynaComware Taiwan Inc.
- Other names, company names, and product names mentioned in these instructions are trademarks or registered trademarks of the companies concerned.



This product is licensed under the AVC Patent Portfolio License for the personal use of a consumer or other uses in which it does not receive remuneration to (i) encode video in compliance with the AVC Standard ("AVC Video") and/or (ii) decode AVC Video that was encoded by a consumer engaged in a personal activity and/or was obtained from a video provider licensed to provide AVC Video. No license is granted or shall be implied for any other use. Additional information may be obtained from MPEG LA, L.L.C.

See <http://www.mpegla.com>

This product incorporates the following software:

- (1) the software developed independently for Leica Camera AG,
- (2) the software owned by third party and licensed to Leica Camera AG,
- (3) the software licensed under the GNU General Public License, Version 2.0 (GPL V2.0),
- (4) the software licensed under the GNU LESSER General Public License, Version 2.1 (LGPL V2.1), and/or
- (5) open source software other than the software licensed under the GPL V2.0 and/or LGPL V2.1.

The software categorized as (3) - (5) are distributed in the hope that it will be useful, but WITHOUT ANY WARRANTY, without even the implied warranty of MERCHANTABILITY or FITNESS FOR A PARTICULAR PURPOSE. Please refer to the detailed terms and conditions thereof displayed by selecting [MENU/SET] → [Setup] → [Version Disp.] → [Software info]

Leica Service Addresses

Leica Product Support

The Leica Product Support department can provide you with answers to any technical questions relating to Leica products, including software supplied, either in writing, on the telephone or by e-mail.

It is also the contact point for purchasing advice and to order instructions.

Alternatively, you can send us your questions using the contact form on the Leica Camera AG homepage.

Leica Camera AG
Product Support / Software Support
Am Leitz-Park 5
D-35578 Wetzlar

Telephone: +49 (0) 6441-2080-111 /-108

Fax: +49 (0) 6441-2080-490

info@leica-camera.com / software-support@leica-camera.com

Leica Customer Care

For servicing your Leica equipment or in the event of damage, the Leica Camera AG Customer Care department or the repair service provided by authorized Leica agents in your country are available (for addresses, see the Leica Camera AG homepage).

Leica Camera AG
Customer Care
Am Leitz-Park 5
D-35578 Wetzlar

Telephone: +49 (0) 6441-2080-189

Fax: +49 (0) 6441-2080-339

customer.care@leica-camera.com



DAS WESENTLICHE.

Leica Camera AG | Am Leitz-Park 5

35578 WETZLAR | DEUTSCHLAND

Telefon +49(0)6441-2080-0 | Telefax +49(0)6441-2080-333

www.leica-camera.com

LEICA FOTOS

The camera can be controlled remotely using a smartphone/tablet PC. This will require an installation of the Leica FOTOS app on the mobile device.

- ▶ Scan the following QR code with the mobile device



or

- ▶ The app is available from Apple App Store™/Google Play Store™

CONNECTION

FIRST-TIME CONNECTION TO A MOBILE DEVICE

The connection is established via Bluetooth. A pairing of the camera and the mobile device is required for a first-time connection to a mobile device.

CONNECTION WIZARD

The connection wizard appears at initial startup of the camera or after a camera reset. These settings are also available via the menu item **Leica FOTOS**.

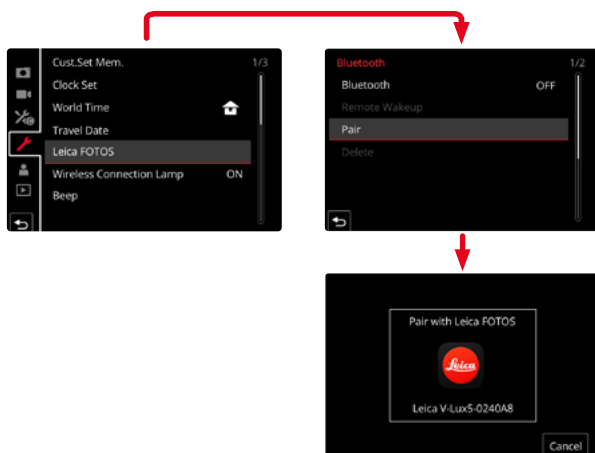

USING THE MENU TO

ON THE MOBILE DEVICE

- ▶ Activate Bluetooth
- ▶ Launch the Leica FOTOS app
- ▶ Select the camera model

IN THE CAMERA

- ▶ Select **Leica FOTOS** in the main menu
- ▶ Select **Bluetooth**
 - Bluetooth is activated.
- ▶ Follow the Leica FOTOS instructions
 - The relevant icons appear on the LCD panel and the status LED lights in blue once a connection is established successfully.

Notes

- The pairing process may take a few minutes to complete.
- Each mobile device only needs to be paired with the camera once. The process adds the device to the list of known devices.
- GPS data will be automatically determined and written to the Exif data when pictures are taken while the camera is connected to the Leica FOTOS app.

CONNECTING TO KNOWN DEVICES

- ▶ Select **Leica FOTOS** in the main menu
- ▶ Select **Bluetooth**
- ▶ Select **On**
 - Activate the Bluetooth function.
 - The camera connects to the mobile device automatically.

Notes

- Should there be more than one known device in the vicinity of the camera, then it will automatically connect to the first device responding. A favorite mobile device cannot be specified.
- We recommend removing rarely used devices from the list of known devices to prevent unwanted connections.
- Disconnect and reconnect (i.e. deactivating and reactivating Bluetooth in the camera) if the wrong device was connected.

REMOVING DEVICES FROM THE LIST OF KNOWN DEVICES

- ▶ Select **Leica FOTOS** in the main menu
- ▶ Select **Delete**
- ▶ Select the relevant device
 - A security prompt appears on the LCD panel.
- ▶ Select **Yes**

Note

- The pairing process will have to be repeated to reconnect a deleted device to the camera.

FIND THE MAC ADDRESS

You can find the MAC address of the Leica SL2 in the camera menu.

- ▶ Select **Camera Information** in the main menu

REMOTE CAMERA CONTROL

You can take pictures and record video remotely via the mobile device, and can also change image settings or transfer data to the mobile device. A list of available functions and instructions for their use can be found in the Leica FOTOS app.

REMOTE CAMERA ACTIVATION

The camera can be activated remotely from off or standby if this function is activated in the camera. The Bluetooth function must be active.

- ▶ Select **Leica FOTOS** in the main menu
- ▶ Select **Remote Wakeup**
- ▶ Select **On**
 - The camera will scan for known devices and automatically establishes a connection.

Important information

- Remote activation will activate the camera even if it was switched off via the main switch.
- Accidental remote camera activation may result in unwanted pictures taken and excessive power consumption.
- A third-party device can – provided it has been paired with the camera – access the camera remotely if your own mobile device is not currently connected or its Bluetooth function is deactivated. This poses a danger of unauthorized access to your data or camera functions.

Solution

- Only activate this function just before you want to use it.
- Disable the function as soon as it is no longer needed.